



“PRODUCTS THAT CARE”

For more than 35 years, JVD has been committed to offering protection and care. Care for you, your health and your comfort. But also protection for your environment. We create and manufacture products that make sense, for both you and our planet.

PRODUCTS FOR EVERYONE, EVERYWHERE AND FOR A LONG TIME

All our products are developed and tested by our teams to ensure user comfort and well-being, anytime, anywhere. The kind of objects people handle every day without really thinking about them, from the now iconic hand dryers to soap dispensers.

At each hotel, restaurant, café, airport and office, JVD's collective hygiene and wellness equipment is there for all the moments that make up our daily lives. Many of our products are certified sustainable, made in France (in Rezé) and respectful of our planet, to preserve it for the generations to come.



JVD.COM.SG QR CODE



THE FRENCH KNOW-HOW

Based in Nantes, in the west of France, JVD is the leading designer and manufacturer of hygiene and hotel equipment and solutions. Backed by our unique know-how, our company has now expanded into more than 100 countries around the world.



COMMITTED TO YOU AND THE PLANET

JVD is dedicated to the idea of transmission, and our teams make it a point of honour to work hard each day towards an ecological transition which looks out for everyone's well-being.



Which is why, in an era where planned obsolescence has become the norm, we are committed to designing sustainable products for our clients. We also prioritize partners located as close as possible to our production unit so as to reduce the environmental impact of our transport.

We believe in the role we have to play in our shared future. So, it is only natural that we see eco-responsibility as one of the key pillars of our strategy today.

CONTENTS

HAIR DRYERS
P.5 > P.19

KETTLES & TRAYS
P.20 > P.23

IRON CENTER
P.37 > P.46

ROOM ACCESSORIES
P.47 > P.57

SAFES
P.58 > P.64

MINIBARS
P. 65 > P.75

BATHROOM
P.76 > P.99

HYGIACARE
P.100 > P.110

HSK & OTHERS
P.111 > P.119

HYGIENE
P.120 > P.126



OUR HAIR DRYERS

Our hair dryers are elegant and easy to handle, designed to offer maximum comfort to your guests: a good grip on a sturdy accessory, packed with technology for gentle yet efficient drying and a design that leaves no one cold.

ALTEO CHROME
REF 8 22 1139

PAGES
5 TO 19

BATHROOM BASICS

APPRECIATED BY MORE THAN 2/3 OF SURVEYED GUESTS

Long obligatory at 4-star and higher hotels, hair dryers are now becoming increasingly crucial for any hotel. According to a study by the CMHF (Committee for the Modernization of French Hotels), They are the bathroom accessory which guests miss the most when not available. Additionally, the CMHF revealed that: «Guests, particularly female guests, are very fond of them. It means they do not have to bring their own, which is necessarily impractical when travelling.»



CHOOSING THE RIGHT HAIR DRYER

A QUESTION OF POWER?

Contrary to preconceptions, the choice of a hair dryer is not a question of power. Although power can be a good indicator, some appliances are designed to yield a superior quality of drying despite having less power and so using less energy. In addition, very hot, powerful drying is not suitable to all hair types. As a result, it is important to offer solutions to guests which allow them to adjust the speed and heat of the hair dryer. Solutions which allow guests to adjust the speed and heat of the hair dryer.

IONIZING SYSTEM

Some hair dryers include an ionizing system. The generated ions neutralize the static electricity that can appear on hair while drying it. This lower temperature system greatly improves the speed of drying. The generated ions neutralize static electricity.

CONSTRAINTS SPECIFIC TO HOTELS

FOR EVERYONE'S SAFETY

A hotel's hair dryers are not subject to the same constraints as hair dryers marketed to the general public. Outside the strict standards which must be met, hotel hair dryers may sometimes be used in unintended ways (theft, to dry clothes, shoes, etc.). And so they should be designed to limit those uses (e.g. JVD LighTouch handle, timer, anti-theft protection, etc.). They should also fit stylishly into bathrooms by means of a dedicated support which can also be used to offer shaver sockets suitable for an international clientele.

WHERE SHOULD A HAIR DRYER GO?

To protect your guests against the risk of electrocution, standard NF C 15-100 defines the required distance between electrical appliances and the main water tap (bathtub or shower). Only hair dryers with hoses can be installed close to them (volume area ②). All other devices must be installed as well as possible in volume area ③.

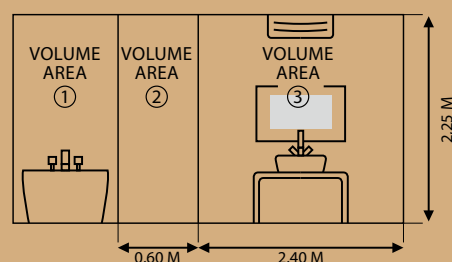

THE LIGHTOUCH® RANGE

DESIGNED TO RESPOND SPECIFICALLY TO HOW HAIR DRYERS ARE USED IN HOTELS. THE PATENTED 'LIGHTOUCH' HANDLE HAS ALREADY WON OVER THOUSANDS OF HOTELS AROUND THE WORLD.

ALTEO PLUS



ALTEO PLUS
Black 1 875 W
+ curly cord & plug
REF 8 22 1044



ALTEO PLUS
White 1 875 W
+ curly cord & plug
REF 8 22 1043



WALL SUPPORT HOLDER
Zinc Alloy, Chrome
REF 8 66 1269

HIGHLIGHTS

- + Power 1875W
- + Patented LighTouch® handle which switches on by gently squeezing the handle
- + Fitted with a negative ionizer for frizz-free hair

CHARACTERISTICS

- Power: 220~240V, 50/60Hz
- Power rating: 1875W
- Patented LighTouch® handle
- 2 airflow settings
- 3 temperatures with cold shot
- In-built negative ionizer
- Spiral cord 40cm extendable
- Over-heating protection
- Removable nozzle & back filter
- Isolation electric Class II
- Dim. H205/L245/D84mm
- 12 units per carton

CHARACTERISTICS

- Wall Support Holder
- Anti-theft cable fixation
- Holds cable cord
- Zinc alloy, Chrome finishing
- 60 units per carton

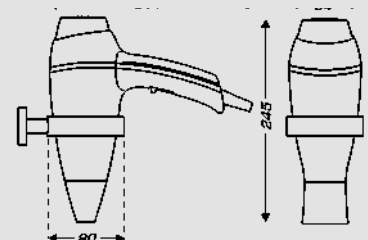

BRITTONY PLUS



BRITTONY
Black 1 600 W
+ curly cord & plug
REF 8 22 1047



BRITTONY
White 1 600 W
+ curly cord & plug
REF 8 22 1046

BRITTONY PLUS + HOLDER



BRITTONY
Black 1 600 W
+ wall-mounted holder
REF 8 22 1050



BRITTONY
White 1 600 W
+ wall-mounted holder
REF 8 22 1049



WALL SUPPORT HOLDER
Zinc Alloy, Chrome
REF 8 66 1220

HIGHLIGHTS

- + 1 600 W power
- + Patented LighTouch® handle which switches on by simply picking it up
- + Fitted with a negative ionizer for frizz-free hair

CHARACTERISTICS

- Power: 220~240V, 50/60Hz
- Power rating: 1600W
- Patented LighTouch® handle
- 2 airflow settings
- 3 temperatures with cold shot
- In-built negative ionizer
- Spiral cord 40cm extendable
- Over-heating protection
- Removable nozzle & back filter
- Isolation electric Class II
- Dim. H196/L210/D75mm
- 12 units per carton

CHARACTERISTICS

- Wall Support Holder
- Anti-theft cable fixation
- Holds cable cord
- Zinc alloy, Chrome finishing
- 60 units per carton

EDEN PLUS



EDEN PLUS
Black 1 200 W
+ curly cord & plug
REF 8 22 1069



EDEN PLUS
White 1 200 W
+ curly cord & plug
REF 8 22 1068

EDEN PLUS + HOLDER



EDEN PLUS
Black 1 200W
+ wall-mounted holder
REF 8 22 1071 BK-WHD



EDEN PLUS + WALL MOUNTED HOLDER
WHITE 1 200 W
+ wall-mounted holder
REF 8 22 1070



WALL SUPPORT HOLDER
Zinc Alloy, Chrome
REF 8 66 1270

HIGHLIGHTS

- + Compact 1200W
- + Patented LighTouch® handle which switches on by gently squeezing the handle

CHARACTERISTICS

- Power: 220~240V, 50/60Hz
- Power rating: 1200W
- Patented LighTouch® handle
- 3 drying settings with cold shot
- Spiral cord 40cm extendable
- Over-heating protection
- Removable back filter
- Isolation electric Class II
- Dim. H190/L150/D70mm
- Wall support H190/L150/D100mm
- 12 units per carton

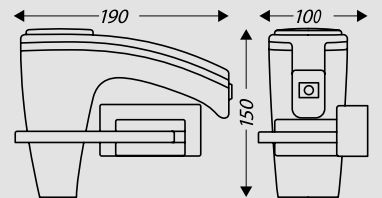
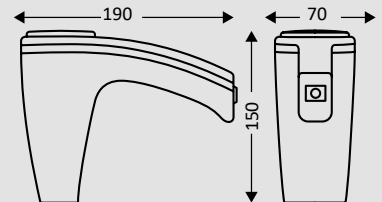

CHARACTERISTICS

- Wall Support Holder
- Anti-theft cable fixation
- Holds cable cord
- Zinc alloy, Chrome finishing
- 60 units per carton



REF 8 22 2107

AN ON/OFF BUTTON AND MORE CLASSIC DESIGN MEAN THERE ARE NO SURPRISES HERE. THE HAIR DRYERS IN THIS RANGE MAKE GUESTS FEEL LIKE THEY'RE HOME.

CALISTO



CALISTO
Matt Black 2000W
+ curly cord & plug
REF 8 22 1412

HIGHLIGHTS

- + Very long life (digital / brushless motor)
- + Power: 2000 W
- + Fitted with an ionizing system

CHARACTERISTICS

- Power: 220~240V, 50/60Hz
- Power rating: 2000W
- Long-life brushless motor
- On/off trigger switch system
- 2 airflow settings
- 3 temperature settings with cold shot
- In-built negative ionizer
- Spiral cord 40cm extendable
- Over-heating protection
- Removable nozzle & back filter
- Isolation electric Class II
- Dim. H266/L262/D89mm
- 12 units per carton

AMOR



AMOR
Black 1800W
+ straight cord & plug
REF 8 22 1564

HIGHLIGHTS

- + Power: 1800 W
- + Fitted with an ionizing system for frizz-free hair

CHARACTERISTICS

- Power: 220~240V, 50/60Hz
- Power rating: 1800W
- DC motor
- On/off trigger switch system
- 2 airflow settings
- 3 temperature settings with cold shot
- In-built negative ionizer
- Straight cord 2 metre with plug
- Over-heating protection
- Removable nozzle & back filter
- Isolation electric Class II
- Dim. H265/L219/D94mm
- 12 units per carton

BOBINO



BOBINO
Matt Black 1400W
+ curly cord & plug
REF 8 22 1680



- Compact yet powerful
- 1400W
- With cold shot

HIGHLIGHTS

- + Compact 1400W design
- + Anti-radiation system

CHARACTERISTICS

- Power: 220~240V, 50/60Hz
- Power rating: 1400W
- On/off power system
- DC motor
- 3 airflow-temp. settings with cold shot
- Spiral cord 40cm extendable
- Over-heating protection
- Removable nozzle and back filter
- Isolation electric Class II
- Matt black finishing
- Dim. H233/L168 /D94mm
- 12 units per carton

PICCOLO PRO



PICCOLO PRO
White 1200W
+ curly cord & plug
REF 8 22 1500



PICCOLO PRO
Black 1200W
+ curly cord & plug
REF 8 22 1501



PICCOLO PRO
Black 1200W
+ wall-mounted holder
REF 8 22 1503

HIGHLIGHTS

- + Compact 1200W
- + With cold shot

CHARACTERISTICS

- Power: 220~240V, 50/60Hz
- Power rating: 1200W
- On/off trigger switch system
- DC motor
- 3 airflow-temp. settings with cold shot
- Spiral cord 40cm extendable
- Over-heating protection
- Removable back filter
- Isolation electric Class II

Ref. 822 1500/ 822 1501
- Dim. H207/L145/D72mm
- 16 units per carton

Ref. 822 1503
- Holder with built-in power micro-switch
- Auto power off when place in holder
- Dim. H258/L165/D94mm
- 16 units per carton

IBIZA



IBIZA
Black 1800~2000W
+ straight cord & plug
REF 8 22 919



IBIZA
Matt Black 1800~2000W
+ curly cord & plug
REF 8 22 919-MB-CU



IBIZA
Chrome 1800~2000W
+ straight cord & plug
REF 8 22 919 CHR



IBIZA
White 1800~2000W
+ straight cord & plug
REF 8 22 918



IBIZA
Rose Copper 1800~2000W
+ straight cord & plug
REF 8 22 919 RCP

HIGHLIGHTS

- + Long-life AC motor
- + Fitted with an ionizing system for frizz-free hair
- + 2 power range;
1800W~2000W

CHARACTERISTICS

- Power range:
1800W~2000W
- Long-life AC motor
- On/off trigger switch system
- 2 airflow settings
- 3 temperature settings with cold shot
- In-built negative ionizer
- Spiral cord 40cm extendable or
Straight cord 2 metre with plug
- Over-heating protection
- Removable nozzle & back filter
- Isolation electric Class II
- Dim. H266/L273/D96mm
- 12 units per carton

IBIZA 1800W-2000 Models

- 822918 WH (White + straight cord)
- 822919 BK (Black + straight cord)
- 822919 BK-CU (Black + curly cord)
- 822919 MB-CU (Matt Black + curly cord)
- 822919 RCP (Rose Copper + straight cord)
- 822919 CHR (Chrome + straight cord)

AC MOTOR

- Long-life AC motor
- Ionizing system
- High power
- On/Off range

ROLLEO FOLDABLE



ROLLEO
Matt Black 1750~2100W
+ retractable cord & plug
REF 8 22 1679



Retractable cord
Compact storage

HIGHLIGHTS

- + Power range: 1750W-2100W
- + Fitted with an ionizing system for frizz-free hair
- + Retractable cord

CHARACTERISTICS

- Power: 220~240V, 50/60Hz
- Power range: 1750W-2100W
- DC motor
- On/off trigger switch system
- 3 airflow-temp. settings with cold shot
- In-built negative ionizer
- Retractable cord 1.74 metre
- Over-heating protection
- Removable nozzle & back filter
- Isolation electric Class II
- Folded H148/L281/D97mm
- Unfolded H238/L281/D97mm
- 12 units per carton

UNO FOLDABLE



UNO
Matt Black 2000W
+ straight cord & plug
REF 8 222 096-MB



HIGHLIGHTS

- + High Power Performance: 2000W
- + Fitted with an ionizing system for frizz-free hair
- + Foldable

CHARACTERISTICS

- Power: 220~240V, 50/60Hz
- Power rating 2000W
- DC motor
- Slider switch system
- 3 airflow including cold shot
- Tourmaline ionic
- Straight cord 2m
- Over-heating protection
- Removable nozzle
- Isolation electric class II
- Folded H115/L153/D75mm
- Unfolded H240/L153/D75mm
- 12 units per carton

LINEO FOLDABLE



LINEO
White 1600W
+ curly cord & plug
REF 8 22 1329

KEOS FOLDABLE



KEOS
Matt Black 1800W
+ curly cord & plug
REF 8 22 1499-MB



KEOS
White 1600W
+ curly cord & plug
REF 8 22 1498

CORAL FOLDABLE



CORAL
White 1600W
+ curly cord & plug
REF 8 22 818



CORAL
Black 1600W
+ curly cord & plug
REF 8 22 827

HIGHLIGHTS

- + Power 1600W
- + Fitted with an ionizing system for frizz-free hair
- + Foldable

CHARACTERISTICS

- Power: 220~240V, 50/60Hz
- Power rating 1600W
- On/off trigger switch system
- DC motor
- 2 airflow, 3 temperature settings
- With cold shot, built-in ionizer
- Spiral cord 40cm extendable
- Over-heating protection
- Removable nozzle & back filter
- Isolation electric Class II
- Folded H133/L244/D89mm
- Unfolded H289/L244/D89mm
- 12 units per carton

HIGHLIGHTS

- + Power 1600W & 1800W
- + Foldable
- + Cold shot

CHARACTERISTICS

- Power: 220~240V, 50/60Hz
- Power rating: 1600W & 1800W
- DC motor
- On/off trigger switch system
- 3 airflow-temp. settings with cold shot
- Spiral cord 40cm extendable
- Over-heating protection
- Removable nozzle
- Removable back filter
- Isolation electric Class II
- Folded Dim. H138/L194/D78mm
- Unfolded Dim. H251/L194/D78mm
- 16 units per carton

HIGHLIGHTS

- + Power 1600W
- + Foldable
- + Cold shot

CHARACTERISTICS

- Power: 220~240V, 50/60Hz
- Power rating: 1600W
- DC motor
- On/off trigger switch system
- 3 airflow-temp. settings with cold shot
- Spiral cord 40cm extendable
- Over-heating protection
- Removable back filter
- Isolation electric Class II
- Folded Dim. H117/L183/D78mm
- Unfolded Dim. H229/L183/D78mm
- 16 units per carton

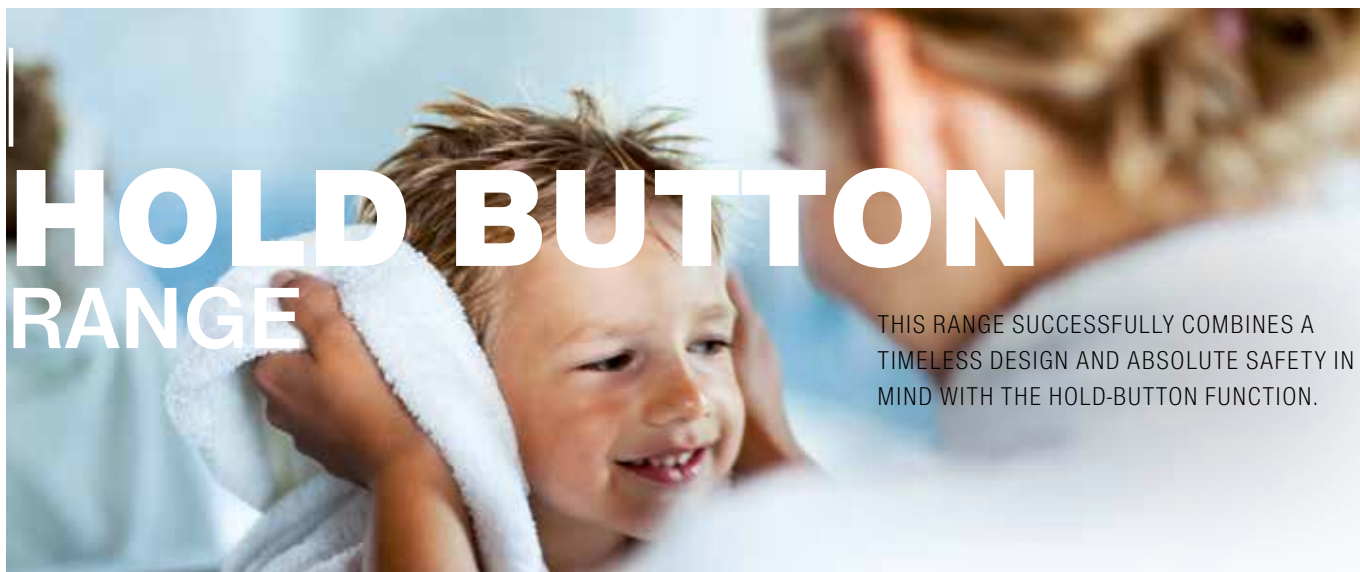

THIS RANGE SUCCESSFULLY COMBINES A TIMELESS DESIGN AND ABSOLUTE SAFETY IN MIND WITH THE HOLD-BUTTON FUNCTION.

CLIPPER DC



CLIPPER DC
Black 1600W
+ curly cord & plug
REF 8 22 204

CLIPPER SC



CLIPPER SC
White 1 600 W
+ curly cord & plug
REF 8 22 191



CLIPPER SC
Black 1 600 W
+ curly cord & plug
REF 8 22 192

HIGHLIGHTS

- + Safety Hold Button



CHARACTERISTICS

- Voltage 220~240V, 50/60Hz
- Power rating: 1600W
- Hold button safety system
- 3 drying settings
- With cold shot
- Spiral cord 40cm extendable
- Over-heating protection
- Isolation electric Class II
- 16 units per carton

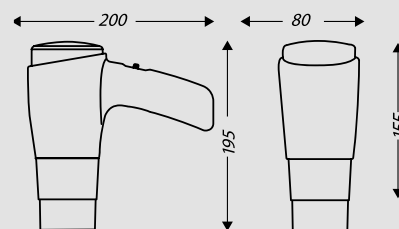

OCEANIS WALL MOUNT



OCEANIS DC
Black 1600W
+ wall holder
REF 8 22 414

CHARACTERISTICS

- Holder with on/off switch
- Power: 220~240V, 1600W
- Hold button safety system
- 3 drying settings with cold shot
- Spiral cord 40cm extendable
- Over-heating protection
- Electrical insulation Class II
- 12 units per carton

CLIPPER WALL MOUNT



CLIPPER SC 1 600 W
+ Wall holder
REF 8 22 178



CLIPPER SC 1 600 W
+ Wall holder
REF 8 22 179

CHARACTERISTICS

- Single Chrome
- Power: 220~240V, 50/60Hz
- Power 1600W
- Hold button safety system
- 3 drying settings
- With cold shot
- Spiral cord 40cm extendable
- Over-heating protection
- Isolation electric Class II
- 12 units per carton

OCEANIS PR



OCEANIS PR 1600W
Black 1 600 W
+ Shaver unit wall holder
REF 8 22 407



Available in shaver
unit dual voltage
115V /230V

HIGHLIGHTS

- + Power 1600W
- + Hold button safety system
- + Holder with on/off switch
- + Shaver dual voltage 115V/230V

CHARACTERISTICS

- Power: 220~240V, 50/60Hz, 1600W
- Hold button safety system
- Holder with on/off switch
- Shaver unit dual voltage 115V/230V
- 3 airflow-temp. settings with cold shot
- Spiral cord 40cm extendable
- Over-heating protection, Class II
- Dim. H255/L230/D135mm
- 12 units per carton

KEOS PR



KEOS PR
White 1 600 W
+ Shaver wall holder
REF 8 22 1668



KEOS PR
Black 1600W
+ Shaver wall holder
REF 8 22 1667



Available in shaver
unit dual voltage
115V /230V

HIGHLIGHTS

- + Power 1600W
- + On/off trigger switch system
- + Built-in power microswitch holder
- + Shaver dual voltage 115V/230V

CHARACTERISTICS

- Power: 220~240V, 50/60Hz
- Power rating: 1600W
- On/off trigger switch system
- Shaver unit dual voltage 115V/230V
- Holder with built-in power micro-switch
Auto power off when placed in holder
- DC motor
- 3 airflow-temp. settings with cold shot
- Spiral cord 40cm extendable
- Over-heating protection
- Removable back filter
- Isolation electric Class II
- Dim. H235/L190/D95mm
- 12 units per carton

PICCOLO PRO PR



PICCOLO PRO PR
Black 1 200 W
+ Shaver wall holder
REF 8 22 1505



Available in shaver
unit dual voltage
115V /230V

HIGHLIGHTS

- + Power 1200W
- + On/off trigger switch system
- + Shaver dual voltage 115V/230V

CHARACTERISTICS

- Power: 220~240V, 50/60Hz
- Power rating: 1200W
- On/off trigger switch system
- Shaver unit dual voltage 115V/230V
- DC motor
- 3 airflow-temp. settings with cold shot
- Spiral cord 40cm extendable
- Over-heating protection
- Removable back filter
- Isolation electric Class II
- Dim. H170/L162/D95mm
- 12 units per carton

ALPINO SUPPORT



ALPINO L
Chrome
REF 8 66 1269



ALPINO M/S
Chrome
REF 8 66 1220/
REF 8 66 1270



ANTI-THEFT
Cable attached to wall

HIGHLIGHTS

- + 2-in-1: anti-theft solution + support
- Possibility of locking the power cord to the chrome wall support

CHARACTERISTICS

- Zinc and plastic alloy
- Rust resistance
- Cable hook & anti-theft design
- 60 units per carton

REF: 8 66 1269
Support for Alteo, Calisto, Ibiza, Amor

REF: 8 66 1220/1270
Support for Brittany, Eden

CAROUSOL SUPPORT



CAROUSOL HOLDER
PP, TRANSLUCENT
REF 8 66 1506



ANTI-THEFT
Cable attached to wall



HIGHLIGHTS

- + 2-in-1: anti-theft solution + support
- Possibility of locking the power cord to the wall support

CHARACTERISTICS

- Strong PP in translucent finishing
- Cable hook & anti-theft design
- Suitable for Alteo, Calisto, Ibiza, Amor
- 60 units per carton

HAIR DRYER BAG



VELVET BAG
Black
REF 2 402 841



COTTON BAG
Black
REF 2 502 412



NON-WOVEN BAG
Black
REF 2 402 903



NON-WOVEN BAG
White
REF 2 402 902/
REF 2 402 904

HIGHLIGHTS

- + Compatible with all JVD hair dryers
- + Double looped drawstring closes by simply pulling on it

CHARACTERISTICS

- VELVET with embroidery
2 40 2841 - 310/310mm, Black

- NON-WOVEN with print
2402902, 260/260mm, White
2402904, 310/310mm, White
2402903, 310/310mm, Black

- COTTON with print
2502412, 310/310mm, Black

- 50 units per carton

THE HOSE RANGE

REF 8 22 278

A MUST FOR ANY ENVIRONMENT WITH SIGNIFICANT ELECTRICAL SAFETY CONSTRAINTS (VOLUME AREA 2). THIS RANGE BOASTS THE HIGHEST SECURITY INDEXES ON THE MARKET (IP44/43) AND COMPACT DIMENSIONS SO THEY CAN FIT INTO ANY BATHROOM.

CARAÏBE



CARAÏBE
White 1100W
REF 8 22 278

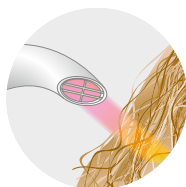

Concentrator design for fast dry

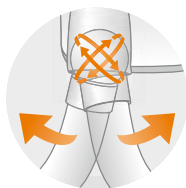

Swivel design facilitate easy movement and maximise life span

HIGHLIGHTS

- + The most compact in the market
- + Highest IP rating on the market
- + Patented handle to simplify styling

CHARACTERISTICS

- Power supply: 220~240V, 50/60Hz
- Power: 1100W
- Swivel handle for optimum life span
- Airflow: 80 m3/hr
- Installation volume 2
- Isolation electric Class II
- IP 44 safety Index
- 12 units per carton

DIMENSIONS

- Main unit H230/L140/D150mm

HAWAI



HAWAI
White 1000W
+ timer + shaver
REF 8 22 421

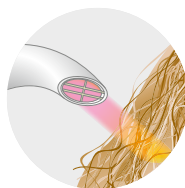

Concentrator design for fast dry

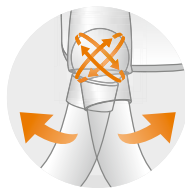

Swivel design facilitate easy movement and maximise life span

HIGHLIGHTS

- + Adjustable airflow
- + Dual voltage shaver unit
- + 15 minutes timer control

CHARACTERISTICS

- Power supply: 220~240V, 50/60Hz
- Power: 1000W
- Swivel handle for optimum life span
- Airflow: 80 m3/hr
- Installation volume 2
- Isolation electric Class II
- IP 34 safety Index
- 6 units per carton

DIMENSIONS

- Main unit H250/L195/D128mm
- Hose L45cm extendable to 135cm
- Hose diameter outer 40mm

GLITZ E
REF 8 66 2153-BRZ

OUR KETTLES & WELCOME TRAYS

Elegance, design and ergonomics: the threefold expectations which inspire our products. Over a cup of hot chocolate, tea or coffee, each moment becomes a time of comfort, relaxation and well-being.

MINI CORSETO
REF 8 66 1612

PAGES
20 TO 29

EVERYTHING YOU NEED TO KNOW TO CHOOSE THE RIGHT PRODUCT

KETTLES

With a combination of functionality, elegance and clever technology, our kettles will be able to accompany your guests' morning wake-up routines and moments of relaxation. Conceived specifically for hotels, they are also easy on your teams.

TRAYS

The essential accessory to showcase your welcome products and to put the final touch of design on your rooms. Our broad range of trays ensure there is something to suit any environment. With the possibility of incorporating the base of one of our kettles, they combine to form a perfect whole.

ESPRESSO MACHINES

Our machines are designed to offer a simple solution which will make delicious espresso for your guests. No need for a dedicated space: thanks to their small size, they can fit anywhere. The options offered by our espresso machines provide something for any urge, any moment and any guest.



A WORD FROM THE DESIGNER

"In recent years, we have witnessed a profound change in hotel room design. We have shifted from often stereotypical settings to places for experiences.

For guests, the time spent there should be atypical, personal and sometimes even surprising. Our products' design further contributes to this new trend.

Arranged in increasingly varied environments, they add their own aesthetic touches whilst either fitting in seamlessly or boldly standing out. Naturally, in addition to their decorative aspects, each object must also offer services specific to a hotel room, in a way which is efficient, robust, safe and faithful to the hotel's philosophy. They should be simple, universal and ergonomic in their use. Our products are inspired by this twofold expectation of practicality and aesthetics."

Jean-Guy de Russé

DIVA 1L DOUBLE WALL



HIGHLIGHTS



DOUBLE WALL
Quieter, holds heat longer, no risk of burns



HYGIENIC
Inner wall & lid made of 100% stainless steel



SAFE
Auto shutoff by simply gripping the Switchsafe® handle



EASY TO OPEN
Opens with one hand thanks to an assisted opening lid



EASY TO CLEAN
Wide opening makes it easy to clean

CHARACTERISTICS

- Power: 220~240V, 50/60Hz
- Power rating: 1500W
- Capacity 1.0 litre
- Double-wall, cool touch
- Interior S/S304
- Auto off when boiled or empty
- 360° rotation on the base
- Concealed heating element
- Power light
- Dim. H213/L145/D210mm
- 6 units per carton



DIVA 1 L
Black
REF 8 66 1341



DIVA 1 L
White
REF 8 66 1342

SAISONS 1L DOUBLE WALL



SAISONS 1 L
Matt Black
REF 8 66 1665



SAISONS 1 L
Sand Gold
REF 8 66 1693

HIGHLIGHTS



DOUBLE WALL
Quieter, holds heat longer, no risk of burns



HYGIENIC
Inner wall & lid made of 100% stainless steel

CHARACTERISTICS

- Power: 220~240V, 50/60Hz
- Power rating: 800-950W
- Capacity 1.0 litre
- Double-wall, cool touch
- Interior S/S304
- Auto off when boiled or empty
- 360° rotation on the base
- Concealed heating element
- Water level indicator
- Power light
- Dim. H230/L195/D155mm
- 12 units per carton

TITAN 1.5L DOUBLE WALL



Titan 1.5 L
Matt Black
REF 8 66 1835



Protection from heat



Wide-opening for easy cleaning

HIGHLIGHTS



DOUBLE WALL
Quieter, holds heat longer, no risk of burns



HYGIENIC
Inner wall & lid made of 100% stainless steel

CHARACTERISTICS

- Power: 220~240V, 50/60Hz
- Power rating: 1500W
- Capacity 1.5 litre
- Double-wall, cool touch
- Interior S/S304
- Auto off when boiled or empty
- 360° rotation on the base
- Concealed heating element
- Power light
- Dim. H242/L200/D140mm
- 12 units per carton

GLITZE 1L DOUBLE WALL



GLITZE 1L
TURQUOISE BLUE
REF 8 66 2156-TQB

HIGHLIGHTS



DOUBLE WALL
Quieter, holds heat longer, no risk of burns



COLOURFUL
Available in 4 finishes



HYGIENIC
Inner wall & lid made of 100% stainless steel

CHARACTERISTICS

- Power: 220~240V, 50/60Hz
- Power rating: 1360W
- Capacity 1.0 litre
- Double-wall, cool touch
- Rust resistant metal housing
- Interior S/S304
- Auto off when boiled or empty
- 360° rotation on the base
- Concealed heating element
- Power light
- Dim. H225/L200/D115mm
- 12 units per carton

Ref 8 66 2156-TQB
Turquoise Blue finish

Ref 8 66 2152-SS
S/S Matt finish

Ref 8 66 2153-BRZ
Bronze finish

Ref 8 66 2135-NB
Nickel Black finish



GLITZE 1 L
S/S BRUSHED
REF 8 66 2152-SS



GLITZE 1L
BRONZE
REF 8 66 2153-BRZ



GLITZE 1L
NICKEL BLACK
REF 8 66 2135-NB

AZURE 0.8L DOUBLE WALL



AZURE 0.8 L
Matt Black
REF 8 66 1829-MB



Seamless S/S304
inner body

HIGHLIGHTS



DOUBLE WALL
Quieter, holds heat longer, no risk of burns



HYGIENIC
Inner wall & lid made of 100% stainless steel

CHARACTERISTICS

- Power: 220~240V, 50/60Hz
- Power rating: 1000W
- Capacity 0.8 litre
- Double-wall, cool touch
- Interior S/S304
- Auto off when boiled or empty
- 360° rotation on the base
- Concealed heating element
- Power light
- Dim. H200/L190/D130mm
- 12 units per carton

ENVOYE 0.6L DOUBLE WALL



ENVOYE 0.6 L
Black
REF 8 66 1827



ENVOYE 0.6 L
White
REF 8 66 1828

HIGHLIGHTS



DOUBLE WALL
Quieter, holds heat longer, no risk of burns



HYGIENIC
Inner wall & lid made of 100% stainless steel

CHARACTERISTICS

- Power: 220~240V, 50/60Hz
- Power rating: 800W
- Capacity 0.6 litre
- Double-wall, cool touch
- Interior S/S304
- Auto off when boiled or empty
- 360° rotation on the base
- Concealed heating element
- Power light
- Dim. H170/L168/D110mm
- 18 units per carton



CHARME ICE Bucket
REF 8 99 1030

CHARME Turndown/kettle Tray
REF 8 99 1717

CHARME Sachet Tray
REF 8 66 1020

DUCHESSÉ 0.8 L & 1.0 L



REF 8 66 914



DUCHESSÉ 0,8 L
S/S Matt
REF 8 66 914



DUCHESSÉ 1 L
S/S Matt
REF 8 66 916

HIGHLIGHTS

- + Classic design
- + JVD SwitchSafe® handle
- + Designed for fixation with JVD Zen Line & Maestro welcome trays



EASY TO CLEAN
+ Thanks to its 90° opening

CHARACTERISTICS

- Power: 220~240V, 50/60Hz
- Power range: 1100-1310W
- 0.8L, Dim. H197/L209/D128mm
- 1.0L, Dim. H189/L206/D146mm
- JVD patented Switchsafe® handle
- Auto off when boiled or empty
- 360° rotation on the base
- Concealed heating element
- Power light
- Can be fitted with with Zen & Maestro trays (anti-theft)
- 12 units per carton

Safety Features

- Equipped with thermo-fuse
- 3 way safety cut-off

LUXE 1L



LUXE 1 L
S/S Matt
REF 8 66 1682



LUXE 1 L
S/S Rose Copper
REF 8 66 1683

HIGHLIGHTS

- + Fast boiling time
- + Wide opening, easy to clean

CHARACTERISTICS

- Power: 220~240V, 50/60Hz
- Power range: 1850-2200W
- Capacity 1.0 litre
- Strix controller
- Auto off when boiled or empty
- 360° rotation on the base
- Concealed heating element
- Water level indicator
- Power light
- Dim. H210/L190/D115mm
- 8 units per carton

KINGSLEY 1L



KINGSLEY 1 L
S/S Matt
REF 8 66 2157-SS



KINGSLEY 1 L
Matt Black
REF 8 66 2157-MB

HIGHLIGHTS

- + Fast boiling time
- + Wide opening, easy to clean

CHARACTERISTICS

- Power: 220~240V, 50/60Hz
- Power range: 1850-2200W
- Capacity 1.0 litre
- Auto off when boiled or empty
- 360° rotation on the base
- Concealed heating element
- Water level indicator
- Power light
- Dim. H205/L210/D142mm
- 12 units per carton



KINGSLEY 1 L
Matt Black
REF 8 66 2157-MB

Mini-Corso
REF 8 66 1612

CHARME Drawer Tray
REF 8 99 1712

OXFORD 1.7 L



OXFORD 1.7 L
S/S Matt
REF 8 66 2155

HIGHLIGHTS

- + Fast boiling time
- + Wide opening, easy to clean

CHARACTERISTICS

- Power range: 1850-2200W
- Capacity 1.7 litre
- Auto off when boiled or empty
- 360° rotation on the base
- Concealed heating element
- Water level indicator
- Power light
- Dim. H230/L215/D115mm
- 12 units per carton

SOHO 1L



HIGHLIGHTS

- + Easy to clean with wide opening
- + ABS body with attractive stainless steel rim
- + Interior S/S304

CHARACTERISTICS

- Power: 220~240V, 50/60Hz
- Power range: 1350 -1500W
- Capacity 1.0L
- Auto off when boiled or empty
- 360° rotation on the base
- Concealed heating element
- Water level indicator
- Power light
- Dim. H190/L223/D135mm
- 16 units per carton



SOHO 1 L
Black
REF 8 66 2154



CONTINENTAL TRAY
Black
REF 8 66 2161

DUCHESSÉ 0.8L & 1L



DUCHESSÉ
0.8 L Black
REF 8 66 1011



DUCHESSÉ
0.8 L Ivory
REF 8 66 1012



DUCHESSÉ
1 L Black
REF 8 66 1014



DUCHESSÉ
1 L White
REF 8 66 1013



TRAYS
A wide range of fitted trays



POWER OFF
Made easy by simply gripping the Switchsafe® handle



EASY TO CLEAN
Thanks to a wide opening and a hidden element

HIGHLIGHTS

- + JVD SwitchSafe® handle
- + Designed for fixation with JVD Zen Line & Maestro welcome trays

CHARACTERISTICS

- Power: 220~240V, 50/60Hz
- Power range: 1100 -1310W
- Capacity 0.8L
- JVD patented Switchsafe® handle
- Auto off when boiled or empty
- 360° rotation on the base
- Concealed heating element
- Water level indicator
- Power light
- Designed for fixation with JVD trays
- Dim. H190/L223/D135mm
- 12 units per carton

CHARACTERISTICS

- Power: 220~240V, 50/60Hz
- Power range: 1100 -1310W
- Capacity 1L
- JVD patented Switchsafe® handle
- Auto off when boiled or empty
- 360° rotation on the base
- Concealed heating element
- Water level indicator
- Power light
- Designed for fixation with JVD trays
- Dim. H205/L223/D135mm
- 12 units per carton

CHARACTERISTICS

- Odourless
- 100% biodegradable
- Non-toxic, natural citrique acide
- Simple usage to remove stains
- 700g per tub
- Approx. 90 times usage
- 6 units per carton

KETTLE DESCALER



DESCALER
REF 8 88 1555

- Odourless
- 100% biodegradable
- Non-toxic, natural citrique acide
- Simple usage to remove stains
- 700g per tub
- Approx. 90 times usage
- 6 units per carton

CHARME



REF 8 66 1018
REF 8 66 1020

CHARME Main tray
Faux leather, Black
REF 8 66 1018

CHARME Sachet tray
Faux leather, Black
REF 8 66 1020



CHARME Sachet tray
Faux leather, Beige
REF 8 66 1021



CHARME Main tray
Faux leather, Black
REF 8 66 1018



CHARME Main tray
Faux leather, Beige
REF 8 66 1019

DRAWER TRAY



CHARME Main tray
Faux leather, Black
REF 8 99 1713



HIGHLIGHTS



ELEGANCE
Topstitched seam

⊕ Hand-crafted PU leather made into different forms exuding class, luxury and a timeless style.

CHARACTERISTICS

Ref: 8661018/ 019
- Main Tray
- PU leatherette
- Black and Beige color
- H32/L400/W290mm
- 12 units per carton

Ref: 8661020/ 021
- Sachet Tray
- PU leatherette
- Black and Beige color
- H63/L165/D83mm
- 60 units per carton

CHARACTERISTICS

Ref: 8991713
- Drawer Tray
- PU leatherette, Black color
- Main Tray H70/W300/D200mm
- Drawer H35/L280/D190mm
- 16 units per carton

MAESTRO COMBO



MAESTRO Combo
Black
REF 8 66 1698



HIGHLIGHTS

- + Classy organizer for kettle, spoons, mugs, and other refreshments
- + High quality melamine in polish black finishing

CHARACTERISTICS

- High quality melamine
- Heat and stain resistant
- Kettle + 6 storage compartments
- Designed for most kettles with bases not exceeding 17 cm Ø
- Overall dim. H50/L410/D279mm
- 12 units per carton

MAESTRO



Cups + Saucer
White
REF 8 66 1158

Tray + Kettle Fixation
White
REF 8 66 1157

HIGHLIGHTS

- + Designed to fit a good selection of JVD kettles
- + Deters kettles loss (anti-theft)
- + High quality melamine
- + With matching cups and saucers
- + Certified food grade

CHARACTERISTICS

- High quality melamine material
- Certified food grade
- Heat and stain resistant
- With anti-theft option

- Tray dim. H27/L395/D197mm
- 36 units per carton

- Cup with saucer dim. H105/20mm
- 60 units per carton

WHITE COLOR

- 8 66 1156 Main Tray
- 8 66 1157 Main Tray with kettle fixation
- 8 66 1158 Cups & Saucers

IVORY COLOR

- 8 66 1159 Main Tray
- 8 66 1160 Main Tray with kettle fixation
- 8 66 1161 Cups & Saucers

BLACK COLOR

- 8 66 1162 Main Tray
- 8 66 1163 Main Tray with kettle fixation
- 8 66 1164 Cups & Saucers



Tray, Ivory
REF 8 66 1159



Cups + Saucer
Ivory
REF 8 66 1161



Tray, Black
REF 8 66 1163



Cups + Saucer
Black
REF 8 66 1164

ZEN LINE II



REF 8 66 394

REF 8 66 893

REF 8 66 891



ZEN LINE Sachet tray
Ivory, 5 compartments
REF 8 66388

ZEN LINE Main tray
Ivory
REF 8 66 888

ZEN LINE Small Sachet
Ivory, 4 compartments
REF 8 66389

ZEN LINE Service tray
Ivory
REF 8 66 890



ZEN LINE BLACK



ZEN LINE Tray + Fixation
Black
REF 8 66 892



ZEN LINE WHITE



ZEN LINE Tray + Fixation
White
REF 8 66 886

HIGHLIGHTS



Designed to fix a good selection of JVD kettles to the Main Tray

CHARACTERISTICS

- High quality melamine material
- Certified food grade
- Heat and stain resistant
- Anti-theft fixation option to deter kettle loss

Dimensions

- Main Tray H25/L377/D298mm (upc 16 pcs)
- Service Tray H10/L295/D155mm (upc 48 pcs)
- Sachet Tray H49/L215/D144mm (upc 48 pcs)
- Small Sachet H49/L152/D115mm (upc 48 pcs)

White Color

- 8 66 885 Main Tray
- 8 66 886 Main Tray with kettle fixation
- 8 66 887 Service Tray
- 8 66 383 Sachet Tray 5 compartments
- 8 66 384 Small Sachet 4 compartments

Ivory Color

- 8 66 888 Main Tray
- 8 66 889 Main Tray with kettle fixation
- 8 66 890 Service Tray
- 8 66 388 Sachet Tray 5 compartments
- 8 66 389 Small Sachet 4 compartments

Black Color

- 8 66 891 Main Tray
- 8 66 892 Main Tray with kettle fixation
- 8 66 893 Service Tray
- 8 66 393 Sachet Tray 5 compartments
- 8 66 394 Small Sachet 4 compartments

VOYAGER



GLITZE 1L
Turquoise Blue
REF 8 66 2156 - TQB

VOYAGER
White Trays



VOYAGER Service tray
Ivory
REF 8 66 065

VOYAGER Sachet tray
Ivory
REF 8 66 066

VOYAGER Main tray
Ivory
REF 8 66 064



VOYAGER
Black Trays



CHARACTERISTICS

- High quality melamine material
- Certified food grade
- Heat and stain resistant

Dimensions

- Main Tray H25/L400/D330mm
16 units per carton
- Service Tray H17/L315/D145mm
72 units per carton
- Sachet Tray H50/L100/D100mm
72 units per carton

WHITE COLOR

- 8 66 163 Main Tray
- 8 66 164 Service Tray
- 8 66 165 Sachet Tray

IVORY COLOR

- 8 66 064 Main Tray
- 8 66 065 Service Tray
- 8 66 066 Sachet Tray

BLACK COLOR

- 8 66 074 Main Tray
- 8 66 075 Service Tray
- 8 66 076 Sachet Tray

CONTINENTAL

GLITZE 1L
S/S Matt
REF 8 66 2152-SS

CONTINENTAL Tray



CONTINENTAL Tray
Black
REF 8 66 2161



Anti-theft



HIGHLIGHTS

- + Attractively designed
- + High quality ABS
- + Anti-theft feature

CHARACTERISTICS

- High quality ABS material
- Compact and efficient
- Designed for most kettles with bases
not exceeding 17cmØ
- Dim. H40/L250/D250mm
- Matt black wood grain finish
- 20 units per carton

OUR ROOM ACCESSORIES

In JVD's hospitality universe, accessories make each room unique and transform a hotel stay into an experience in and of itself. Every day, we innovate to provide hotel guests with accessories that combine functionality, technology, safety and ergonomics.

BEACON
REF 8 66 1574

LUGGAGE RACK
REF 8 66 1530

DOUBLE WALL BIN
REF WBU-3 00 516

MINI CORSETO



MINI CORSETO
White
REF 8 66 1613



MINI CORSETO
Red
REF 8 66 1614

HIGHLIGHTS



PRACTICAL
+ Tank is easy to remove and clean



EASY
+ Just 2 buttons for intuitive use



ADJUSTABLE
+ Cup support compatible with small and large cups

CHARACTERISTICS

- Voltage 220V ~ 240V, 50/60 Hz
- Power 1400W
- Manual capsule insertion
- Auto eject when lid is lifted
- Removable 0.8l water tank
- Drawer for 10 used capsules
- Adjustable temperature
- Dim. H255/W155/L330mm
- Weight 2.8 Kg
- 4 units per carton

ACCESSORIES



CHARME Large Drawer Tray
Black
REF 8 99 1712



CHARME Capsule Holder
Black
REF 8 99 1701



HIGHLIGHTS

+ Hand-crafted PU leather made into different forms exuding class, luxury and a timeless style.

CHARACTERISTICS

- Faux leather (PU)
- Non-slip footing

Large Drawer Tray

- Tray Dim. H80/W400/D330mm
- Drawer Dim. H47/W380/D320mm
- 4 compartments
- Good depth to place most compact espresso machines
- 8 units per carton

Capsule Holder

- Dual sided insert; 2 or 4 capsules at each side
- Capsule 20mm Ø
- Dim. H47/L120/D120mm
- 24 units per carton

TOASTERS



SAHARA
S/S Housing
REF 8 66 1350



SAHARA
S/S Black
REF 8 66 1350-BK



HIGHLIGHTS

- + Looks great on any kitchen top
- + High lift for easy toast removal
- + Easy cleaning with removable crumb tray
- + Easy to use, classic defrost, reheat and cancel functions

CHARACTERISTICS

- Power: 220~240V, 50/60Hz
- Power rating: 780-930W
- Stainless steel housing
- 2 bread slices capacity
- Reheat/defrost/cancel function
- Removable crumb tray
- High lift to remove crumbs
- Dim. H188/L265/D156mm
- 6 units per carton

ACCESSORIES



SAHARA Cover
Black
REF 8 66 1575



CHARACTERISTICS

- Polyester quilted fabric
- Classical diamond shaped stitching
- Heat resistant aluminium foam inner liner
- Oversized to fit comfortably
- Dim. H200/L290/D200mm
- 50 units per carton

VELYSS STEAMER CUM IRON



VELYSS
Dark Grey
REF 8 66 1773



Wall-mounted holder with hook allows wall-mounting or hanging for easy storage



Easy water filling:
1. Press water tank to dislodge
2. Retrieve water tank
3. Fill with water
4. Push water tank inwards to affix



+ EASY TO STORE



+ 300 ML WATER TANK



+ CERAMIC SOLEPLATE

HIGHLIGHTS

- + Easy 2 pre-set steam output
- + Generates steam within 30 seconds
- + Automatic power off
- + Eliminate bacteria
- + With hanging/wall mounted holder

CHARACTERISTICS

- 220-240V, 50/60Hz, 1500W
- Constant steam temperature 110°C
- Up to 30g/mins of steam output
- Steam penetration removes creases
- Generates steam within 30 seconds
- Filter sponge and high temperature
- Help to eliminate bacteria
- Easy 2 pre-set steam output level
- Auto power-off after 5 min. of inactivity
- Ceramic soleplate
- Transparent water tank 300ml
- Purpose-built wall holder with hook
- Mounting or hanging for easy storage
- Power cord & steam cord 1.8m
- 6 units per carton

DIMENSIONS & WEIGHT

- Steamer H310/W100/D90mm, 0.67kg
- Holder H450/W125/D130mm, 1.87kg

SCAN TO VIEW PRODUCT VIDEO

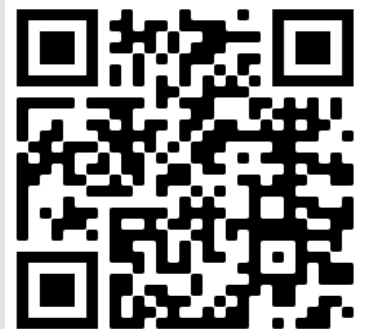

VINCI 2200W



VINCI 2200W
Ceramic Soleplate
Black
REF 8 66 1115-CM



HIGHLIGHTS

- + Automatic power-off;
Horizontal position after 30 seconds
Vertical position after 8 minutes
- + Anti-drip, anti-calc
- + With 'smart-wrap' Velcro

CHARACTERISTICS

- Power: 220~240V, 50/60Hz
- Power rating: 2200W
- Ceramic soleplate
- Automatic power-off system;
Horizontal position after 30 seconds
Vertical position after 8 minutes
- Dry, steam, spray and burst functions
- Anti-drip, anti-calc
- Self-cleaning function
- Fabric guide indicator
- Water tank capacity 280ml
- Cable length 2m
- With 'smart-wrap' Velcro
- Weight 1.1 Kg
- Dim. H149/L295/D121mm
- 10 units per carton

VIVO II 2000W



VIVO 2 000 W
Stainless Steel Soleplate
Dark Grey
REF 8 66 923-SS (2000W)



VIVO 2 000 W
Ceramic Soleplate
Dark Grey
REF 8 66 923-CM (2000W)

HIGHLIGHTS

- + Automatic power-off;
Horizontal position after 30 seconds
Vertical position after 8 minutes
- + Anti-drip, anti-calc
- + With 'smart-wrap' Velcro

CHARACTERISTICS

- Power: 220~240V, 50/60Hz
- Power rating: 2000W
- Ceramic and stainless steel soleplate
- Automatic power-off system;
Horizontal position after 30 seconds
Vertical position after 8 minutes
- Dry, steam, spray and burst functions
- Anti-drip, anti-calc
- Self-cleaning function
- Fabric guide indicator
- Water tank capacity 280ml
- Cable length 2m
- With 'smart-wrap' Velcro
- Weight 1.1 Kg
- Dim. H149/L295/D121mm
- 10 units per carton

VIENA 1400~1600W

VIENA 1400~1600W
Ceramic Soleplate
White Grey
REF 8 66 1518 WDG



VIENA 1400~1600W
Ceramic Soleplate
Black
REF 8 66 1518

HIGHLIGHTS

- + Automatic power-off
- + Anti-drip
- + With 'smart-wrap' Velcro

CHARACTERISTICS

- Power: 220~240V, 50/60Hz
- Power range: 1400W - 1600W
- Ceramic soleplate
- Automatic power-off system;
Horizontal position after 30 seconds
Vertical position after 8 minutes
- Dry, steam, spray and burst functions
- Anti-drip
- Self-cleaning function
- Fabric guide indicator
- Water tank capacity 200ml
- Cable length 2m
- With 'smart-wrap' Velcro
- Weight 0.76Kg
- Dim. H125/L250/D106mm
- 12 units per carton

PRESTIGE BOARDS



HIGHLIGHTS

- + Heavy-duty, multi welded construction
- + Luxurious board cover
- + Board cover certified heat resistance to 319°C

CHARACTERISTICS

- Heavy-duty, multi welded construction
- Steel mesh top for good heat flow
- With iron rest
- Automatic locking when folded
- Adjustable height
- Non-slip end caps
- 2 units per carton

BOARD COVER

- Bungee cover with padding sewn together as one-piece, 10mm thick
- Tested for heat resistance (TUV certified)

Model 877552-EB/ 877557-EB

- Folded H1265/W335mm
- Iron surface L970/W330mm

Model 877555-EB

- Folded H1470mm/W335mm
- Iron surface L1160/W330mm



PRESTIGE
Off-White
REF 8 77 552



PRESTIGE
Black
REF 8 77 557

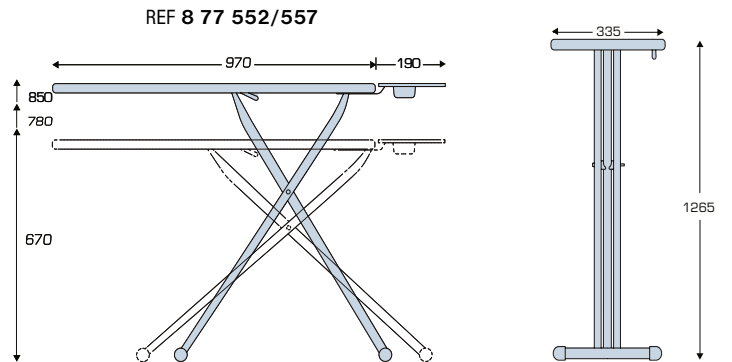

Bungee cover in 1-piece
No strings
Easy to install

PRESTIGE MHK



PRESTIGE
Black
REF 8 77 557-MHK

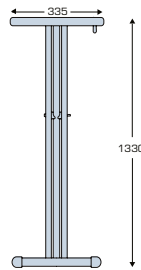
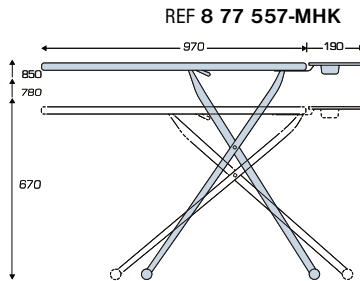

HIGHLIGHTS

- + With foldable hook
- + Double side board covers
- + Board cover heat resistance

CHARACTERISTICS

- Folded H1265/W335mm
- Heavy-duty, steel mesh top
- With iron rest
- Foldable hook (H1330mm extended)
- Automatic locking when folded
- Adjustable height
- Non-slip end caps
- Iron surface 968/330mm
- 10mm bungee cover with padding
- Double side (reversible) black cover
- 2 units per carton

ASCENT BOARD



ASCENT
Black
REF 8 77 633-BK

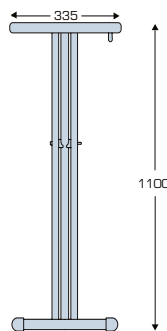
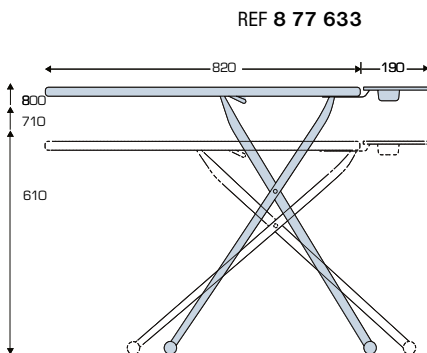

HIGHLIGHTS

- + Space-saving
- + Good ironing height
- + Heavy duty, multi-welded
- + Heat resistant board cover

CHARACTERISTICS

- Folded H1100/W335mm
- Unfolded H800/L1030/W330
- Heavy-duty, steel mesh top
- With iron rest
- Automatic locking when folded
- Adjustable height
- Non-slip end caps
- 10mm bungee cover with padding
- 2 units per carton



The SMARTER CHOICE.



PRESTIGE SWIVEL



PRESTIGE SWIVEL
Black
REF 8 66 1550



Swivel to side for more ironing space



HIGHLIGHTS

- + Space-saving system
- + Combines board with foldable hook, iron holder and board hanger into one
- + Swivel iron rest
- + Heat resistant board cover

CHARACTERISTICS

- Heavy-duty, multi welded construction
- Foldable hanging hook, swivel iron rest
- Steel mesh top for good heat flow
- Automatic locking when folded
- Adjustable height, non-slip end caps
- Folded H1280 x W355 x D180mm
- With hook extended H1330mm
- Iron surface 783/330mm
- 2 units per carton

BOARD COVER

- Bungee cover with padding in one-piece
- Luxurious 10mm thick
- Tested for heat resistance
- Double side (reversible) black cover

IRONGUARD CONNECTION



IRONGUARD Connection
Black
REF 8 66 1124-ICS-MHK



Foldable hanging hook



HIGHLIGHTS

- + Space-saving system
- + Combines board with foldable hook, iron holder and board hanger into one
- + Heat resistance board cover

CHARACTERISTICS

- Heavy-duty, multi welded construction
- Foldable hanging hook
- Steel mesh top for good heat flow
- Automatic locking when folded
- Adjustable height, non-slip end caps
- Folded H1280 x W355 x D180mm
- With hook extended H1330mm
- Iron surface 783/330mm
- 2 units per carton

BOARD COVER

- Bungee cover with padding in one-piece
- Luxurious 10mm thick
- Tested for heat resistance

PRESTIGE DESKTOP



PRESTIGE Desktop
Off-White
REF 8 77 618 DT-NS



PRESTIGE Desktop
Black
REF 8 77 629 DT-NS-BK



HIGHLIGHTS

- + With foldable hook
- + Retractable iron rest
- + Heat resistant board cover
- + Certified for fire resistance up to 319°C

CHARACTERISTICS

- Heavy-duty
- Multi welded construction
- Steel mesh top for good heat flow
- Retractable iron rest
- Non-slip surface
- Folded H850/W300mm
- Height when open 170mm
- Iron surface 800/300mm
- 6 units per carton

BOARD COVER

- Bungee cover with padding sewn together as one-piece, 10mm thick
- Tested for heat resistance

BOARD COVERS



TUV certified
fire-rated



Bungee cover in 1-piece
No strings, Easy to install



Pre-treated for scorch
resistance



Single layer
10mm thick



Double layer
18mm thick



HIGHLIGHTS

- + One-piece bungee + padding
- + No strings, easy and quick to install
- + Fire-rated
- + Luxurious 10mm thick

CHARACTERISTICS

SINGLE-SIDE COVERS

- 888 413 Silver for Armoire 877613
- 888 512 Silver for Prestige 877552
- 888 515 Silver for Prestige 877555
- 888 516 Silver for Prestige 877556
- 888 517 Black for Prestige 877557

DOUBLE-SIDE COVERS

- 888 517-DS Black for Prestige 877557/8661550
- 888 123-DS Silver for Ironguard 8661123
- 888 124-DS Black for Ironguard 8661124

IRON ORGANIZER



HIGHLIGHTS

- + Space-saving system
- + Consists of iron holder & hanger
- + Flexible; board hanger & iron holder installed separately

CHARACTERISTICS

- 18 gauge steel
- Double powder-coated
- Heat resistant buttons
- Adjustable 'wings' hold iron securely
- Handy cord-wrap

Ref: 8 77 001

- For Vinci /Vivo irons
- Size H355/W155/D190mm
- 12 units per carton

Ref: 8 77 005

- For Viena/ Venus/ Vino irons
- Size H320/W125/D160mm
- 24 units per carton



IRON ORGANIZER
Iron Holder + Board hanger
Off-white color
REF 8 77 001/ 8 77 005



IRONGUARD



IRONGUARD
Black
REF 8 66 1117/ 8 66 1519



IRONGUARD
Off-White
REF 8 66 1116/ 8 66 1535



HIGHLIGHTS

- + Space-saving system
- + Consists of iron holder & hanger
- + Flexible; board hanger & iron holder installed separately

CHARACTERISTICS

- Heavy-duty ABS plastic
- Heat-resistant buttons
- Hold iron securely
- Handy cord-wrap
- 12 units per carton

Ref: 866 1116 / 866 1117
- Iron holder and board hanger
- For Vinci/ Vivo irons
- Size H365/W141/D170mm

Ref: 866 1535 / 866 1519
- Iron holder and board hanger
- For Viena / Venus / Vino irons
- Size H325/W125/D150mm

IRON CADDY



IRON Caddy Bag
Beige
REF 8 66 1022



IRON Caddy Bag
Brown (without print)
REF 8 66 1370 BRN



IRON Caddy Bag
Black
REF 8 66 1074

HIGHLIGHTS

- + Handy iron caddy bag
- + Internal heat resistant
- + Heavy-duty zip

CHARACTERISTICS

- Designed to store iron easily & safely
- Cotton on the outside, heat resistant on the inside
- With handy carrier for easy lifting
- Heavy duty zip
- Oversized to fit irons easily
- Size H160/W300/D150mm
- 50 units per carton

MUSE BLUETOOTH SPEAKER CLOCK



REF 8 66 1610



MUSE ALARM CLOCK
Grey
REF 8 66 1610

MUSE ALARM CLOCK
Black
REF 8 66 1610 - BK



ANTI-THEFT DEVICE
BLACK
REF 903 204 - ATL

HIGHLIGHTS

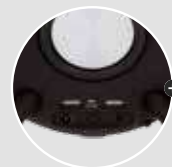

CONVENIENT
Dual USB Mobile
Charging



INTEGRATED
CHARGING CABLES
Apple Lightning
Connector &
Android USB-C
Connector

- + Hotel Mode Single Day Alarm
- + Auto Power Cutover
- + 'Sunrise' Awake
- + High quality Bluetooth Stereo Sound with Bass

CHARACTERISTICS

- Wake up to warm light
- 3 levels of light dimming
- 2 USB charging ports 1.0A
- 2 built-in charging cables
Android and Apple device 1.0A
- Daylight saving feature
- Bluetooth connectivity
- Dual 5W speakers
- Dim. H180/W180/D40mm
- With rechargeable lithium battery
- Adaptor included
- 12 units per carton

HOTEL MODE FEATURES:

- One-off alarm with snooze
- Auto power-cutover
- Optional anti-theft S/S cable

POWER SUPPLY:

To get optimum performance, it is mandatory that device is connected to a dedicated 24/hrs power socket

WAVE BLUETOOTH SPEAKER CLOCK



WAVE ALARM CLOCK
Black
REF 8 66 1691



WAVE ALARM CLOCK
White
REF 8 66 1692



ANTI-THEFT DEVICE
BLACK
REF 903 204 - ATL



HIGHLIGHTS



PRACTICAL
Wireless & USB
charging

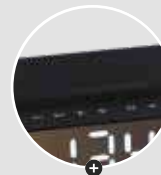

EASY TO USE
Hotel mode
features

- + Hotel Mode Single Day Alarm
- + Auto Power Cutover
- + High quality Bluetooth Stereo Sound with Bass
- + USB & Wireless Mobile Charging

CHARACTERISTICS

- Input 100V-240V, Output 5V, 3A
- Large LCD mirror finish
- 4 levels of light dimming
- 1.0A USB charging port
- 5W wireless charging
- Bluetooth connectivity
- FM radio, AUX, TF card function
- 5W speaker
- Dim. H69/W130/D90mm
- Adaptor included
- Rechargeable lithium battery
- 20 pcs per carton

Optional:
- Anti-theft S/S cable

Power Supply:
To get optimum performance, it is mandatory that device is connected to a dedicated 24/hrs power socket

WALTZ ALARM CLOCK



WALTZ ALARM CLOCK
Black
REF 9 033 18



HIGHLIGHTS

- + 2 mobile charging USB ports
- + Compact with powerful features
- + Hotel Mode Single Day Alarm
- + Auto Power Cutover

CHARACTERISTICS

- Input 100V-240V, Output 5V, 0.3A
- Adjustable screen dimmer
- 2 single day alarm setting
- Snooze function
- 2 USB charging ports 1.0A
- FM radio
- Temperature display
- Dim. H60/W100/D80mm
- Small footprint
- Auto power-cutover
- Adaptor included
- Optional AAA batteries (not included) for auto power cutover
- Ambient temperature reading
- 20 units per carton

To get optimum performance, it is mandatory that device is connected to a dedicated 24/hrs power socket

BEACON



HIGHLIGHTS

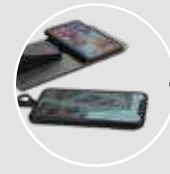

PRACTICAL
+ Wireless & USB charging



LIGHT DIMMER
+ Adjustable lighting



WARM OR WHITE LIGHT

CHARACTERISTICS

- Input: 100V-240V
- Output: 5V/2.4A, 7W
- Adaptor 5V included
- 1.0A USB port for charging
- 5W Wireless charging
- Energy saving 32 LEDs
- Lumens 500LM
- 35,000 hour LED lifespan
- Touch control
- Various lighting options; Cool White/ Warm White/ Warm light
- Brightness control
- Adjustable arm & lamp
- Non-slip base
- Aluminium alloy and ABS
- Weight 1Kg
- Dim. H450/W120/D200mm
- Arm dim. H420mm
- Lamp dim. L380mm
- 12 units per carton



BEACON
White
REF 8 66 1574-WH



BEACON
Silver
REF 8 66 1574 - SIL



USB port and wireless charging

BRILLIANCE



BRILLIANCE
Black/Chrome
REF 8 66 1227



BRILLIANCE
Black
8 66 1227 CBK-RB



BRILLIANCE RC
Black/Chrome
8 66 1227 - RC



BRILLIANCE RC
Black
8 66 1227 -CBK-RB-RC

HIGHLIGHTS

- + JVD proprietary design
- + Smart switch system
- + Drop to cradle design

CHARACTERISTICS

- Specially designed for hotels
- Smart Switch System:
 - Lift torch from cradle to auto on
 - Drop into cradle to auto off
- Powerful 13 LED white light
- Energy-saving LED
- Non-slip handle
- Operates on 3 x AA batteries
- Dim. H190/W50/D60mm
- 20 units per carton

Flashing night light option

- Built-in option
- Load 2 x AAA to activate

Rechargeable option

- Built-in
- Adaptor + rechargeable batteries

PHAROS

PHAROS
Red
REF 8 66 1540



PHAROS
White
REF 8 66 1541



PHAROS
Black
REF 8 66 1539



HIGHLIGHTS

- + Glow in the dark button
- + Smart switch system
- + Drop to cradle design

CHARACTERISTICS

- Specially designed for hotels
- Smart Switch System:
 - Lift torch from cradle to auto on
 - Drop into cradle to auto off
- Strong 6 LED white light
- Energy-saving LED
- Glows in the dark button
- Operates on 3 x AAA batteries
- Dim. H155/W38/D40mm
- 100 units per carton

RADIANCE



RADIANCE
Black
REF 8 66 932



RADIANCE
White
REF 8 66 933

HIGHLIGHTS

- + Smart switch system
- + Flashing night light

CHARACTERISTICS

- Specially designed for hotels
- Smart Switch System:
- Remove torch from bracket to auto on
- Place back to bracket to auto off
- Strong single LED white light
- Energy-saving LED
- With flashing night light
- Operates on 2 x D batteries
- Dim. H210/W60/D50mm
- 48 units per carton

ULTRONIC UV



ULTRONIC UV
Black
REF 8 66 1543

CHARACTERISTICS

- Spots stains on bedsheet & linens
- Aluminium alloy body
- Strong 21 LED UV blue light
- 395 wavelength
- Operates on 3 x AAA batteries
- Dim. H100/W35mm
- 100 units per carton

ZAP II INSECT KILLER



ZAP II
Black
REF 8 66 1699

CHARACTERISTICS

- ABS fire-proof plastic housing
- High quality UV-A lights
- Power 220-240V, 4W
- Grid voltage 800~1000V3/4mA
- Protected area 35m²
- 1 x UV-A lamp, 4W T5/BL
- Indoor use only
- Power cord with plug
- Class II
- Dim. H237/W105mm/D105mm
- 20 units per carton

LUGGAGE RACK



METAL RACK
Black + brown straps
REF 8 66 1530



METAL RACK
Black + black straps
REF 8 66 1530 - BKL

HIGHLIGHTS



4 HIGH-STRENGTH
SYNTHETIC LEATHER
STRAPS

CHARACTERISTICS

- Epoxy steel
- Black finishing
- Foldable
- Floor protection pads
- High-strength PU leather over nylon straps
- Straps in black and brown color
- Folded dim. H612/L515/D45mm
- Unfolded dim. H465/L515/D405mm
- 4 units per carton

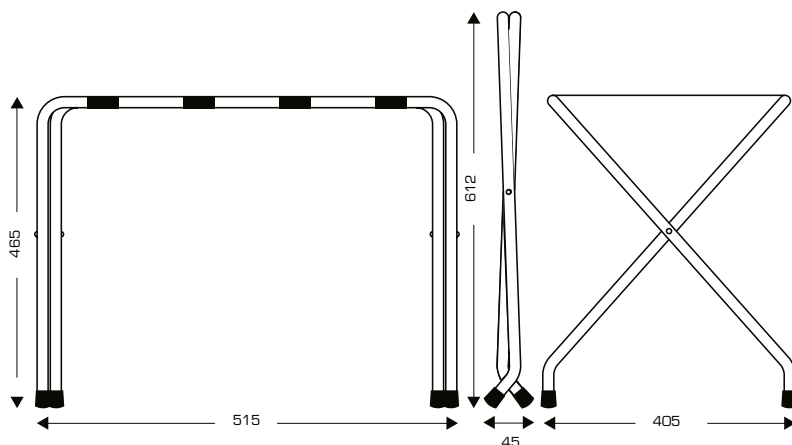

METAL RACK



METAL RACK
CHROME
REF 8 66 069



METAL RACK
Black
REF 8 66 069-BK

CHARACTERISTICS

- Available in 2 finishes; Chrome and Matt Black
- Foldable design
- 4 strengthening straps + 2 supporting PP straps
- Folded dim. H630/L665/D100mm
- Unfolded dim. H500/L665/D400mm
- 1 unit per carton

METAL RACK + BACK BAR



METAL RACK + BACK BAR
CHROME
REF 8 66 506



METAL RACK + BACK BAR
Black
REF 8 66 506-BK

CHARACTERISTICS

- Available in 2 finishes; Chrome and Matt Black
- Foldable design
- With back bar
- 4 strengthening straps + 2 supporting PP straps
- Folded dim. H835/L665/D100mm
- Unfolded dim. H705/L665/D420mm
- 1 unit per carton

PLASTIC RACK



PLASTIC RACK
Black
REF 8 66 1685

CHARACTERISTICS

- Strong PS plastic
- Black with wood grain finish
- Foldable design
- 4 PU faux leather straps
- Folded dim. H740/L505/D120mm
- Unfolded dim. H550/L505/D410mm
- 4 units per carton

ICE BUCKETS



CHARME ICE Bucket
PU Black
REF 8 99 1028



ICE Bucket
S/S Matt
REF 8 99 1536



CHARME ICE Bucket
PU Beige
REF 8 99 1034



CHARME ICE Bucket
PU Black
REF 8 99 1030



CHARACTERISTICS

- Capacity 1 litre
- Internal stainless steel
- Ice tong included

Ref 899 1028

- Single layer
- PU leatherette Black finishing
- Dim. H180/140mm
- 36 units per carton

Ref 899 1536

- Double layer
- Stainless steel finishing
- Dim. H195/150mm
- 12 units per carton

Ref 899 1030

- Double layer
- Include water retainer
- PU leatherette Black finishing
- Dim. H180/150mm
- 12 units per carton

Ref 899 1034

- Double layer
- Include water retainer
- PU leatherette Beige finishing
- Dim. H180/150mm
- 12 units per carton

TISSUE BOX



TISSUE BOX
Black
REF 8 99 960



TISSUE BOX
Ivory
REF 8 99 961



CHARME TISSUE BOX
PU Black
REF 8 99 1035



CHARME TISSUE BOX
PU Black
REF 8 99 1037



CHARME TISSUE BOX
PU Beige
REF 8 99 1038

CHARACTERISTICS

Ref: 899 960/ 961

- High quality melamine material
- Square in black and ivory color
- Dim. H150/L138/D138mm
- 24 units per carton

Ref: 899 1035

- PU leatherette material
- Square in black color
- With magnetic base
- Dim. H150/L130/D130mm
- 36 units per carton

Ref: 899 1037/ 038

- PU leatherette
- Rectangle in black and beige
- With magnetic base
- Dim. H70/L250/D128mm
- 36 units per carton

CAPSULE HOLDER & COASTER



COASTER
PU Black
REF: 8 99 1703



CAPSULE HOLDER
PU Black
Ref: 8 99 1701

HIGHLIGHTS



ELEGANCE
Topstitched seam

+ A timeless design with a leather look

CHARACTERISTICS

Ref: 8 99 1701

- Capsule Holder
- Reversible insert 2 & 4 capsules
- Capsule 20mm Ø
- PU leatherette, Black color
- Dim. H47/L120/D120mm
- 24 units per carton

Ref: 8 99 1703

- Coaster
- Dim. H6mm/100mm Ø
- PU leatherette, Black color
- 200 units per carton

DRAWER TRAY



DRAWER TRAY
PU Black
REF 8 99 1712



CHARACTERISTICS

Ref: 8 99 1712

- Drawer Tray
- 4 compartments
- Main Tray H80/L330/D400mm
- Drawer H47/L320/D380mm
- PU leatherette, Black color
- 8 units per carton

TURNDOWN TRAY



TURNDOWN TRAY
PU Black
REF 8 99 1717



CHARACTERISTICS

Ref: 8 99 1717

- Turndown cum kettle tray
- H55/W400/D300mm
- PU leatherette, Black color
- 12 units per carton

REMOTE CONTROL BINDER



REMOTE CONTROL BINDER
PU Black
REF 8 99 1718

CHARACTERISTICS

Ref: 8 99 1718
- Remote Control Binder
- PU leatherette, Black color
- Dim. H240/L110mm/D50mm
- 60 units per carton

NOTE & DESK PAD



NOTEPAD
PU Black
REF 8 99 1046



DESK PAD
PU Black
REF 8 99 1719

CHARACTERISTICS

REF 8 99 1719
- Desk Pad
- PU leatherette, Black color
- Magnetic fold
- Dim. H12/L500/D405mm
- 20 units per carton

REF 8 99 1046
- Notepad
- PU leatherette, Black color
- Magnetic fold
- Dim. L170/W160mm
- 80 units per carton

DIRECTORY A5



A5 Directory
PU Black
REF 8 99 1715

CHARACTERISTICS

Ref: 8 99 1715
- A5 Directory
- PU leatherette, Black color
- 4 compartments
- 2 ring clamps
- Dim. H245/L170/D40mm
- 40 units per carton

DIRECTORY A4



A4 DIRECTORY
PU Black
REF 8 99 1716

CHARACTERISTICS

Ref: 8 99 1716
- A4 Directory
- PU leatherette, Black color
- 4 compartments
- 3 ring clamps
- Dim. H320/L246/D40mm
- 40 units per carton

OUR SAFE

TRUSTEE PLUS
REF TS PLUS

JVD safes have been synonymous with peace of mind. Your guests have access to a robust and secure storage solution for their belongings.

With JVD Safe Service Unit, managing safes have never been easier and more secure.

**PAGES
58 TO 64**

EVERYTHING YOU NEED TO KNOW TO CHOOSE THE RIGHT SAFE

ILLUMINATED

Our safes are designed with a backlit keypad and interior lighting to make it simple and easy to use.

SECURE

Our safes are fitted with an electronic anti-aggression mechanism & are blocked for 15 minutes after 4 failed attempts.

PRACTICAL

If your guests forget their code, our safes can be unlocked using the electronic Service Unit

SMART

Thanks to the advanced audit trail feature, it is easy to view a history of actions (records of the dates and times when the safe was opened) and to unlock the safe.



A WORD FROM THE DESIGNER

"Fortress safe is created to be effective. To reflect a spirit of tradition and to provide reassurance, a very simple general design was created: a circle in a rectangle, the very symbol of a safe. Thanks to a very refined treatment of the design, the product possesses a very modern, timeless dimension. Two other strengths make the product rather ingenious: the very discreet grip to the left of the front plate and a slightly tilted keypad to improve numbers visibility for users especially when the product is installed at a low height."

Jean-Guy de Russé

FORTRESS



FORTRESS SAFE
BLACK
REF FTS PLUS 195-LPT



Emergency opening
Prolog Service Unit (PSU)

ACCESSORIES



PROLOG
SERVICE UNIT

SMART KEY PIN (SKP-SU)

The SKP is developed by JVD for smaller hotels to manage their daily operations. The SKP is easy and convenient to use and yet secure.

- Easy to use
- No complicated software
- Secure
- Supports safes by providing external battery power



CHARACTERISTICS

- Code locking (4 to 6 digits)
- Power 4x1.5V AA cells
- 20mm diam. dual steel bolts
- Anti-tamper labyrinth
- Inside light & Buzzer
- Lighted LED keypad buttons
- ADA compliant keypad panel
- Non-volatile memory system
- Security lock-out 15 minutes
- Audit trail 200 past events
- Mechanical key override
- Fastening at base and back

Service Unit Options :

- FTS-SKP-SU Smart Key Pin
Performs emergency openings
Provides external power to safe

- PSU Prolog Service Unit

- Performs emergency openings
- Provides external power to safe
- Performs audit trail retrieval

Models :

- **FTS Plus 195-CMP**
Fortress Plus Compact
Dim. H195/W355/D270mm
- **FTS Plus 195-LPT**
Fortress Plus Laptop 14"
Dim. H195/W355/D430mm
- **FTS Plus 200-LPT**
Fortress Plus Laptop 15"
Dim. H200/W420/D370mm
- **FTS Plus 205-LPT**
Fortress Plus Laptop 15"
Dim. H205/W435/D420mm
- **FTS Plus 205-SLPT**
Fortress Plus Superlaptop 17"
Dim. H205/W435/D500mm
- **FTS Plus 195-SLPT**
Fortress Plus Superlaptop 17"
Dim. H195/W435/D500mm

AUDIT TRAIL

It is easy to view a history of events including records of the dates and times when the safe was opened and other details.



TRUSTEE PLUS



TRUSTEE SAFE
BLACK
REF TS PLUS



EMERGENCY OPENING
PROLOG SERVICE UNIT

CHARACTERISTICS

- Code locking (4 to 6 digits)
- Power 4x1.5V AA cells
- 20mm diam. dual steel bolts
- Anti-tamper labyrinth
- Inside light & Buzzer
- Lighted LED keypad buttons
- ADA compliant keypad panel
- Non-volatile memory system
- Security lock-out 15 minutes
- Audit trail 200 past events
- Fastening at base and back

- Mechanical key override
- PSU Prolog Service Unit

Models :

- **TS Plus 195-CMP**
Trustee Plus Compact
Dim. H195/W355/D270mm

- **TS Plus 195-LPT**
Trustee Plus Laptop 14"
Dim. H195/W355/D430mm

- **TS Plus 205-LPT**
Trustee Plus Laptop 15"
Dim. H205/W435/D420mm

- **TS Plus 205-SLPT**
Trustee Plus Superlaptop 17"
Dim. H205/W435/D500mm

ACCESSORIES



PROLOG
SERVICE UNIT

GUARDIAN PLUS



GUARDIAN SAFE
WHITE
REF **GSC PLUS-WH**



CODE & CARD
LOCKING



EMERGENCY OPENING
PROLOG SERVICE UNIT



GUARDIAN FLOOR
BLACK
REF **GSC PLUS-FLR**

CHARACTERISTICS

- Code locking (4 to 6 digits)
- Card locking
- Power 4x1.5V AA cells
- 20mm diam. dual steel bolts
- Anti-tamper labyrinth
- Inside light, Buzzer
- Lighted LED keypad buttons
- ADA compliant keypad panel
- Non-volatile memory system
- Security lock-out 15 minutes
- Audit trail 200 past events
- Fastening at base and back
- Available in Black & White colors

- Mechanical key override
- PSU Prolog Service Unit

GSC Plus 230 LPT

- Guardian Plus Laptop 15"
- Dim. H230/W430/D410mm

GSC Plus-230SLPT

- Guardian Plus Laptop 17"
- Dim. H230/W430/D500mm

GSC Plus 535 Floor

- Guardian Plus Floor
- Dim. H535/W400/D480mm

ICONIC PLUS TOP OPEN



ICONIC TOP OPEN
BLACK
REF **ITO PLUS**



CHARACTERISTICS

- Code locking (4 to 6 digits)
- Power 4x1.5V AA cells
- 20mm diam. dual steel bolts
- Anti-tamper labyrinth
- Inside light & Buzzer
- Lighted LED keypad buttons
- ADA compliant keypad panel
- Non-volatile memory system
- Security lock-out 15 minutes
- Audit trail 200 past events
- Fastening at base and back
- Available in Black & White colors

- Mechanical key override
- PSU Prolog Service Unit

ITO Plus 130

- Iconic Plus Laptop 15"
- Dim. H130/W400/D350mm

ITO Plus 130 SLPT

- Iconic Plus Laptop 17"
- Dim. H130/W460/D350mm

CUSTODIAN



CUSTODIAN SAFE
BLACK
REF CS-200



CHARACTERISTICS

- Code locking (4 to 6 digits)
- Power 4x1.5V AA cells
- 20mm diam. dual steel bolts
- Anti-tamper labyrinth
- Inside light & Buzzer
- Lighted LED keypad buttons
- ADA compliance keypad panel
- Non-volatile memory system
- Security lock-out 15 minutes
- Audit trail 200 past events
- Fastening at base and back
- Mechanical key override
- CSU Service Unit electronic override

CS-200 LPT

- Custodian Laptop 15"
- Dim. H200/W420/D370mm

CUSTODIAN TOP OPEN



CHARACTERISTICS

- Code locking (4 to 6 digits)
- Power 4x1.5V AA cells
- 20mm diam. dual steel bolts
- Anti-tamper labyrinth
- Inside light & Buzzer
- Lighted LED keypad buttons
- ADA compliance keypad panel
- Non-volatile memory system
- Security lock-out 15 minutes
- Audit trail 200 past events
- Fastening at base and back
- Mechanical key override
- CSU Service Unit electronic override

CTO-130

- Custodian Top Open 15"
- Dim. H130/W400/D350mm



CUSTODIAN TOP OPEN
BLACK
REF CTO-130



CUSTODIAN DRAWER



CHARACTERISTICS

- Code locking (4 to 6 digits)
- Power 4x1.5V AA cells
- 20mm diam. dual steel bolts
- Inside light
- Buzzer
- Lighted LED keypad buttons
- ADA compliance keypad panel
- Non-volatile memory system
- Security lock-out 15 minutes
- Audit trail 200 past events
- Fastening at base and back

- Mechanical key override
- CSU Service Unit electronic override

CDS-205 LPT

- Custodian Drawer 15"
- Dim. H205/W475/D370mm



CUSTODIAN DRAWER
BLACK
REF CDS-205 LPT



CSU Service Unit
REF CSU

OUR MINIBARS

JVD minibars are fitted with next-gen smart technologies. Whether they are thermo-absorption, heat-absorption or smart-compressor systems, our minibars are completely silent and reliable.



EVERYTHING YOU NEED TO KNOW TO CHOOSE THE RIGHT MINIBAR

HEAT-ABSORPTION

The conventional heat-absorption minibars generate cold by heating a mixture of gas. The system is highly reliable and completely silent in operation.

SMART COMPRESSOR

Smart compressor minibars come with in-built control panel allows users to make quick cooling when required. It allows for silent cooling when it matters most in the night.

THERMO-ABSORPTION

Next generation thermo-absorption minibars blend the Peltier effect with absorption to generate cold. They are ecological, reliable and completely silent, consuming 66% less energy and therefore quickly offsetting the slightly higher cost (in less than a year).

TOTAL COST PER 100 ROOMS

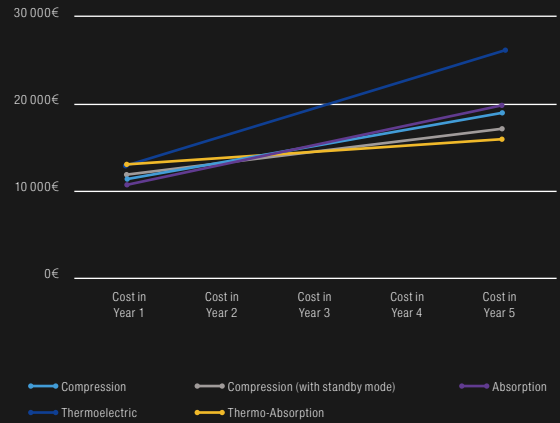

VENTILATION REQUIREMENT

To achieve best cooling performance and optimal lifespan, the minibar needs at least 200cm² free air inlet. This space should be kept constant until the air outlet at the top of the cabinet surface. The rear of the minibar should also be at least 50mm clear from the furniture wall.

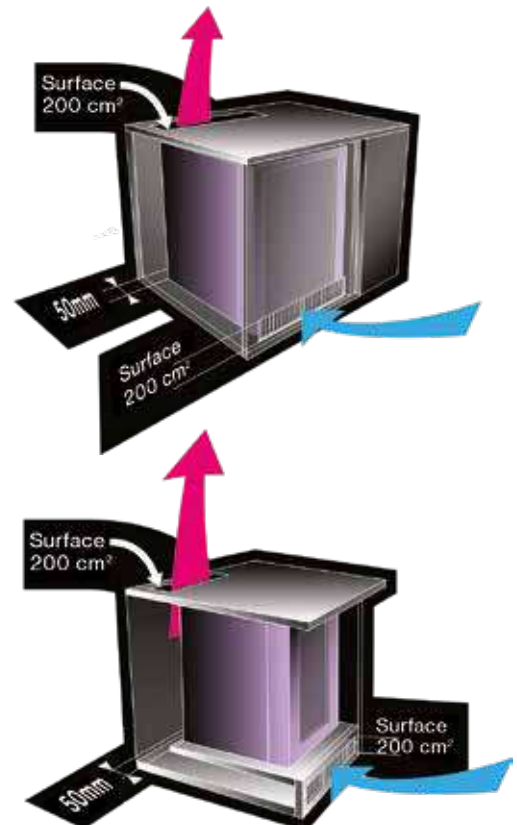



THERMO ABSORPTION 40 L



40 L SOLID DOOR
REF **EC40-BK**



40 L GLASS DOOR
REF **EC40 GD-BK**



CHARACTERISTICS

- Gross capacity 40L
- Dim. H560/W400/D420mm
- Thermo-absorption
- Non-toxic R600A refrigerant
- 100% silent operation

- Power 220V~240V 63W
- Energy consumption 0.278 kWh/24hrs
- Low energy consumption
- Energy Class A+

- Glass door with 3-ply glass panels
- Automatic defrosting
- Interior LED lighting
- Tempered glass shelves 2 nos.
- Quality lock included
- Magnetic door insulation
- Reversible door option
- Black color

THERMO-ABSORPTION 30 L



30 L SOLID DOOR
REF EC 30-BK



30 L GLASS DOOR
REF EC 30 GD-BK



CHARACTERISTICS

- Gross capacity 30L
- Dim. H475/W385/D425mm
- Thermo-absorption
- Non-toxic R600A refrigerant
- 100% silent operation

- Power 220V~240V 63W
- Energy consumption 0.266 kWh/24hrs
- Low energy consumption
- Energy Class A+

- Glass door with 3-ply glass panels
- Automatic defrosting
- Interior LED lighting
- Tempered glass shelf
- Quality lock included
- Magnetic door insulation
- Reversible door option
- Black color

THERMO-ABSORPTION 25 L



25 L SOLID DOOR
REF EC25-BK



25 L GLASS DOOR
REF EC25 GD-BK

CHARACTERISTICS

- Gross capacity 25L
- Dim. H440/W360/D390mm
- Thermo-absorption
- Non-toxic R600A refrigerant
- 100% silent operation

- Power 220V~240V 63W
- Energy consumption 0.285 kWh/24hrs
- Low energy consumption
- Energy Class A+

- Glass door with 3-ply glass panels
- Automatic defrosting
- Interior LED lighting
- Tempered glass shelf
- Quality lock included
- Magnetic door insulation
- Reversible door option
- Black color

HEAT-ABSORPTION 50 L



50 L SOLID DOOR
REF DR50 N-BK



50 L GLASS DOOR
REF DR50 N-GD



CHARACTERISTICS

- Gross capacity 50 litre
- Heat-absorption system
- 100% silent operation
- Automatic defrosting
- Interior LED lighting
- Tempered glass shelves
- Quality lock included
- Magnetic door insulation
- Reversible door option

DR50N Solid Door

- Dim. H570/W455/D480mm
- Power 220V~240V 60W
- Energy consumption. 1.1 kWh/24hrs

DR50N-GD Glass Door

- Dim. H570/W455/D480mm
- 2-ply tempered glass door
- Power 220V~240V 63W
- Energy consumption. 1.4 kWh/24hrs

HEAT-ABSORPTION 60 L



60 L SOLID DOOR
REF FD60 BK



60 L GLASS DOOR
REF FD60-GD

CHARACTERISTICS

- Gross capacity 60 litre
- Heat-absorption system
- 100% silent operation
- Automatic defrosting
- Interior LED lighting
- Tempered glass shelves
- Quality lock included
- Magnetic door insulation
- Reversible door option

FD60 Solid Foam Door

- Dim. H560/W485/D500mm
- Power 220V~240V 85W
- Energy consumption. 1.0 kWh/24hrs

FD60-GD Glass Door

- Dim. H560/W485/D500mm
- 2-ply tempered glass door
- Power 220V~240V 85W
- Energy consumption 1.6 kWh/24hrs

COMPRESSOR 40 L

CHARACTERISTICS

- Gross capacity 40L
- Dim. H552/W405/D440mm
- Compressor
- Low noise compressor system
- Automatic defrosting
- Interior LED lighting
- White coloured steel shelves 2 nos.
- Quality lock included
- Magnetic door insulation
- Reversible door option
- Black color

- Power 220V~240V 85W
- Energy consumption 0.268 kWh/24hrs
- Energy Class A+



40 L SOLID DOOR
REF TAC40 BK



40 L GLASS DOOR
REF TAC 40-GD-FLN-BK



SMART COMPRESSOR 30/ 40 L



HIGHLIGHTS

- ⊕ Quick cooling for new replenishment
- ⊕ Ultra low energy consumption
- ⊕ Highest Class A+++ rating

CHARACTERISTICS

Model : CPE 30

- Gross capacity 30L
- Dim. H505/W402/D425mm

Model : CPE 40

- Gross capacity 40L
- Dim. H565/W402/D485mm

- Smart Compressor system
- Ultra Quiet (programmable)
- Ultra low energy consumption
- Highest Class A+++ rating
- Eutectic cold plate, cold preservation
- Refrigerant R600a, cyclopentane

- Automatic defrosting
- Quality lock included
- Interior LED lighting
- Tempered glass shelves
- Magnetic door insulation
- Reversible door option

Solid Foam Door

- Power: 220-240V, 51W
- Power consumption: 0.145 kWh/24hrs
- Energy Class A+++

Glass Door

- 3-ply tempered glass door
- Power: 220-240V, 51W
- Power consumption: 0.234kWh/24hrs
- Energy Class A+



30 L SOLID DOOR
REF CPE 30-BK



40 L SOLID DOOR
REF CPE 40-BK



30 L GLASS DOOR
REF CPE 30 GD-BK



40 L GLASS DOOR
REF CPE 40 GD-BK

COMPRESSOR DRAWER 50 L



50 L DRAWER MINIBAR
SMART COMPRESSOR
REF **DM-CP50-BK**



CONTENTS

- Bottom rack with adjustable dividers
- Upper deck drawer for miniature bottles

HIGHLIGHTS

- + Quick cooling for new replenishment
- + Ultra low energy consumption
- + Highest Class A+++ rating

CHARACTERISTICS

Model : DM-CP 50

- Gross capacity 50 litre
- Smart Compressor system
- Completely silent (programmable)
- Eutectic cold plate, cold preservation
- Refrigerant R600a, cyclopentane
- Power: 220-240V, 51W
- Power consumption: 0.135 kWh/24hrs
- Ultra low energy consumption
- Highest Class A+++ rating

- Dim. H420/W550/D490mm
- Automatic defrosting
- Interior LED lighting
- Magnetic door insulation

- DM-CP50 (with door handle)
- DM-CP50-NH (no handle; fixation to external cabinetry)

Internal Fittings

- Bottom rack with adjustable dividers
- Upper deck drawer for miniature bottles

HEAT-ABSORPTION DRAWER 50 L



HIGHLIGHTS

- + 100% silent operation
- + Black internal body
- + Internal with wooden drawer

CHARACTERISTICS

- Gross capacity 50 litre
- Heat-absorption system
- Completely silent
- Power: 220-240V, 80W
- Power consumption: 1 kWh/24hrs
- Dim. H430/W550/D500mm
- Automatic defrosting
- Interior LED lighting
- Magnetic door insulation
- DM-HA50 (with door handle)
- DM-HA50-NH (no handle; fixation to external cabinetry)
- Internal Fittings
 - Black body interior
 - Bottom rack with adjustable dividers
 - Upper deck drawer in wood for miniature bottles and wine bottle



50 L Drawer Minibar
HEAT-ABSORPTION
REF DM-HA50-BK



CONTENTS

- Plastic bottom rack
- Adjustable dividers
- Wooden tray on upper deck
- Holds 1 wine bottle and 3 small liquor bottles/candies

THERMO ABSORPTION DRAWER 40 L



40 L DRAWER MINIBAR
THERMO-ABSORPTION
REF DM 40 -BK



HIGHLIGHTS

- + 100% silent operation
- + Low energy consumption

CHARACTERISTICS

- Gross capacity 40 litre
- Thermo-absorption system
- Dim. H412/W495/D455mm
- Refrigerant R600A, cyclopentane
- Automatic defrosting
- Interior LED Lighting
- Magnetic door insulation
- Power 220-240V, 65W
- Low Energy consumption 0.4kWh/24hrs
- Energy class B
- With or without handle

CONTENTS

- Bottom rack with adjustable dividers for bottles and cans
- Drawer tray on upper deck for candy or miniature bottle

MODELS

- DM-40 Stand-alone with Handle
- DM-40-NH No handle - Fixation to external cabinetry

SKY BARS

IT'S ABOUT SPACE & CONVENIENCE

When floor space becomes a constraint, JVD's slim Sky Bars offer the perfect solution. Available in 12L and 17L, these contemporary minibars can be mounted on the wall or by the classic installation within a cabinet.



HIGHLIGHTS

- + 100% silent operation
- + Space saving design
- + Low energy consumption

CHARACTERISTICS

- Thermo-absorption system
- Completely silent
- Refrigerant R600a, cyclopentane
- Power: 220-240V, 65W
- Power consumption: 0.4 kWh/24hrs
- Low energy consumption
- Automatic defrosting
- Interior LED lighting
- Magnetic door insulation

Model : SB 12

- Gross capacity 12 litre
- Dim. H522/W402/D222mm
- Interior black
- SB 12-GD - See-through glass door
- SB 12-BM - Solid door with black tinted glass

Model : SB 17-BM

- Gross capacity 17 litre
- Dim. H435/W410/D305mm
- Interior black
- Solid door with black tinted glass



17 L SKY BAR SOLID DOOR
THERMO-ABSORPTION
REF SB17-BM



12 L SKY BAR GLASS
THERMO-ABSORPTION
REF SB12-GD-BK



12 L SKY BAR
SOLID DOOR
REF SB12-BM

FIESTA GOLD
REF 8 66 1511

OUR MIRRORS

Our mirrors are the result of a special alchemy melding innovation, performance and design. They invite guests to enjoy a unique experience with complete simplicity.

|
**PAGES
76 TO 85**



NO ELECTRICAL CONNECTION REQUIRED

Our Cosmos and Galaxy mirrors run on a lithium battery and a 3 minute auto off system ensuring longevity of 3 to 5 years. Offering complete electrical safety, they can be installed in any volume area of the bathroom

DESIGNED AND MADE IN FRANCE

Concocted by our Design Department specifically for use in hotel bathrooms, our illuminated mirrors are designed in France.

TILTABLE TO ANY ANGLE

Thanks to their double or triple rotational axis, our mirrors offer your guests the best possible reflection.

ECO-RESPONSIBLE

Our illuminated mirrors are fitted with LED lighting to maximize their lifespan without having to change the bulbs and to reduce their energy consumption.

A WORD FROM THE DESIGNER

"Mirrors invite us to enter a new dimension.

The magnifying function of a mirror allows us to enter into a universe where everything is bigger. I wanted this voyage to take us even further, so I drew inspiration from flying saucers in designing this mirror. I added a revolutionary battery operated «motor», unique on the market.

I structured the whole thing around a chrome base, to which I added a ring of light like the ones around Saturn. And lastly, I added an almost magical capacitive switch."

Jean-Guy de Russé

COSMOS



COSMOS
Brass, Chrome
REF 8 66 1136



COSMOS
Brass, Matt-Black
REF 8 66 1136-BK

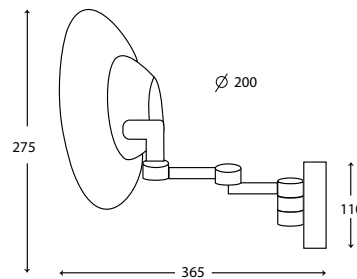

HIGHLIGHTS



LED lighting all round the mirror



Magnifying reflection x5



No electrical connection required

CHARACTERISTICS

- LED lighting all round the mirror
- Cool white LED light 6000K
- Mirror size 200mm
- Magnification 5X
- Touch activation
- Battery life up to 3 years
- Works on 3.6V lithium battery
- 3 minutes auto-off
- Excellent rust resistance
- 12 units per carton

Ref: 8 66 1136

- Wall-mounted, double arm
- Brass in Chrome finishing

Ref: 8 66 1136-BK

- Wall-mounted, double arm
- Brass in Matt-Black finishing

Ref: 8 66 1136-DT

- Desktop, adjustable height
- Brass in Chrome finishing

Ref: 8 66 1136-BK-DT

- Desktop, adjustable height
- Brass in Matt-Black finishing



COSMOS desktop
Brass, Matt-Black
REF 8 66 1136-BK-DT



COSMOS desktop
Brass, Chrome
REF 8 66 1136-DT

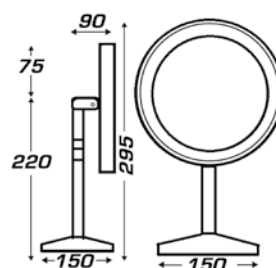

GALAXY



GALAXY
Brass, Chrome
REF 8 66 769



GALAXY
Brass, Chrome
REF 8 66 920

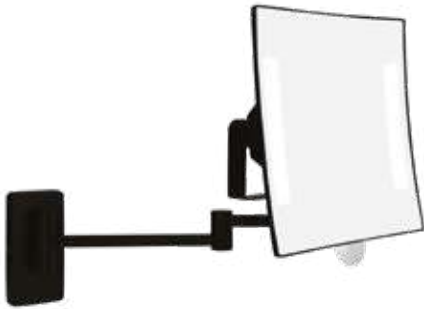

GALAXY
Brass, Matt-Black
REF 8 66 769-BK



GALAXY desktop
Brass, Matt-Black
REF 8 66 920-BK

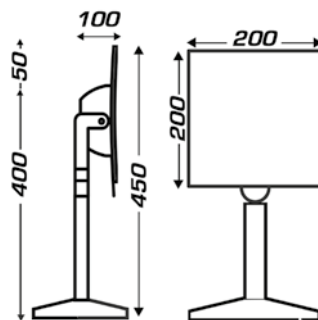
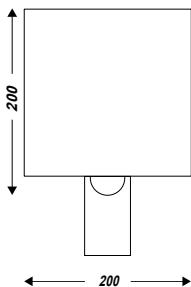
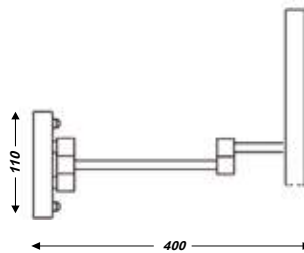

HIGHLIGHTS

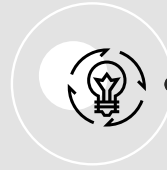

+ Double LED lighting



+ Magnifying reflection x3



+ No electrical connection required

CHARACTERISTICS

- Double LED lighting
- Cool white LED light 6000K
- Mirror size 200mm
- Magnification 3X
- Touch activation
- Battery life up to 3 years
- Works on 3.6V lithium battery
- 3 minutes auto-off
- Brass in chrome or matt black
- Excellent rust resistance
- 12 units per carton

Ref: 8 66 769

- Wall-mounted, double arm
- Brass in Chrome finishing

Ref: 8 66 769-BK

- Wall-mounted, double arm
- Brass in Matt-Black finishing

Ref: 8 66 920

- Desktop, adjustable height
- Brass in Chrome finishing

Ref: 8 66 920-BK

- Desktop, adjustable height
- Brass in Matt-Black finishing

LUNAIRE



LUNAIRE
Brass, Chrome
REF 8 66 311

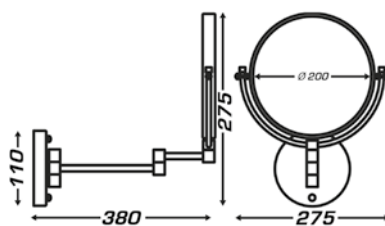

CHARACTERISTICS

- AC, 220V ~ 240V, 18V
- Mirror single side, 200mm
- Magnification 3X
- Cool white LED light 6000K
- Wall-mounted, double arm
- Brass in chrome finishing
- Excellent rust resistance
- 10 units per carton

LUNAIRE XL EVO



LUNAIRE XL Evo
Brass, Chrome
REF 8 66 1267



LUNAIRE DUET Evo
Brass, Chrome
REF 8 66 1268

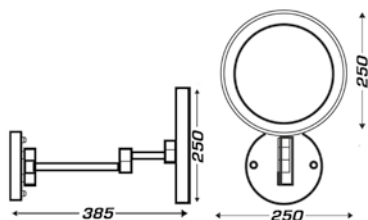

CHARACTERISTICS

- AC, 220V ~ 240V, 18V
- Mirror single side, 250mm
- Magnification 5X
- Touch activation
- Manual power off/ 15 min. auto-off
- Wall-mounted, double arm
- Brass in chrome finishing
- Excellent rust resistance
- 10 units per carton

Ref: 8 66 1267

- Cool White light 6000K

Ref: 8 66 1268

- Cool white 6000K + Warm 3000K
(Touch to switch between white and warm light)

CELESTE



CELESTE ILLUMINATED ROUND
Tubular chrome brass arm
REF 8 66 1651

HIGHLIGHTS



PRACTICAL
SmarTech® blue
touch sensor



TWO LIGHTING OPTIONS:
warm or cold
white light

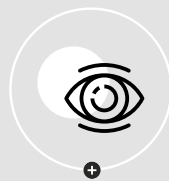

MAGNIFYING REFLECTION
X3

CHARACTERISTICS

- 220-240 V
- Mirror diameter: 230 mm
- Wall-mounted double arm
- Magnifying reflection x3
- LED lighting
- Warm or cold white light
- Manual off switch or auto off after 15 minutes
- Brass (rust resistant)
- Finish: Chrome

CELESTE



CELESTE
Brass, Chrome
REF 8 66 1649



CELESTE Duet
Brass, Chrome
REF 8 66 1651

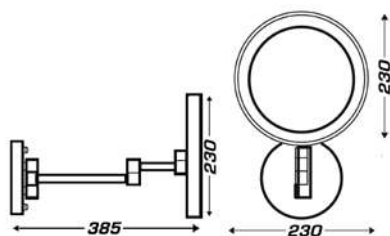

CHARACTERISTICS

- AC, 220V~240V, 18V
- Mirror single side, 230mm
- Magnification 3X
- Touch activation
- Manual power off/ 15 min. auto-off
- Brass in chrome finishing
- 10 units per carton

Ref: 8 66 1649

- Wall-mounted, double arm
- Cool White light 6000K

Ref: 8 66 1651

- Wall-mounted, - Double arm
- Cool white 6000K + Warm 3000K
(Touch to switch between white and warm light)

CELESTE DESKTOP



CELESTE desktop
Brass, Chrome
REF 8 66 1650



CELESTE DUET DESKTOP
BRASS, CHROME
REF 8 66 1652



CHARACTERISTICS

- AC, 220V~240V, 18V
- Mirror single side, 230mm
- Magnification 3X
- Touch activation
- Manual power off/ 15 min. auto-off
- Brass in chrome finishing
- 10 units per carton

Ref: 8 66 1650

- Desktop, Cool White light 6000K

Ref: 8 66 1652

- Desktop, Cool White 6000K + Warm 3000K
(Touch to switch between white and warm light)

POLARIS



REF 8 66 1653



POLARIS
Brass, Chrome
REF 8 66 1653



POLARIS DESKTOP
Brass, Chrome
REF 8 66 1654

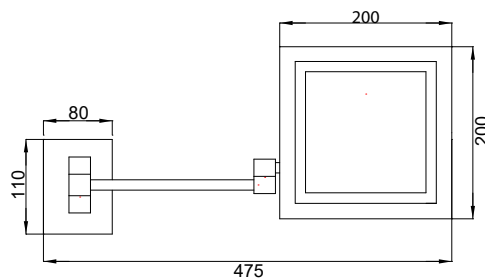
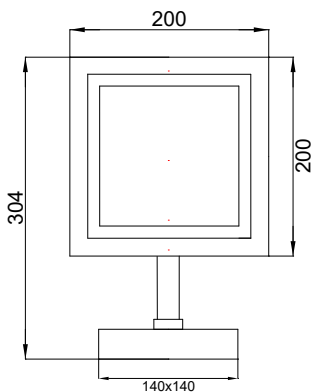

HIGHLIGHTS

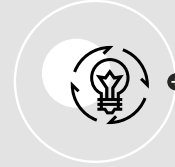

+ LED lighting all round the mirror



+ Magnifying reflection x3

CHARACTERISTICS

- AC, 220V~240V, 18V
- Mirror single side, 200mm
- Magnification 3X
- Touch activation
- Manual power off/ 15 min. auto-off
- Brass in chrome finishing
- Excellent rust resistance
- 10 units per carton

Ref: 8 66 1653

- Wall-mounted, double arm
- Cool White light 6000K

Ref: 8 66 1654

- Desktop
- Cool White light 6000K

FIESTA WALL-MOUNTED



Fiesta Mirror
 With its two sides (1x and 3x magnification), the Fiesta Mirror and its elegant tubular chrome brass arm elegantly take beauty to the next level, with a simple movement of the hand.

HIGHLIGHTS

- + Double sided mirror (normal and 3X)
- + Choice of 4 finishes
- + Tubular chrome brass arm
- + Excellent rust resistance

CHARACTERISTICS

- Wall-mounted
- Double arm
- Double side mirror :
 - One side normal
 - One size 3X magnification
- Mirror single size, 200mm
- Brass arm with SS304 bracket
- Excellent rust resistance
- 12 units per carton

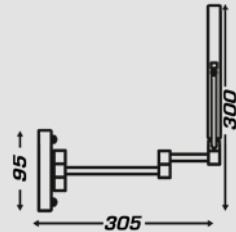
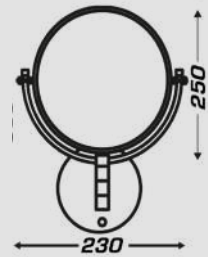

FIESTA
 Brass, Chrome
REF 8 66 1510



FIESTA
 Brass, Gold Chrome
REF 8 66 1511



FIESTA
 Brass, Rose Gold
REF 8 66 1512

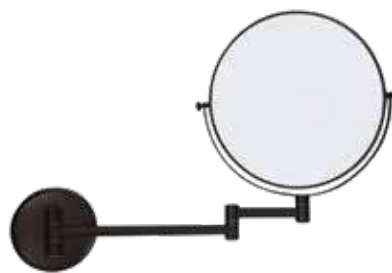

FIESTA
 Brass, Matt Black
REF 8 66 1687

FIESTA DESKTOP



FIESTA DESKTOP
Brass, Chrome
REF 8 66 1514



FIESTA DESKTOP
Brass, Gold Chrome
REF 8 66 1515



FIESTA DESKTOP
Brass, Rose Gold
REF 8 66 1516



FIESTA DESKTOP
Brass, Matt Black
REF 8 66 1688

HIGHLIGHTS

- + Double sided mirror (normal and magnification x3)
- + Choice of 4 finishes
- + Tubular chrome brass arm

CHARACTERISTICS

- Desktop
- Double side mirror
- Normal and 3X
- Mirror 200mm Ø
- Brass
- Excellent rust resistance
- 12 units per carton

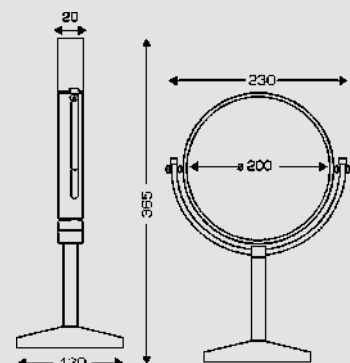



Explore our full range of bathroom accessories. Between our scales, amenity trays, bins and others. Put the finishing touches on your bathrooms with some of our many hotel accessories



DIGITAL SCALES

CONSTAZ DIGITAL



CONSTANZ DIGITAL
Transparent
REF 8 66 2116

CHARACTERISTICS

- Dim. H23/330mm
- KG/LB selector
- LCD display
- 6mm tempered glass
- Capacity 180KG/396 LB
- Operates on 1 lithium battery
- Transparent with black
- 5 units per carton

TRANQUIL DIGITAL



TRANQUIL DIGITAL
Transparent
REF 8 66 2117

CHARACTERISTICS

- Dim. H25/302/302mm
- KG/LB selector
- LCD display
- 6mm tempered glass
- Capacity 180KG/396 LB
- Operates on 2x1.5V AAA
- Silver color
- 5 units per carton

ECLAT II DIGITAL



ECLAT II DIGITAL
Light Green
REF 8 66 754

CHARACTERISTICS

- Dim. H24/310/300mm
- KG/LB selector
- LCD display
- Lighted digits
- 6mm tempered glass
- Capacity 180 Kg/396 LB
- Operates on 3AAA batteries
- 5 units per carton

ECLAT II DIGITAL



ECLAT II DIGITAL
Black
REF 8 66 753

CHARACTERISTICS

- Dim. H24/310/300mm
- KG/LB selector
- LCD display
- Lighted digits
- 6mm tempered glass
- Capacity 180 Kg/396 LB
- Operates on 3AAA batteries
- 5 units per carton

ENVIE DIGITAL



ENVIE DIGITAL
Truffle Black
REF 8 66 1525

CHARACTERISTICS

- Slim H16/275/275mm
- Non-slip platform
- 5mm thick
- KG/LB selector
- LCD display
- Capacity 180KG/396 LB
- Operates on 1 lithium battery
- Truffle Black
- 8 units per carton

ENVIE DIGITAL



ENVIE DIGITAL
Pepper White
REF 8 66 1526

CHARACTERISTICS

- Slim H16/275/275mm
- Non-slip platform
- 5mm thick
- KG/LB selector
- LCD display
- Capacity 180KG/396 LB
- Operates on 1 lithium battery
- Pepper White
- 8 units per carton

DIGITAL SCALES

ELAN SS DIGITAL



ELAN SS DIGITAL
Brushed Stainless Steel
REF 8 66 1151-V1

CHARACTERISTICS

- Dim. H25/302/302mm
- 5mm tempered glass
- KG/LB selector
- LCD display
- With backlight
- Capacity 180Kg/ 396LB
- Operates on 1 lithium battery
- Brushed S/S platform
- 5 units per carton

ELAN CLASSIC



ELAN CLASSIC ALT-DIGITAL
Silver
REF 8 66 1146-V1

CHARACTERISTICS

- Dim. H25/300/260 mm
- Alternate KG/LB display
- LCD display
- With backlight
- 6mm tempered glass
- Capacity 180KG/396 LB
- Operates on 2 AAA batteries
- Silver color
- 6 units per carton

ELAN DELUXE



ELAN DELUXE ALT-DIGITAL
Silver
REF 8 66 1149-V1

CHARACTERISTICS

- Dim. H25/310/310 mm
- Alternate KG/LB display
- LCD display
- With backlight
- 6mm tempered glass
- Capacity 180KG/396 LB
- Operates on 3 x AAA batteries
- Silver color
- 5 units per carton

ELAN DELUXE



ELAN DELUXE ALT-DIGITAL
Champagne
REF 8 66 1150

CHARACTERISTICS

- Dim. H20/310/310 mm
- Alternate KG/LB display
- LCD display
- With backlight
- 6mm tempered glass
- Capacity 180KG/396 LB
- Operates on 4 AAA batteries
- Champagne color
- 5 units per carton

DYNA | **ECO**DESIGN



DYNA DIGITAL
Black
REF 8 66 1527



INNOVATION
Recharges by simply stepping on the button once

CHARACTERISTICS

- Dim. H25/300/300 mm
- KG/LB selector
- LCD display
- Reinforced tempered glass
- 5mm thick
- Capacity 180KG/396 LB
- Battery-free system
- Available in Black and White
- 5 units per carton



DYNA DIGITAL
Black
REF 8 66 1563



BATTERY-FREE
One simple step
Generate power
Precision

RECYCLE BIN 10L



RECYCLE BIN 10 L
Metal, Black
Ref 8 99 1229-ML-RCL



CHARME RECYCLE BIN 10 L
PU, Black
REF 8 99 1229 PLUS BK

CHARACTERISTICS

- Round, 10 litre
- Dim. H270/W225mm
- Outer bin in steel
- With anti-slip rubber base
- Includes 2 inner plastic bins
- 6 units per carton

Ref: 8 99 1229-ML-RCL
- Powder-coated Black color

Ref: 8 99 1229-PLUS-BK
- PU leatherette, Black color

RECYCLE BIN 14L



RECYCLE BIN 14 L
Metal, Black
REF 8 99 1261-ML-RCL



CHARME RECYCLE BIN 14 L
PU, Black
REF 8 99 1261-PLUS-BK

CHARACTERISTICS

- Rectangle, 14 litre
- H296/L270/D210mm
- Outer bin in steel
- Includes 2 inner plastic bins
- 6 units per carton

Ref: 8 99 1261-ML-RCL
- Powder-coated Black color

Ref: 8 99 1261-PLUS-BK
- PU leatherette, Black color

RECYCLE BIN 20L



RECYCLE BIN 20 L
Metal, Black
REF 8 99 1648 BK-RCL



CHARACTERISTICS

- Rectangle, 20 litre
- H310/L344/D231mm
- Outer bin in steel
- Includes 2 inner Fire Retardant PP Bins
- Powder-coated, Black color
- 6 units per carton

PEDAL BINS



PEDAL Bin, 5L
S/S Matt,
REF **WBE- 3 00 331**



PEDAL Bin, 3L
S/S Matt Black
REF **WBF- 3 00 332-MB**

PEDAL Bin, 5L
S/S Matt Black
REF **WBF- 3 00 333-MB**

PEDAL Bin, 12L
S/S Matt Black
REF **WBF- 3 00 335-MB**



PEDAL Bin, 3L
S/S Matt
REF **WBF-3 00332**

PEDAL Bin, 5L
S/S Matt
REF **WBF- 3 00 333**

PEDAL Bin, 12L
S/S Matt
REF **WBF- 3 00 335**

SINGLE LAYER BINS



METAL Bin, 10L
PU Straw Mat
REF **WB- 3 00 326**



PLASTIC Bin, 13.2L
Black
REF **WB- 3 00 316**



PLASTIC Bin, 10L
Black
REF **WBU- 3 00 526**



PLASTIC Bin, 10L
Beige
REF **WBF- 3 00 527**

HIGHLIGHTS

- + Soft-close lid
- + Anti-slip rubber base
- + Plastic liner included

CHARACTERISTICS

Ref: **WBF-300 331**

- 5 litre, H290/W205mm
- Anti-fingerprint
- S/S Matt finishing
- 6 units per carton

Ref: **WBF-300 332/ 332-MB**

- 3 litre, H262/W171mm
- S/S Matt/ Matt Black
- 6 units per carton

Ref: **WBF-300 333/ 333-MB**

- 5 litre, H280/W205mm
- S/S Matt/ Matt Black
- 6 units per carton

Ref: **WBF-300 335/ 335-MB**

- 12 litre, H395/W252mm
- S/S Matt/ Matt Black
- 4 units per carton

CHARACTERISTICS

Ref: **WB-300 326**

- 10 litre, H255/W230mm
- Single layer metal bin
- PU Straw Mat finishing
- 6 units per carton

Ref: **WB-3 00 316**

- 13.2 litre, H310/W210/D290mm
- Durable, impact and rust resistant
- Black color
- 20 units per carton

Ref: **WBU-300 526/ 527**

- 10 litre, H285/W235/D155mm
- With PVC wrap-around
- Durable, impact and rust resistant
- Black & Beige color
- 6 units per carton

SWING TOP BINS



SWING TOP, 8L
Stainless Steel Finish
REF **WBU- 3 00 513**



SWING TOP, 8L
Black
REF **WBU- 3 00 514**

CHARACTERISTICS

- Single layer, metal
- Swing top-lid
- 8 litre, H260/W200mm
- Anti-slip rubber lining at base
- 6 units per carton

Ref: **WBU-300 513**

- Stainless steel finishing

Ref: **WBU-300 514**

- Powder coated in Black



SWING TOP BIN 10L
Beige
REF **WBS-3 00 580**

CHARACTERISTICS

- Ref: **WBS-300 580**
- 10 litre, H410/W177/D270mm
- Single layer strong PP plastic
- With swing top lid
- Beige color
- 12 units per carton

FR BINS



FR BIN, 10L
Black
REF **WBR- 3 00 537**



FR BIN, 10L
Black
REF **WBR- 3 00 539**

CHARACTERISTICS

- FR bins
- 10 litre capacity
- Plastic, fire-rated material
- Black color
- 6 units per carton

Ref: **WBR-300 537**

- Anti-slip rubber lining at base
- H270/W225mm

Ref: **WBR-300 539**

- 10L, H300/W228/D175mm



DOUBLE LAYER FR Bin
10L, Rose Copper
REF **WBR-3 00 564**

CHARACTERISTICS

- Ref: **WBR- 300 564**
- Round double-layer
- 10L, H270/W225mm
- Outer in S/S, inner FR plastic liner
- Anti-slip rubber lining at base
- Polish S/S Rose Copper Finish
- 6 units per carton

PP DOUBLE LAYER 8 L



PLASTIC DOUBLE LAYER
8 L, Matt Black
REF **WBU-3 00 568-MB**



Plastic DOUBLE Layer Bin
8 L, Grey
REF **WBU-3 00 568-GRY**



PLASTIC DOUBLE LAYER
8 L, White
REF **WBU-3 00 568-WH**



Brown plastic liner
included

CHARACTERISTICS

- Round double-layer
- 8 litre, H257/W215/D195mm
- Outer PP plastic
- Inner plastic liner in brown color
- 12 units per carton

Ref: WBM-300 568-WH
- White color

Ref: WBM-300 568-GRY
- Grey color

Ref: WBM-300 568-MB
- Matt Black color

ROUND METAL DOUBLE LAYER 10 L



ROUND DOUBLE LAYER
10 L, Black
REF **WBU-3 00 516**



DOUBLE LAYER
10 L, PU Black
REF **WBU-3 00 515**



ROUND DOUBLE LAYER
10 L, Brown
REF **WBU-3 00 518**

CHARACTERISTICS

- Round double layer
- 10 litre, H270/W225
- Outer metal, inner metal liner
- With anti-slip rubber base
- 6 units per carton

Ref: **WBU-300 516**
- Powder-coated, Black color

Ref: **WBU-300 515**
- PU leatherette, Black color

Ref: **WBU-300 518**
- PU leatherette, Brown color

OVAL METAL DOUBLE LAYER 10 L



OVAL DOUBLE LAYER
10 L, Black
REF **WBU-3 00 520**



OVAL DOUBLE LAYER
10 L, Beige
REF **WBU-3 00 521**



OVAL DOUBLE LAYER
10 L, PU Brown
REF **WBU-3 00 522**



OVAL DOUBLE LAYER,
10 L, PU Black
REF **WBU-3 00 519**

CHARACTERISTICS

- Oval double-layer
- 10 litre, H270/L260/D190mm
- Outer metal, inner metal liner
- With anti-slip rubber base
- 6 units per carton

Ref: **WBU-300 520**
- Powder-coated, Black

Ref: **WBU-300 521**
- Powder-coated, Beige

Ref: **WBU-300 519**
- PU leatherette, Black

Ref: **WBU-300 522**
- PU leatherette, Brown

RECT. METAL DOUBLE LAYER 7.6 L



RECT. DOUBLE LAYER
7.6 L, Black
REF **WBU-3 00 523**



RECT. DOUBLE LAYER
7.6 L, Black
REF **WBU-3 00 523-MBR**

CHARACTERISTICS

- Rectangle double-layer
- 7.6 litre, H275/L225/D165mm
- Outer metal, inner metal liner
- With anti-slip rubber base
- 6 units per carton

Ref: **WBU-300 523**
- Powder-coated, Black
- Chrome top rim

Ref: **WBU-300 523-MBR**
- Powder-coated, Black
- Black top rim

FRUSTUM METAL DOUBLE LAYER 10 L

FRUSTRUM DOUBLE LAYER
10 L, Black
REF **8 99 1039**



FRUSTRUM DOUBLE LAYER
10 L, Beige
REF **8 99 1040**

CHARACTERISTICS

- Frustrum double-layer
- 10 litre, H340/L140mm
- Outer metal with PU
- Inner metal liner in Black
- With anti-slip rubber base
- 6 units per carton

Ref: **8 99 1039**
- PU leatherette, Black

Ref: **8 99 1040**
- PU leatherette, Beige



FIESTA DESKTOP
REF 8 66 1688

RUSTIC TRAY
REF RBWG 3 00 731

HIGHLIGHTS

- + High quality resin
- + Brown Wood Grain finishing
- + Water and rust resistant

CHARACTERISTICS

Ref: RBWG-300731
- Rustic Amenity Tray
- Dim. H30/L350/D250mm

Ref: RBWG-300732
- Rustic Tissue Box
- Magnetic base cover
- Dim. H150/L140/D140mm

Ref: RBWG-300733
- Rustic Soap Dish
- Dim. H15/L100/D100mm

RUSTIC COLLECTION



RUSTIC TISSUE BOX
REF RBWG-3 00 732
UPC 8



RUSTIC AMENITY TRAY
REF RBWG-3 00 731
UPC 10



RUSTIC SOAP DISH
REF RBWG-3 00 733
UPC 40

GUILIN COLLECTION



GUILIN AMENITY DRAWER
REF **RBS-3 00 724**
UPC 4



GUILIN AMENITY TRAY
REF **RBS-3 00 721**
UPC 10



GUILIN SOAP DISH
REF **RBS-3 00 723**
UPC 40



GUILIN TISSUE BOX
REF **RBS-3 00 722**
UPC 8

HIGHLIGHTS

- + High quality resin
- + Bamboo style
- + Water and rust resistant

CHARACTERISTICS

Ref: RBS-300721
- Guilin Amenity Tray
- Dim. H20/L310/D130mm

Ref: RBS-300722
- Guilin Tissue Box
- Magnetic base cover
- Dim. H150/L140/D140mm

Ref: RBS-300723
- Guilin Soap Dish
- Dim. H25/L113/D113mm

Ref: RBS-300724
- Guilin Amenity Drawer Box
- 3 compartments
- Dim. H90/L275/D155mm

TERRAZZO COLLECTION



TERRAZZO TISSUE BOX
REF **RTE-3 00 791**
UPC 8



TERRAZZO SOAP DISH
REF **RTE-3 00 792**
UPC 40



TERRAZZO AMENITY TRAY
REF **RTE-3 00 790**
UPC 10

HIGHLIGHTS

- + High quality resin
- + Colored stones finishing
- + Water and rust resistant

CHARACTERISTICS

Ref: RTE-300790
- Terrazzo Amenity Tray
- Dim. H20/L310/D130mm

Ref: RTE-300791
- Terrazzo Tissue Box
- Magnetic base cover
- Dim. H150/L140/D140mm

Ref: RTE-300792
- Terrazzo Soap Dish
- Dim. H20/D95mm

CARRARA COLLECTION



CARRARA AMENITY DRAWER
REF **RWM-3 00 706**
UPC 4



CARRARA AMENITY TRAY
REF **RWM-3 00 701**
UPC 10



CARRARA SOAP DISPENSER
REF **RWM-3 00 704-RD**
UPC 40



CARRARA CONDIMENT HOLDER
REF **RWM-3 00 705**
UPC 40



CARRARA SOAP DISPENSER
REF **RWM-3 00 704**
UPC 40



CARRARA TISSUE BOX
REF **RWM-3 00 702**
UPC 8



CARRARA SOAP DISH
REF **RWM-3 00 703**
UPC 40

HIGHLIGHTS

- + High quality resin
- + White marble finishing
- + Water and rust resistant

CHARACTERISTICS

Ref: RWM-300701
- Carrara Amenity Tray
- Dim. H20/L310/D130mm

Ref: RWM-300702
- Carrara Tissue Box
- Magnetic base cover
- Dim. H150/L140/D140mm

Ref: RWM-300703
- Carrara Soap Dish
- Dim. H22/L117/D83mm

Ref: RWM-300704/ 04-RD
- Carrara Soap Dispenser
- Plastic silver pump
- Dim. H180/L65/D65mm

Ref: RWM-300705
- Carrara Condiment Holder
- Dim. H105/W80mm

Ref: RWM-300706
- Carrara Amenity Drawer Box
- Dim. H90/L275/D155mm

MOMI COLLECTION



MOMI SOAP DISH
REF **RSR-3 00 783**
UPC 40



MOMI AMENITY TRAY
REF **RSR-3 00 781**
UPC 10



MOMI TISSUE BOX
REF **RSR-3 00 782**
UPC 8

HIGHLIGHTS

- + High quality resin
- + Shagreen finishing
- + Water and rust resistant

CHARACTERISTICS

Ref: RSR-300781
- Momi Amenity Tray
- Dim. H40/L240/D240mm

Ref: RSR-300782
- Momi Tissue Box
- Magnetic base cover
- Dim. H150/L140/D140mm

Ref: RSR-300783
- Momi Soap Dish
- Dim. H20/L105/D80mm

SPACE COLLECTION



SPACE SOAP DISH
REF **RWO-3 00 753**
UPC 40



SPACE TISSUE BOX
REF **RWO-3 00 754**
UPC 8



SPACE AMENITY TRAY
REF **RWO-3 00 751**
UPC 10



SPACE SQUARE TRAY
REF **RWO-3 00 752**
UPC 10

HIGHLIGHTS

- + High quality resin
- + White-oak wash finishing
- + Water and rust resistant

CHARACTERISTICS

Ref: RWO-300751
- Space Amenity Tray
- Dim. H20/L310/D120mm

Ref: RWO-300752
- Space Square Amenity Tray
- Dim. H40/L240/D240mm

Ref: RWO-300753
- Space Soap Dish
- Dim. H20/1100mm

Ref: RWO-300754
- Space Tissue Box
- Magnetic base cover
- Dim. H150/L140/D140mm

ROYALE COLLECTION



ROYALE SQUARE TRAY
REF **RBF-3 007 62**
UPC 10



ROYALE AMENITY TRAY
REF **RBF-3 00 761**
UPC 10



ROYALE CONDIMENT HOLDER
REF **RBF-3 00 765**
UPC 40



HIGHLIGHTS

- + High quality resin
- + Brass paint finishing
- + Water and rust resistant

CHARACTERISTICS

Ref: RBF-300761
- Royale Amenity Tray
- Dim. H20/L310/D120mm

Ref: RBF-300762
- Royale Square Amenity Tray
- Dim. H40/L240/D240mm

Ref: RBF-300763
- Royale Soap Dish
- Dim. H20/110mm

Ref: RBF-300764
- Royale Tissue Box
- Magnetic base cover
- Dim. H150/L140/D140mm

Ref: RBF-300765
- Royale Condiment Holder
- Dim. H90/L140/D100mm



ROYALE TISSUE BOX
REF **RBF-3 00 764**
UPC 8



ROYALE SOAP DISH
REF **RBF-3 00 763**
UPC 40

GOTHIC COLLECTION



GOTHIC SOAP DISH
REF **RMB-3 00 713**
UPC 40



GOTHIC AMENITY TRAY
REF **RMB-3 00 711**
UPC 10

GOTHIC TISSUE BOX
REF **RMB-3 00 712**
UPC 8



GOTHIC SOAP DISPENSER
REF **RMB-3 00 714**
UPC 40

GOTHIC AMENITY DRAWER
REF **RMB-3 00 716**
UPC 4



GOTHIC CONDIMENT HOLDER
REF **RMB-3 00 715**
UPC 40

HIGHLIGHTS

- + High quality resin material
- + Matt black finishing
- + Water and rust resistant

CHARACTERISTICS

Ref: RMB-300711
- Gothic Amenity Tray
- Dim. H20/L310/D130mm

Ref: RMB-300712
- Gothic Tissue Box
- Magnetic base cover
- Dim. H150/L140/D140mm

Ref: RMB-300713
- Gothic Soap Dish
- Dim. H22/L117/D83mm

Ref: RMB-300714
- Gothic Soap Dispenser
- Plastic silver pump
- Dim. H180/L65/D65mm

Ref: RMB-300715
- Gothic Condiment Holder
- Dim. H105/L80/D80mm

Ref: RMB-300716
- Gothic Amenity Drawer Box
- 3 compartments
- Dim. H90/L275/D155mm

PALETTE AMENITY TRAY



PALETTE AMENITY TRAY
Black
REF 8 66 1697



CHARACTERISTICS

- High quality melamine
- Unique tapered design
- Anti-slip footing
- 5 compartments
- Polish Black finishing
- Dim. H25/L360/W230mm
- 20 units per carton

ZEN LINE AMENITY TRAY



ZEN LINE AMENITY TRAY
White
REF 8 66 887



ZEN LINE AMENITY TRAY
Black
REF 8 66 893



ZEN LINE AMENITY TRAY
Ivory
REF 8 66 890

CHARACTERISTICS

- High quality melamine
- Anti-slip footing
- Polish White, Black & Ivory
- Dim. H10/W155/L295mm
- 48 units per carton

MAESTRO SOAP TRAY



MAESTRO SOAP DISH
Black
REF 8 66 1164-SD



MAESTRO Soap Dish
White
REF 8 66 1158-SD001



MAESTRO Soap Dish
Ivory
REF 8 66 1161-SD

CHARACTERISTICS

- High quality melamine
- Anti-slip footing
- Polish White, Black & Ivory
- Dim. H15/W95/L95mm
- 60 units per carton

JVD. PRODUCTS THAT CARE

Hygiene, health, wellness and more... For more than 35 years, JVD has been designing, inventing, testing, developing and manufacturing products whose sole purpose is to take care of you, your employees, your customers and your visitors.

Taking care is so deeply rooted in our culture that we also take care to protect our environment by emphasizing eco-design, being environmentally responsible and prioritizing local partners and suppliers.

This care-taking mission, so near and dear to our hearts, is expressed through our creation of products dedicated to current and future uses, and designed to last.

JVD. Products that care.



OUR PURIFIERS

JVD SMART MINERALIZATION®

JVD's technology treats all sources of pollution and contamination until they are 100% harmless. Odours, viruses, bacteria, mould, allergens, pollutants and contaminants dispersed as particulate matter in the ambient air, nothing can withstand it.

Shield®
|Collective Protection



Shield®
COMPACT
|Individual Protection

JVD AIR ORIGINS

Cutting-edge technology that meet the most demanding standards



INF B44-200



EN 16846-1



ISO 16000-37



EN 1822



ISO 16897

EVERYTHING YOU NEED TO KNOW ABOUT SHIELD PURIFIER

JVD Shield serves one single purpose: to restore your air's original purity

HOW JVD SMART MINERALIZATION® works

JVD's technology treats all sources of pollution and contamination until they are 100% harmless. Odours, viruses, bacteria, mould, allergens, pollutants and contaminants dispersed as particulate matter in the ambient air, **nothing can withstand it.**

PROTECTIVE BENEFITS: PURIFYING AIR, PRESERVING LIFE

- 1 By eliminating allergens & pollutants
- 2 By protecting the immune system
- 3 By eliminating unpleasant odours and restoring the original atmosphere and pure, clean air

SHIELD
Matt Black
REF 8 77 2127-BK



SHIELD COMPACT
Anodized Aluminium
Top Matt Black
REF 8 77 2134-BK



SHIELD'S ADVANTAGES



DESIGNED FOR YOU AND FOR OUR PLANET

Our solution was created not only to protect your health but also to preserve the environment, thanks to the fact that it uses no consumables and is manufactured with an emphasis on low impact materials



ALL THE QUALITY OF A MADE IN FRANCE PRODUCT

The entire range is devised, designed and produced by our teams in Reze, near Nantes (in Brittany). Likewise, most of the components are manufactured within a 100 kilometre radius of our plant, thanks to commitments made with our local suppliers



A RANGE CREATED BY RAMY FISHER

Ramy Fisher is the founder of RF Studio agency, was named Designer of the year in 2018 and was awarded the Orders of Arts and Letters by the French Ministry of Culture and communication in 2016

SHIELD



SHIELD
Matt Black
REF 8 77 2127-BK

AN INTUITIVE INTERFACE

FOR EASY, COMPREHENSIVE CONTROL OF YOUR AIR QUALITY



CHARACTERISTICS

- Supply voltage : 200-240V
- Power: 85 W
- Air Purification: Smart Mineralization®
- Negative ions and plasma
- Coverage selection: 20m2/40m2/60m2
- Operation mode: 8 hours continuous & Boost
- CADR Clean Air Delivery Rate: 400m³/h
- Sound level: 38-68 dBA (boost mode)
- Dimensions: H475/W300/D300mm
- Weight: 8.75 kg
- Visual indicator for change of CORE (filter)
- Every 3 years (depend on site conditions)
- HEPA filter H13
- UV-C Lamp Lifespan: Approx. 8000 hours

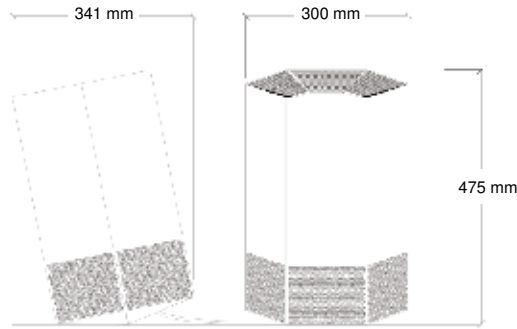

BENEFITS

By reducing the risk of cancer and endocrine disease (eliminating pollutants PM10 and PM2.5)



Neutralizing the compounds responsible for allergies; Grass and free pollens, animal hair and dust mites



Protects the immune system (fighting viruses, bacteria and mould)



Eliminates VOC, NOX, SOX, Ozone, and odours from tobacco, cooking, body etc. Restoring the original atmosphere; Pure and clean air



SHIELD COMPACT



Shield®
COMPACT

|| Individual Protection

SHIELD COMPACT
Anodized Aluminium
Top Matt Black
REF 8 77 2134-BK

CHARACTERISTICS

- Supply voltage : 200-240V
- Power : 24 W
- Equip with child lock
- Air Purification: Smart Mineralization®
- Negative ions and plasma
- Purification coverage: up to 10m²
- Ionization coverage: up to 20m²
- CADR Clean Air Delivery Rate: 37m³/h
- Airflow: 15m³/h - Boost: 37m³/h
- Wind speed: 2100 rpm - Boost: 5300 rpm
- Sound level: 37-63 dBA (boost mode)
- Dimensions: H145/W160/D125mm
- Weight: 805 gm
- Visual indicator for change of filter
- HEPA filter H13



CHARACTERISTICS

- Optional wall mounted support designed by RF Studio (Compatible with the Shield Compact)
- Eco-design and made in France
- Stainless steel



APPLICATIONS

Hotel rooms



Nursing rooms



Medical centre



Offices, open spaces





Individual Protection
**LIFE IN A BUBBLE
 HAS NEVER BEEN SO
 SOOTHING!**

**SHIELD
 COMPACT**

- 1
 CAPTURES PARTICLES
 MATTERS
- 2
 NUETRALIZES
- 3
 MINERALIZES
 MOLECULES

**POLLUTANTS
 ALLERGENS
 CONTAMINANTS
 ODORS**



PURE AIR

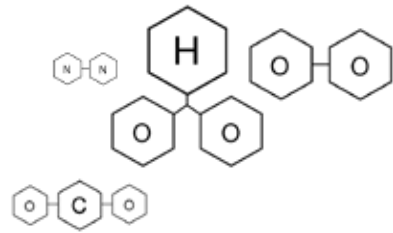

**AND PROTECTION
 OF SMALL ROOMS**



**70 % of
 CONTAMINANTS**
 purified in continuous
 mode

90 % of ODOURS
 Removed in boost
 mode

UP TO 10 M2

UP TO 20 M2

PUBLIC HAIR DRYERS

Cleverly designed and purpose-built, the Neptune hairdryer is the hallmark of product development to address the dire needs of public restrooms of swimming pool complexes and aqua themeparks.

Neptune's powerful drying performance coupled with heavy duty induction motor operation makes the dryer second to none. The ease of height and angle adjustment is the pièce de résistance of this innovative product.

Make every leaving customer a happy one with the Neptune Drying Experience!

PAGES
65 TO 73



NEPTUNE



REF 8 22 1405



NEPTUNE
White
REF 8 22 1405



ADJUSTABLE HEIGHT
OPTIMIZED TO ADAPT TO YOUNG
AND OLD ALIKE



ERGONOMIC
THANKS TO ITS ABILITY TO SPIN
180°!



EASY TO CLEAN
NO CLOGGING OF THE RAILS,
BECAUSE ALL SURFACES ARE
ACCESSIBLE

HIGHLIGHTS



ADJUSTABLE HEIGHT Optimized to adapt to young and old alike



ERGONOMIC Thanks to its ability to spin 180°!



EASY TO CLEAN No clogging of the rails, because all surfaces are accessible

- + Quiet (70 dB)
- + Longevity (induction motor)
- + Corrosion resistant in chlorinated atmospheres
- + On/off button to simplify maintenance
- + Designed specifically for public restrooms of swimming pool complexes, gyms, spas, aqua themeparks

CHARACTERISTICS

- Adjustable height
- 180° rotation
- Suitable for intensive usage
- Anti-vandalism: IK10 ABS cover
- Rated power 2000W
- Power supply 220V~240V, 50 Hz
- CE - Class II - IP23
- Support dim. H1153/L138/D148mm
- Hair dryer dim. H348/L150/D384mm



Scan me to play
the video

THE COMMON AREAS

JVD offers a broad selection of equipment for common areas, lines and colors to adapt to your environment and make it unique. Thanks to our mastery of product design to production, JVD is the only manufacturer able to offer matching sets ranging from hand dryers to sanitizer stations.



ULTIMO STATIONS



HIGHLIGHTS

- ⊕ Designed specifically for hotels, complexes, schools and all public places
- ⊕ Integrated with high visibility advisory panel
- ⊕ Stable base to avoid toppling
- ⊕ Portable or can be bolted to the ground

CHARACTERISTICS

ULTIMO STATION

- Overall Height: H1620mm
- Base: 365/365mm
- Approx. Wt. : 14.5 Kg
- With black S/S residue container
- Notification panel
(messages can be customized)
- With S/S residue container, Black color

SAPHIR Ref. 8 443 97

- Automatic, contactless, 1100ml
- ABS & PS plastic housing
- Unit flow; 1 ml/dose every 3 secs
- Transparent level viewer
- Lockable with key
- Battery operated 4 x AA cells
- Dim. H235/W140/D107mm

AVANTIS Ref. 8 44 2076

- Automatic, contactless, 600ml
- ABS & PS plastic housing
- Unit flow;
- >1ml liquid soap/dose every 3 secs
- >2ml gel alcohol/dose every 2 secs
- Black translucent window
- Lockable with key
- Battery operated, 4 x AA cells
- Dim. H197 x W110 x D80 mm



ULTIMO STATION + SAPHIR
REF 3 88 105-SA



ULTIMO STATION + AVANTIS
REF 3 88 105-AV

DISCOVER THE STATION
IN VIDEO

BY SCANNING THIS QR CODE



CLASSIC STATION



CLASSIC STATION + SAPHIR
Ref 3 88 113-SA



CLASSIC STATION + AVANTIS
Ref 3 88 113-AV

CHARACTERISTICS

CLASSIC STATION
- Overall Height: H1366mm
- Base: 365/365mm
- Approx. Wt. : 11 Kg
- With black S/S residue container

SAPHIR Ref. 8 44 397
- White dispenser 1100ml

AVANTIS Ref. 8 44 2076
- White dispenser 600ml

CLASSIC DESKTOP



CLASSIC DESKTOP + SAPHIR
Ref 3 88 110-SA



CLASSIC DESKTOP + AVANTIS
Ref 3 88 110-AV

CHARACTERISTICS

CLASSIC DESKTOP
- Overall Height: H350/W160/D137mm
- Approx. Wt. : 5 Kg
- With black S/S residue container

SAPHIR Ref. 8 44 397
- White dispenser 1100ml

AVANTIS Ref. 8 44 2076
- White dispenser 600ml

AUTOMATIC DISPENSERS



AVANTIS Automatic
Ref 8 44 2076
UPC 40



SAPHIR, Automatic
Ref 8 44 397
UPC 12

CHARACTERISTICS

- Automatic, contactless
- ABS & PS plastic housing
- Transparent level viewer
- Lockable with key
- Battery operated 4 x AA cells

SAPHIR Ref. 8 443 97
- Capacity 1100ml
- Unit flow; 1 ml/dose every 3 secs
- Dim. H235/W140/D107mm

AVANTIS Ref. 8 44 2076
- Capacity 600ml
- 1ml liquid soap/dose every 3 secs
- 2ml gel alcohol/dose every 2 secs
- Dim. H197 x W110 x D80 mm

BUDDYCART

Made to last the rigours of day to day cleaning, the new BuddyCart is designed to be a trusted assistant of a modern-day housekeeper



BUDDYCART
Black
REF HBC-3 00 253-BK



CADDY BAG
Black
REF HBC-3 00 253-CADDY



CHARACTERISTICS

- Dimensions: H670/W360/D425mm
- Made of Water, oil and dust resistant PVC material
- Top cover fitted with a hasp and staple mechanism for optional locking with padlock
- Aluminium telescopic handle
- 2 Robust ball bearing PVC wheels designed to reduce noise and for heavy duty use
- Heavy Duty Reinforced Rubberised Kick Plate reduces wear and tear
- Removable Synthetic Resin Inner Liner - removable for easy cleaning

Configurations:

- Front zipper Bag
- 3 waterproof bottle holders
- 1 side compartment collateral slot
- 1 back compartment, 3 adjustable dividers
- 6 inner pockets with netting
- 1 handy storage caddy bag

HOUSEKEEPING CARTS, METAL

HOUSEKEEPING CART
Anthracite Grey
REF HC-3 00 241-AG



CHARACTERISTICS

- Metal construction
- Epoxy power-coated
- With top organizer
- Full bag & 3/4 bag with zippers
- Metal lid on bags to contain odour
- 3 fixed shelves as standard
- Full wrap-around rubber bumper
- 8" solid wheels (2 fixed, 2 swivel)
- Swivel with brakes
- 4x4" revolving corner bumper wheels
- Weight approx. 42 Kg
- Load capacity up to 100 Kg
- Anthracite grey finishing
- Partial unassembled for shipment
- 1 unit per carton

Ref: HC-300 241-AG
Dim. H1150/L1410/D500mm

Ref: HC-300 241-DTC-AG
Dim. H1200/L1410/D500mm
Lockable top organizer
Lockable double-leaf doors

Ref: HC-3 00 241-DTC-BD-AG
Dim. H1200/L1410/D500mm
Lockable top organizer
Lockable double-leaf doors
Lockable base drawer

* All locks are with key-alike system

HOUSEKEEPING CART
Anthracite Grey
REF HC-3 00 241-DTC-AG



HOUSEKEEPING CART
Anthracite Grey
REF HC-3 00 241-DTC-BD-AG



Metal lid over bag to contain odour



HOUSEKEEPING CARTS PLASTIC



HOUSEKEEPING CART
Black
REF **HCP-3 00 250-BK**



HOUSEKEEPING CART
Black
REF **HCP-300251-DR-BK**

CHARACTERISTICS

- Strong polypropylene material (PP)
- Dim. H1280 /L1560/ W540mm
- Removable metal top organizer
- Lockable metal base drawer
- 1 fixed shelf as standard
- 2 full bags with high quality zippers
- Bags with carriers for easy lifting
- 8" special PP wheels (2 fixed, 2 swivel)
- 4 revolving corner bumper wheels
- Approx. weight 60 Kgs
- Load capacity up to 150 Kg
- Black color
- Unassembled for shipment
- 1 unit per carton

Ref: **HCP-300250-BK**
Top organizer & base drawer included

Ref: **HCP-3 00 251-DR-BK**
Top organizer & base drawer included
With lockable double-leaf doors

MINIBAR REFILL CART



MINIBAR REFILL CART
Anthracite Grey
REF **MRC-3 00 252-AG**

CHARACTERISTICS

- Metal construction
- Epoxy power-coated
- Lockable double-leaf doors
- Lockable top organizer
- 3 adjustable pull-out roller shelves
- 8" solid wheels (2 fixed, 2 swivel)
- Swivel with brakes
- 4 x 4" revolving corner bumper wheels
- Weight approx. 85 Kg
- Load capacity 54 cans per shelf
- Anthracite grey finishing
- Dim. H1310/L940/W535mm
- Unassembled for shipment
- 1 unit per carton

* All locks are with key-alike system

LINEN & X-TROLLEY



LINEN TROLLEY
REF **LTW-3 00 549-UB**



X TROLLEY
REF **LTW-3 00 546-UB**

CHARACTERISTICS

- Ref: **LTW-3 00 549-UB**
- Strong steel tube 25mmØ
 - Black powder-coated
 - Rust resistant
 - 4" wheels (2 solid & 2 swivel)
 - Water-resistant bag in black
 - Dim. H900 x L1000 x D700mm
 - Approx. weight 45Kg
 - Ship assembled
 - 1 unit per carton

CHARACTERISTICS

- Ref: **LTW-3 00 546-UB**
- Strong steel tube 25mmØ
 - 4" solid wheels x 4 (2 with brakes)
 - Water-resistant bag in black
 - Dim. H880 x L880 x D500mm
 - Approx. weight 12 Kg
 - Ship assembled
 - 1 unit per carton

LAUNDRY TROLLEY



LAUNDRY TROLLEY,
REF **LT-3 00 236**



LAUNDRY TROLLEY
REF **LTW-3 00 237**

CHARACTERISTICS

- Stainless steel 201 grade
- Rust resistant
- 4" swivel wheels with brakes
- Ship unassembled
- 1 unit per carton

- Ref: **LT-300 236**
- Dim. H1710/L1200/D580mm
 - Approx. weight 7.8 Kgs

- Ref: **LT- 300 237**
- Dim. H1510/L1090/D500mm
 - Approx. weight 27.7 Kgs

MULTI PURPOSE CART



REF MP-3 00 220



CHARACTERISTICS

- Multi-purpose usage
- Complete with tool basket organizer MP-300229
- Strong polypropylene
- Solid wheels
- Vinyl bag included
- Weight 15 Kg
- Ship unassembled
- 1 unit per carton

DUST PAN & BROOM

REF DB-3 00 222



CHARACTERISTICS

- Strong polypropylene material
- Dust pan with handle
- Durable rear wheels
- Self-opening and closing lid
- Conceals dirt and debris
- Broom included
- 1 unit per carton

FLOOR SIGNS



REF FS - 3 00 223



REF FS - 3 00 224



REF FS - 3 00 225

CHARACTERISTICS

- Strong polypropylene material
- Warning messages on both sides
- Foldable, space saving
- Bright Yellow color
- 1 unit per carton

Ref: FS-300 223
- CAUTION

Ref: FS-300 224
- CAUTION WET FLOOR

Ref: FS-300 225
- CLEANING IN PROGRESS

MOBILE CONTAINER



Ref MC- 3 00 401
80 L, Grey
Ref MC- 3 00 403
168 L, Grey

CHARACTERISTICS

- Strong plastic material
- Great mobility
- Easy to move heavy loads
- Reinforced rims for added strength
- Resists rust, chips and dents
- With built-in handles
- A dolly screws on base container
- Dolly with heavy-duty swivel wheels
- Ship semi-assembled
- 1 unit per carton

Ref: MC-300 401
- Grey container, 80L
- Dim. H740/L510/W400mm
- Approx. Weight 5.8 Kgs

Ref: MC-300 403
- Grey container, 168L
- Dim. H920/L710/W610mm
- Approx. Weight 9.5 Kgs

SERVING TROLLEY



REF MP-3 00 227
H935/L815/W410 mm
Grey



REF MP-3 00 228
H950/L0.35/W500 mm
Grey

CHARACTERISTICS

- Strong plastic material
- Lightweight, aluminium
- Easy-grip handles
- Quiet, non-marking swivel wheels
- Black refuse bins included
- Great mobility
- Resists rust, chips and dents
- Ship unassembled
- 1 unit per carton

Ref: MP-300 227
- Grey cart, Black bins
- Dim. H935/L815/W410mm

Ref: MP-300 228
- Grey cart, Black bins
- Dim. H950/L1035/W500mm

LUGGAGE CARTS



LUGGAGE CART
Gold Chrome
REF LCU-3 00 505



LUGGAGE CART
Silver Chrome
REF LCU-3 00 504

CHARACTERISTICS

- Stainless steel 38mmØ tubing
- Deck carpeted
- Rubber bumper all-round
- 8" pneumatic wheels (2 fixed, 2 swivel)
- 250mm ground clearance
- Weight 40 Kg, maximum load 250Kg
- H1900/L1140/W670mm
- Ship unassembled
- 1 unit per carton

Ref: LCU-300 504
- Silver Chrome, Black carpet

Ref: LCU-300 505
- Gold Chrome, Red carpet

BIRDCAGE



CLASSIC BIRDCAGE
Silver Chrome
REF LCU-3 00 502

CHARACTERISTICS

- Ref: LCU-300 502
- Classic Birdcage
 - Stainless steel 38mmØ tubing
 - Deck carpeted
 - Rubber bumper all-round
 - 8" solid wheels (2 fixed, 2 swivel)
 - 250mm ground clearance
 - Weight 38 Kg, maximum load 250Kg
 - H1860/L1050/W610mm
 - Silver Chrome, Black carpet
 - Ship unassembled
 - 1 unit per carton



DELUXE BIRDCAGE
Gold Chrome
REF LCU-3 00 501

CHARACTERISTICS

- Ref: LCU-300 501
- Deluxe Birdcage
 - Stainless steel 50mmØ tubing
 - Deck carpeted
 - Rubber bumper all-round
 - 8" pneumatic wheels (2 fixed, 2 swivel)
 - 250mm ground clearance
 - Weight 53 Kg, maximum load 350Kg
 - H1950/L1140/W670mm
 - Gold Chrome, Red carpet
 - Ship unassembled
 - 1 unit per carton

HAND TRUCKS



HAND TRUCK
Gold Chrome
REF HTU-3 00 509

HAND TRUCK
Silver Chrome
REF HTU-3 005 08

CHARACTERISTICS

- Stainless steel 38mmØ tubing
- Deck carpeted
- Foldable platform
- Carpet replaceable
- Hanging hook
- 10" pneumatic wheels
- Weight 16.5 Kg, maximum load 200Kg
- H1220/L400/W500mm
- Ship unassembled
- 1 unit per carton

Ref: HTU-300 508
- Silver Chrome, Black carpet

Ref: HTU-300 509
- Gold Chrome, Red carpet

QUEUE POLES



QUEUE POLE
Silver Chrome
REF QPU-3 00 511

QUEUE POLE
Gold Chrome
REF QPU-3 00 512

CHARACTERISTICS

- Stainless steel construction
- Polish chrome with Silver hook (QPU-300511)
- Gold plating with Gold hook (QPU-300512)
- Pole height: 1000mm
- Base diameter: 320mm
- Weight: 11 Kg
- Ship unassembled
- 10 units per carton

- Braided rope
- Belt length 1500mm
- Black below, silver hook (QRU-300533)
- Red belt, gold hook (QRU-300534)

BAGGAGE NET



BAGGAGE NET
Brass Gold
REF BN-3 00 510

CHARACTERISTICS

- Strong nylon
- Brass gold color
- 3 x 3 metre length
- 10 units per carton

DECORATIVE BINS



DUSTBIN
Nickel Black
REF **PB-3 00 420**



DUSTBIN
S/S Matt
REF **PB 3 00 423**

CHARACTERISTICS

- Decorative in-door use
- Stainless steel material
- Finger-print resistance
- Inner liner included
- 1 unit per carton

Ref: PB-300 420

- 30 litre, H700/W320/D260mm
- Nickel Black finishing

Ref: PB-300 423

- 28 litre, H670/305mm
- S/S Matt finishing

PRO INSECT KILLER



PRO INSECT KILLER
30W S/S
REF **8 55 625**



PRO INSECT KILLER
40W S/S
REF **8 55 627**

CHARACTERISTICS

- Stainless steel construction
- High quality true UV lights
- Voltage 230V, 50 Hz
- Grid voltage 3800V/10mA
- 2 tubes per device
- Wall-mounted or suspended
- On/off switch, cord with plug
- Class 1, IP20
- 2 units per carton

Ref: 855 625

- 30W (2 x 15W), protected area 80m²
- Dim. H325/L515/D70mm

Ref: 855 627

- 40W (2 x 20W), effective area 120m²
- Dim. H365/L660/D70mm

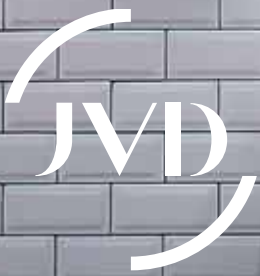

HYGIENE



AVANTIS AUTOMATIC



AVANTIS Automatic
Ref **8 44 2076**
UPC 40

CHARACTERISTICS

- Avantis automatic, contactless
- Soap dispenser 600ml
- ABS & PS plastic housing
- Unit flow;
- >1ml liquid soap/dose every 3 secs
- >2ml gel alcohol/dose every 2 secs
- Black translucent window
- Lockable with key
- Battery operated
- 4 x AA cells
- Dim. H197 x W110 x D80 mm

SAPHIR AUTOMATIC



SAPHIR, Automatic
Ref **8 44 397**
UPC 12

CHARACTERISTICS

- Saphir Automatic
- Soap dispenser 1100ml
- ABS & PS plastic housing
- Unit flow; 1 ml/dose every 3 secs
- Transparent level viewer
- Lockable with key
- Battery operated 4 x AA cells
- Dim. H235/W140/D107mm

MANUAL DISPENSERS



OPAL Single
Ref **8 44 1808**
S/S Matt, UPC 24



SAVINOX
Bright Chrome
Ref **8 44 253/254**
UPC 40/50

CHARACTERISTICS

Opal Soap dispenser 500ml

- S/S 304 Matt finishing
- Transparent window
- Lockable with key
- Dim. H241/L100/D122mm
- Engraved with "HAND SOAP"

Savinox Soap dispenser

- S/S 304 Bright Chrome
- Viewer
- REF: 844 253 (450ml)
Dim. H169/W90/D115mm
- REF: 844 254 (850ml)
Dim. H182/W105/D115mm

OPAL DISPENSERS



OPAL Single, Manual
REF 8 44 1809-V2
UPC 24



OPAL Duet, Manual
REF 8 44 1813-V2
UPC 24



OPAL Trio, Manual
REF 8 44 1814-V2
UPC 24

CHARACTERISTICS

- Liquid Dispenser 500ml
- Plastic silver with matt S/S 304 housing
- Zinc handle
- Pull to dispense
- Unit flow; 2 ml per pump
- Transparent window
- Key to unlock to refill
- 4 anti-moisture labels included:
Hand Wash/ Body Wash/ Shampoo/
Conditioner
- REF: 8 44 1809-V2
OPAL Single, H241/L122/D100mm
- REF: 8 44 1813-V2
OPAL Duet, H241/L216/D100mm
- REF: 8 44 1814-V2
OPAL Trio, H241/L310/D100mm

CLEANLINE DISPENSERS



CLEANLINE Mousse
Ref 8 44 478
White, UPC 24



CLEANLINE Gel
Ref 8 444 79
White, UPC 24

CHARACTERISTICS

- Cleanline 700ml
- Robust ABS
- 3,000 doses mousse
- Flow rate; 1ml or 0.5ml doses
- Viewer window
- Lockable with key
- HACCP Standard
- Dim. H206/W100/D106mm



FOAM

FOAM ALLOWS TO DIVIDE
SOAP CONSUMPTION BY
AS MUCH AS 8 TIMES



PRACTICAL

EASY TO REFILL
AND CLEAN THANKS TO
ITS REMOVABLE CONTAINER

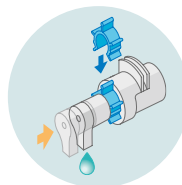

ECONOMIC

THE FLOW REDUCER
ALLOWS TO HALVE
CONSUMPTION OF GEL SOAP

OUR HAND DRYERS

A hand dryer should not be chosen at random. Whether your constraints relate to usage, maintenance, noise or vandalism resistance, we have a large array of equipment suited to your environment.

EVERYTHING YOU NEED TO KNOW TO CHOOSE THE RIGHT HAND DRYER



VANDALISM RESISTANCE

In some places, special attention needs to be given to vandalism resistance. **Standard NF EN 62262 provides a clear interpretation of this level of resistance with the IK index. IK10 is the highest level of resistance.** A device of this type is able to tolerate at least a blow from a 5 kg sledgehammer. Devices with an aluminium or steel cover are even more resistant.

HOT OR COLD AIR

If the washroom in question has little to no heating, a cold sensation during hand drying can be unpleasant. And so we recommend opting for a hand dryer which uses evaporation or jet air with a heating element.

NOISE

The sound of a hand dryer can become a nuisance if located nearby an office or restaurant dining room. Most hot air hand dryers are relatively quiet. Some jet air hand dryers also manage to combine power with a low noise level.

HAND DRYERS VS PAPER TOWELS

Electric hand dryers offer the most responsible way to dry one's hands.

0 consumables | **10 times less** | **Up to 75% lower**
 0 waste | expensive than paper | carbon emissions

USAGE LEVEL

A hand dryer should provide a solution which is compatible with the level of usage of the washroom.

- **For places with little usage** (< 50 visits daily), all three solutions are possible.
- **For places with normal usage** (50-250 visits daily), the cost of paper becomes prohibitive.
- **For places with high usage** (250-400 visits daily), jet air hand dryers are the only solution capable of guaranteeing cost control and a fast drying time.
- **Lastly, for places with intensive usage** (> 400 visits daily), the chosen hand dryer should have a brushless motor or an induction motor.

ECOLOGICAL FOOTPRINT

It takes 17 trees to produce one tonne of paper. Its manufacturing and transport then generate significant amounts of CO2. For example, the French leader in paper consumables generates 30,000 tonnes of CO2 annually, just to transport its paper within France. In this respect, hand dryers are the ideal solution for reducing your ecological footprint.

Next-gen jet air hand dryers consume very little energy, and the absence of consumables renders the impact of transport anecdotal at best.

INITIATIVE EAU&VIE

JVD joins the Eau&Vie association in its fight for permanent access to quality running water and the development of collective awareness about the importance of hygiene in deprived urban neighbourhoods. **We also wanted to contribute to the dissemination of our values by engaging our clients in this common perspective.** Therefore, we have joined forces with the Eau&Vie association and set up a partnership to fight for access to running water for all.



For every hand dryer in the Air range (Exp'Air, Stell'Air, Copt'Air and Sup'Air) purchased a hygiene kit will be distributed in underprivileged neighbourhoods in the Philippines.

TORNADE



TORNADE
Off White
REF 8 11 251
UPC 6



TORNADE
Bright Chrome
REF 8 11 292
UPC 6

HIGHLIGHTS

- + Hot air
- + Suitable for intensive usage
- + Quiet (70 dB)

CHARACTERISTICS

- Tornado Hand Dryer
- Power 220V~240V 50/60Hz
- Rated power 2400W
- Noise level 70 dBA
- EC-CLASS II-IP23
- Induction motor
- Drying time 20~30 seconds
- Lighting of the drying zone
- Anti-vandalism
- H302/W265/D149mm

MASTER



MASTER
Off White
REF 8 11 413
UPC 6



MASTER
Bright Chrome
REF 8 11 414
UPC 6

HIGHLIGHTS

- + Hot air
- + Suitable for intensive usage
- + Quiet (70 dB)
- + Anti-vandalism (aluminium cover)

CHARACTERISTICS

- Master Hand Dryer
- Power 220V~240V 50/60Hz
- Rated power 2600W
- Noise level 70 dBA
- EC-CLASS II-IP23
- Induction motor
- Drying time 20~30 seconds
- Lighting of the drying zone
- Anti-vandalism
- H265/W265/D130mm

ZEPHYR II



ZEPHYR II
Off White
REF 8 11 1401
UPC 6

CHARACTERISTICS

- Zephyr II Hand Dryer
- Power 220V~240V 50/60Hz
- Rated power 2100W
- Noise level 70 dBA
- IP23, Class II
- Universal motor
- Airflow 190m3
- ABS-PC
- H280/W205/D200mm

AIRWAVE | ECODESIGN



AIRWAVE
White
REF 8 11 707
UPC 4

HIGHLIGHTS

- + Ultra-fast drying
- + Automatically activatable heating element
- + Water recovery tray

CHARACTERISTICS

- Power 220V ~ 240V 50/60Hz
- Rated power 1400W
- Noise level 77 dBA
- EC -CLASS IHP24
- Air speed 360 km/hr
- Drying time 20 ~ 25 seconds
- Anti-vandalism

ALPHADRY | ECODESIGN



ALPHADRY AUTOMATIC
Metal grey
REF 8 11 906



ALPHADRY AUTOMATIC
White
REF 8 11 905

HIGHLIGHTS

- + Suitable for intensive usage (digital / brushless motor)
- + Activatable heating element
- + Water recovery tray

CHARACTERISTICS

- Power 220V ~ 240V 50/60Hz
- Rated power 2050W
- Noise level 80 dBA
- EC -CLASS IHP21
- Ultra-fast drying time
- Drying time 10 ~ 15 seconds
- Brushless motor
- Anti-vandalism ABS IK10
- Integrated HEPA air filter
- Blue light on drying zone
- H685/W300/D220mm



+ ALPHADRY HEPA FILTER
REF 5 10 2010



LIGHTING
OF DRYING
ZONE



HYGIENIC
INTEGRATED HEPA FILTER AND
WATER TANK

SOME OF OUR CLIENTS AROUND THE WORLD



Fairmont,
Monte-Carlo



Mondrian Shoreditch London, Londres



The David Kempinski,
Tel Aviv



Sofitel City Center, Singapore



Guanahani Hotel,
St. Barth



Régina Biarritz Hôtel & Spa - MGallery,
Biarritz



Logo & Trademark Disclaimer:

Product names, logos, brands and other trademarks featured in this catalogue are the property of their respective trademark holders. It is for reference only and serves no other purposes.

General Disclaimer:

Reasonable efforts are used to include accurate and up-to date information in this catalogue. They may contain technical inaccuracies or typographical errors. We do reserve the rights to change the information without prior notification or any obligation. In no event will JVD or its subsidiaries be liable to any part for any damages whether direct or indirect, consequential, punitive or others for use of its contents.



It is our privilege to serve

THE FRENCH TOUCH

AUSTRALIA

Aiden Hotel Sydney
Branksome Hotel & Residence, Sydney
Conrad Hotel, Bora Bora
Crown Tower & Casino, Perth
Crown Tower Sydney
Crowne Plaza Adelaide
Crowne Plaza Darling Harbour
Crowne Plaza Hawkesbury
Crowne Plaza Lasseters, Alice Springs
Crowne Plaza Port Moresby
Dorsett Hotel Gold Coast
Doubletree by Hilton, Melbourne
Eatons Hill Hotel, Brisbane
Elements Richmond by Westin, Melb.
Emporium, Brisbane
Four Seasons Sydney
Fraser Suites, Sydney
Fullerton Sydney
Grace Hotel Sydney
Grand Hyatt Melbourne
Hilton Little Queen Street Melbourne
Hilton Port Moresby
Holiday Inn Express Adelaide
Holiday Inn Express Brisbane
Holiday Inn Express Melbourne
Holiday Inn Express Queenstown
Holiday Inn Express Sydney
Hotel Urban, St. Leonards
Hotel X Brisbane
Hyatt Centric Melbourne
Hyatt Regency, Sydney
Hyde Park Inn, Sydney
Indigo Adelaide
Indigo Brisbane
Ink Hotel by Next Story, Melbourne
InterContinental Hotel Double Bay
InterContinental Perth
InterContinental Rialto, Melbourne
InterContinental Sanctuary Cove
InterContinental Sorrento
InterContinental Sydney
Jupiters Casino & Hotel, Gold Coast
Kokomo Resort, Yaukuve Island
Le Meridien Melbourne
Little National Hotel, Canberra
Little National Sydney
M Gallery by Sofitel
Mandooon Estate Western Australia
Mantra SILO Hotel Launceston
Marion Hotel Adelaide
Marriott Momi Bay Resort, Fiji
Marriott Surfers Paradise
Marsden Hotel Burwood
Next Hotel Brisbane
NEXT Hotel Melbourne
Novotel Brighton-le-Sands
Novotel Rockford, Darling Harbour
Oakwood Hotel & Residences Melb.
One&Only Hayman Island Resort
Oval Hotel Adelaide
Ovolo 1888, Sydney
Ovolo The Valley, Brisbane
Ovolo Woolloomooloo, Sydney
Palazzo Versace Gold Coast
Park Hyatt Sydney
Pier One Sydney, Autograph Collection
QT Hotel, Melbourne
Quay Perth
Ritz Carlton Perth
Sequia, Adelaide
Sheraton Grand Mirage Gold Coast
Sheraton on the Park, Sydney
Six Senses Resort Mololo, Fiji
Sky City Casino Adelaide
Sky City EOS Adelaide
Skye Hotel Suites, Green Square
Skye Hotel Suites, Parramatta
Skye Hotel Suites, Sydney
Sofitel Darling Harbour, Sydney
Sofitel Melbourne
Sofitel Wentworth, Sydney

AUSTRALIA

Spicers Potts Point
Swissotel Sydney
The Darling (Star), Gold Coast
The Little National Sydney
The Old Clare Hotel, Sydney
The Oval Hotel Adelaide
The Pacific Manly Sydney
The Tasman Luxury Collection Hobart
The West Hotel, Curio by Hilton
W Hotel Melbourne
W Hotel, Brisbane
William Inglis Hotel

BAHRAIN

Al Dana Novotel Resort
Al Safir Hotel
Crowne Plaza
Delmon International Hotel
Downtown Rotana
Dragon Hotel Amwaj
Elite Hotels Group
Gulf Executive Residence Juffair
Gulf Air Lounge
Gulf Hotel
Hawar Golden Tulip
Intercontinental Regency
Majestic Arjaan Rotana
Movenpick Hotel
One Juffair Service Apt.
One Pavilion Service Apt
Radisson Blu, Bahrain
Ramee Hotels
Rasafa Tower Service Apt.
S Hotel Bahrain
Swiss-Bel Residences Juffair
Swiss-BelHotel Seef
Tulip Inn Hotel

BANGLADESH

Best Western, Dhaka
Dhaka Golf Club
Grand Sultan Resort & Golf
Hansa By Unique
Holiday Inn Dhaka
Inn Dhaka Hotel Long Beach
Lakeshore Banani Hotel
Le Meridien Dhaka
Radisson Bay & Radisson Blu
Renata Guest House
Royal Park Hotel
Sheltech HRC Hotel
Sheraton Dhaka
Six Seasons Hotel, Dhaka
The Daily Star
The Palace Resort & Spa Hotel
Westin Dhaka Hotel

CAMBODIA

1920 - Hotel Siem Reap
Amansara Resort
Angkor Note Boutique
Apsara Angkor Hotel & Resorts
Asarita Angkor Resort & Spa
Central Suite Residence
Chronicle Angkor Hotel
Courtyard by Marriott Phnom Penh
Dinata Angkor
Golden Temple Hotel
Golden Temple Retreat
Hanuman Alaya Villa
Himawari Hotel & Apartment
HM Grand Central Hotel
Khmer Mansion Boutique Hotel
Kolapsor Hotel, Phnom Penh
La Riviere d' Angkor
Le Meridien Angkor Siem reap
LYNAYA Urban River Resort
Marriott Courtyard Phnom Penh
Memoire Palace Resort & Spa
Metta Residence
Naga World Hotels & Casino

CAMBODIA

Natalya Holiday Villa & Resorts
Natural House Siem Reap
Nita By Vo Luxury Hotel
Paris Angkor Hotel
Park Hyatt Siem reap
Prince D'Angkor Siem reap
Princes Hotel
Rey Angkor Boutique
Royal Angkor Resort & Spa
Sabara Angkor Resort & Spa
Sarai Resort & Spa
Silver Palms Residence Siem Reap
Sokha Hotels & Salina Hotel
Somadevi Angkor Siem Reap
Sunway Hotel, Phnom Penh
The Avairy Hotel Siem Reap
The Green Corner Residence
The Night Boutique Hotel
Tree Palace Hotel, Kep

CHINA

Ascott GZ, Ascott Shanghai
Ascott Nantong & Dongguan
Banyan Tree Huangshan Hotel
Beijing Winter Olympics Hotel
Changsha Shimao Hilton Hotel
China World Hotel
Citadines Chongqing & GZ
Citadines New District Wuxi
Citadines Shaoxing
Conrad Shenyang
Double Tree by Hilton, Beijing
Fraser Suites Dalian & Nanjing
Grand Hyatt Sanya
Grand Mercure Shanghai
Haytt Regency Hainan Ocean Resort
Hilton Ningbo & Yanta
Holiday Inn Beijing, Dalian, Hefei
Howard Johnson Suzhou, Ya-an
Hyatt Beijing, Jiading & Zhuhai
Hyatt Centric Lakeside Ningbo
IBIS Beijing, Shanghai, Nanjing
Indigo Hainan
JW Marriot Beijing
Kempinski Hotel Nanjing
Kempinski Hotel Wuxi, Sanya
Le Meridien Hangzhou
Lijing Jianguo Hotel Jilin
Marco Polo Hotel, Xiamen
Mercure Hotel Shanghai
MiniMax Premier Hotel Chengdu
Moxy Nanjing Hotel
Moxy Shenzhen Hotel
Ocean Park Hotel Shanghai
PuXuan Hotel Beijing
Radisson Hotel Shaoxing
Regent Suzhou
Shanghai Warner Hotel
Shangri-la Hotel, Beijing Shougang
Shangri-la Hotel, Putian
Shangri-la Hotel, Shanghai Pudong
Sofitel Suzhou
Somerset Southbay Zhuhai
Somerset Suzhou Bay Suzhou
Somerset Xuhui Riverside Shanghai
Somerset Chongqing, Tianjin
Suzhou Conference Center Hotel
Swissotel Kunshan
Taixing jinling international Hotel
The Portman Ritz-Carlton SH
The Ritz-Carlton Beijing
Wyndham Taixing
Zhuhai Holiday Resort Hotel

GUAM & SAIPAN

Aqua Resort Saipan
Coral Ocean Golf & Resort
Dusit Thani Guam
Fiesta Hotel Guam
Guam Plaza Resort & Spa
Guam Reef & Olive Spa Resort

GUAM & SAIPAN

Hafadai Beach Hotel
Hilton Guam Resort & Spa
Holiday Resort Guam
Hotel Nikko Guam
Hyatt Regency Guam & Saipan
Kensington Hotel Saipan
Laolao Bay Golf & Resort
Marianas Resort/Spa Saipan
Nikko Hotel Guam
Onward Beach Resort Guam
Pacific Island Club Saipan
Pacific Star Guam
Saipan World Resort
The Hyatt Hotel, Guam
The Westin Hotel, Guam
World Resort Saipan

HONG KONG & MACAU

Ascott Hong Kong
Auberge Hotel & resort
Best Western Sun Sun Macau
Citadine Mercer Hong Kong
Conrad Hong Kong, Macau
Dorsett Hotel, Eaton Hotel
Emperor Hotel Macau
Emperor Hotel Wanchai
Four Points Sheraton, Tung Chung
Galaxy Macau
Gleneagles Hospital
Grand Lisboa Macau
Harbour View Hotel, Macau
Hard Rock - City of Dreams
Holiday Inn HK/Macau
Hotel De Edge
Landmark Hotel, Macau
Metropark Hotel Mong Kok
Murray Hotels Hong Kong
Ovolo Hotels
Parisian Macau
Rosedale By the Park
Sheraton Hotel, Tung Chung
St. Regis Macau
Studio City Macau
Venetian Macau
Wynn Macau

INDIA

Aiila Diwa - Goa/Bishangarh
Aloft Aerocity, Goa
Ambassador Hotel Mumbai
Bansai Hotel Chandigarh
Best Western Visakhapatnam
Bloom Hotel, Bangalore, Goa
Bristol Hotel Gurgaon
Byke Hotel Junagadh, Mumbai
Carlson Hotels (various States)
Centre Point, Srinagar
Chao Palace Hotel Ladakh
Check Inn Hotel
Citadines Bangalore
Citrus Hotels & Resorts Gurgaon
Clarens Hotel Gurgaon
Clarion Hotel Delhi
Clarks Hotels (various States)
Conrad, Pune
Country Inn & Suites (various States)
Courtyard by Marriot (various States)
Crowne Plaza Today (various States)
Crystal Sarovar Premiere Agra
CY Marriott Amritsar & Bhopal
Dan Hotels
Double Tree by Hilton (various States)
Dusit Delhi
Fairfield by Marriot (various States)
Falna Resort Pali
Fern Residency Jaipur
Fortune Hotels Kochi & Various
Four Points Aurangabad & Others
Four Seasons Hotel, Mumbai
Ginger Hotels (various States)
Golden Tulip Khajurah & Various



It is our privilege to serve

THE FRENCH TOUCH

INDIA

Grand Hyatt IREO Gurgaon
Grand Hyatt Mumbai
Grand Mercure (various)
Grand Meridien, Varanasi
Grapevine Varanasi & Various
GRT Grand Hotel - Chennai
Guestline Hotels Mumbai
Hilltone Hotel Mount Abu
Hilton Goa, Delhi & Various
Holiday Inn (various)
Holiday Inn Express (various)
Hotel The Royal Plaza Delhi
Hyatt (various)
Hyatt Aerocity Delhi & Pune
Hyatt Place Dharamshala
Hyatt Regency, Bangalore
IBIS Hotels (various)
Imperative Hotel Delhi
Imperial Hotel Delhi
Intercontinental Hotels (various)
ITC Hotels (various)
Jaypee Hotels (various)
Jhelum Resorts, Jammu
JW Marriot Hotels (various)
Keys Hotels (various)
Kohinoor Continental Hotel Mumbai
Laguna Resorts Pune
Le Meridien Delhi & Hyderabad
Lemon Tree Pune, Mumbai & Various
Mango Hotel Haridwar & Various
Mansingh Hotels (various)
Marina Hotel (IHG) Agra
Marriot Renaissance, Ahmedabad
Mercure, Sriperumbudur
Movenpick Hotel, Bangalore
Nataraja Hotel Rishikesh
Nest Hotels & Resorts, Kodaikanal
Novotel Hotel (various)
Novotel, Aerocity
Oakwood Premier Bangalore
Paramount Hotel Guwahati
Park Hyatt Goa/Chennai
Pine Retreat Mussoorie
Premier Inn, Delhi
Radisson Blu Delhi
Radisson Hotels (various)
Raffles Square, Goa & Pune
Rajsthali Resort & Spa Jaipur
Ramada Hotels (various)
Red Fox Hotels (various)
Regeneta Belgam
Regent Hotel Rajkok
Renaissance Hotel Mumbai
Ritz Carlton, Pune
Royal Orchid Hotels (various)
Sahara Star - Mumbai, Pune
Sai Grandeur, Mumbai
Sarovar Hotels (various)
Sayaji Hotel Vadodara & Indore
Shahpura House Jaipur
Shangri-La's Eros Hotel, Delhi
Sheraton Bangalore
Sheraton Grand Pune
Simm Samm Hotel, Mumbai
Sofitel Mumbai
ST. Regis Hotel Mumbai
Sterline Kota/Mount Abu
Sterling Hotels (Pan India)
Summit Hotel Shimla
Surya Salt Jaipur
Taj, Darjeeling, Theog
Taj Jai Mahal Palace
Taj Rambagh Palace
Taj Vivanta President Mumbai
Taj Vivanta, Guwahati
Taj Vivanta, Mumbai
Tamara Hotel Trichy
The Claridges Delhi
The Corbett Hotels
The Fern Hotels (various)
The Grand Sheraton Chennai

INDIA

The Grand, Delhi
The Lalit, New Delhi, Mumbai
The Landmark Hotel Kanpur
The Manor Hotel Delhi
The Oberoi (various)
The Orchid Jadhav Garth
The Park Hotel (various)
The Riverwood Forest Retreat
The St. Regis Mumbai
The Ultimate Traveling Camp
The Umroa Hotels & Resorts
The Westin - Mumbai, Delhi
Tribute Marriott Kochi
Trident Hotels - Various
Tube Rose Radisson Gurgaon
Umaid Mahal Jaipur
Vegtreast Hotel Mumbai
Welcome, Dwarka
Wow Hotel, Indore

INDONESIA

Accor Vacation Club
Alila Hotels (various)
Aloft Simatupang
Amnaya Benoa
Andaz Bali
Arosa Bintaro
Artotel Hotel
Aryaduta Bali & Various
Ascott (various)
Aston (various)
Atlet Century Park, Jakarta
Avenzel Hotel Cibubur
Aveon Malioboro Jogjakarta
Ayana, Labuan Bajo
Ayodya Resort
Bali Nirwana Resort
Banyan Tree Ungasan Bali
Batiqa (various)
Best Western (various)
Borobudur Hotel Jakarta
Bvlgary Resort Bali
Ciputra Hotel (various)
Citadines Bali
Club Med Hotels
Como Uma Canggu - Bali
Conrad Resort Bali
Crowne Plaza Semarang
Dash Hotel Seminyak - Bali
Double Tree Surabaya
Doubletree Jakarta
Fairfield, Belitung
Fairmont Jakarta
Fave Hotels Sorong & Various
Four Season Hotel Jakarta
Gaia Bandung
Gajah Mada Hotel Lumajang
Grand Aston (various)
Grand Hyatt Jakarta & Various
Grand Kempinski, Jakarta
Grand Mercure Margorejo Surabaya
Grand Sol Marina, Jatake
Grand Zuri (various)
Harmoni Hotels, Hard Rock Bali
Harris (various)
Hideaway Villa
Hilton Bandung
Holiday Inn & Express (various)
Holiday Inn Express Matraman
Holiday Inn Suites Glodok
Horison Cileduk, Tangerang
Horison Forbis, Cilegon
Horizon (various)
Hotel Grandhika
Hyatt Regency Yogyakarta
Ibis Samarinda & Various
Ibis Style Bandung City Centre
Ibis Style Medan
Inaya Labuan Bajo
Intercontinental Hotels (various)

INDONESIA

JHL Solitaire Hotel
Jimbaran Bay Beach
JW Marriot Hotel Surabaya
JW Marriot Jakarta & Various
Kempinski Grand Indonesia
Komaneka Group
Kupu-Kupu Barong
Kyriad Sorong
Le Grandeur (various)
Le Meridien Bali
Legian Beach Hotel, Bali
Luxury Collection
Mandarin Oriental Jakarta
Mason Pine Hotel Bandung
Maya Sanur Bali
Melia Bali
Menara Peninsula Jakarta
Mercure Batavia & Various
Millennium Hotel Jakarta
Montigo Resort, Batam
Mulia Hotel Bali & Various
Natra Bintang, a Tribute Resort
Nihiwatu Villa Sumba
Nirwana Resort Bintan
Novotel (various)
Novotel Suites Yogyakarta
Novus Anyer
Oakwood Gold coast - Jakarta
Oakwood Premier Jakarta
Park Hyatt - Jakarta
Patra Jasa Cirebon
Patra Jasa Comfort Jakarta
Prada Hotel Bali
Pulau Bawah, Kepri
Pullman Jakarta & Vimala Hills
Puri asablanca, Jakarta
Ritz Carlton (various)
Sahid Hotels (various)
Santika Bukit Tinggi & Various
Sanur Beach Resort Bali
Sari Pan Pacific - Jakarta
Sense (various)
Sheraton Hotels (various)
Sofitel Seminyak, Bali & Others
Somerset Sudirman Hill
Swiss Belhotel Gilingan Surakarta
Swiss Belhotel Serpong
Swissbel Solo & Various
Tejaprana Ubud
The Alana Sentul, Bogor
The Grand Mansion Menteng
The Katamama Bali
The Kayana / Santika Bali
The Oasis (various)
The Plaza Residence, Jakarta
The Ritz Carlton Bali - Nusa Dua
The Trans Resort Bali
Trans Hotel Renon - Bali
Tune Hotels (various)
W Hotel-Bali
Westin Resort Bali
Wyndham Jakabaring

JAPAN

Ango Hotels
Ascott Hotels
Busena Terrace Resort Hotel
Crowne Plaza, Sapporo
Fusaki Resort Village
Grand Prince Hotel Takanawa
Grandviro Hotel NARA "Wakura"
Ha-To-Ri Hotel
Honbetsu Onsen Grand Hotel
Hosino Resort
Hotel "Shikitei"
Hotel 1899
Hotel Otaki
Hotel Rosso Karuizawa
Intercontinental Yokohama
Irodori Koyo
Koraku Hotel

JAPAN

Kyoto "Rengetsu-so"
Kyoto Tower Hotel
Misawa Okuise Kanko Hotel
Moxy Osaka Honmachi
Seragaki Resort Hotel
Simosato Hotel
Sinagawa Prince Hotel
The Uza Terrace

KOREA

Amiga Hotel, Seoul
Cheju Lotte & Ramada Plaza
COEX Intercontinental Seoul
Courtyard Marriot Pangyo
Courtyard Marriot, Seoul
Dragon Lodge Hotel
Gold One Hotel & Suites, Jeju
Grand Intercontinental Seoul
Haeundae Grand Hotel Busan
Hanwha resort
Hyatt Andaz Gangnam
Hotel in 9 Seoul
Hyatt Jeju
Hyundai lahan Mokpo & Pohang
Imperial Palace Hotel, Seoul
Incheon Grand Sheraton
JW Marriot (Shinsegae central city)
Lotte city Hotel Mapo
Lotte Hotel Seoul & Various
Lotte Hotel World
Marchblue Pool Villa
Millennium Seoul Hilton Hotel
Park Hyatt Busan & Seoul
Ramada Hotels (Various)
Ramada Plaza Jeju
Ritz Carlton, Seoul
Sanghwawon
Seamarg Hotel
Seoul Dragon City Hotel
Seoul Millennium Hilton
Seoul Palace Hotel
Seoul Sheraton Palace
Seoul Stanford Hotel
Sheraton Songdu
Yeosoo Hidden Bay Hotel

LAOS

Amari Vang Vieng
Anoulackkhenlao Hotel
Apsara Hotel
Avani Luang Prabang
Azalea Park View Hotel
Azalea Parkview Hotel
Crown Plaza Vientiane
Elephant Crossing Vang Vieng
Family Boutique Hotel
La Folie Lodge
Lao Poet Hotel
Le Charme Vientiane Hotel
Le That Luang D'or by D Varee
Luang Prabang View Hotel
Maison Souvannaphoum Hotel
Parasol Blanc Hotel, Luang Prabang
Parasol Blanc Phasouk Hotel
Sabaidee Hotel
Sanctuary Luang Prabang Hotel
Sanctuary Nam Ngum Beach Resort
Silver Naga Vang Vie
Souphattra Serviced Apartments
SureStay Hotel by Best Western Vientiane
The Apsara Hotel
The Belle Rive Hotel Luang Prabang
The Elephant Crossing Hotel in Vang Vieng
Tmark Resort Vangvieng
ViengTara VangVieng Resort
Virilya Boutique Hotel

MALAYSIA

Acappella Suite Hotel
Alila Bangsar
Aloft Langkawi



It is our privilege to serve

THE FRENCH TOUCH

MALAYSIA

Ambassador Row
Ancasa Royale Pekan
Anggun Boutique Hotel KL
Ascott star residence
Banyan Tree KL
Berjaya Times Square KL
Best Western Ion Delemen
Best Western Premier Genting
Capri by Fraser JB
Citadines Cyberjaya
Citadines Uplands Kuching
Clans Georgetown Penang
Country Garden Forest City
Dash Box Cyberjaya
Dash Resort Langkawi
Double Tree KL & Melaka
Dynasty Hotel Miri
Eastern & Oriental Penang
Fairfield Marriott Bintulu
First World Genting Highland
Gayana Eco Resort
Golden Sand Beach, Penang
Grand Hyatt Kuala Lumpur
Grand Millennium Kuala Lumpur
Grand Palace Hotel KK
Hilton Garden Inn Kuala Lumpur
Hilton KL & PJ
Hilton Kota Kinabalu
Hotel Equatorial
Hotel Granada JB
Ibis Johor Bahru
Ibis Style KK
Impiana Hotel Senai
Impiana KLCC
Le Meridien Kuala Lumpur
Mandarin Oriental KL
Marriott Resort Putrajaya, Miri
Maxim Genting
Mercure Kuala Lumpur
Mines Philea resort
Mudzaffar Hotel Melaka
New World Hotel Petaling Jaya
Nikko Hotel
Novotel Taiping
One World Hotel
Park City Everly Miri
Parkroyal Hotels
Pullman KL & Kuching
Qliq Damansara
Ritz Carlton Langkawi
Riverside Majestic Kuching
Shangri-La Penang
Sheraton Four Point Kuching
Sheraton Kuala Lumpur
Sheraton Petaling Jaya
Sofitel KL
Sunway Georgetown
Sunway Resort Hotel & Spa
Swiss Garden Kuala Lumpur
The Danna Langkawi
The Everly Putrajaya
The Gardens Midvalley
The Saujana Hotel KL
Thistle Hotels
Tribeca Residence
Tune Hotels (Various)
Tune waterfront Sarawak
Wedgewood Residences KL
Tune Hotels (Various)
Tune waterfront Sarawak
Wedgewood Residences KL

MALDIVES

A.D.S Resorts
Addaran Club Bathala Resort
Addaran Club Rannalhi Resort
Addaran Huduranfushi Resort
Addaran Meedhupparu Resort
Addaran Prestige Vadho
Addaran Prestige Water Villas

MALDIVES

Banyan Tree
Centara Grand Island
Constance Moofushi
Dhonveli Beach & SPA Resort
Dusit Thani Maldives
Four Seasons
Hakura Club
Hulhule Island Hotel
Hurawalhi Island Resort
Hyatt's
Innahura
InterContinental Maldives
Jumeirah - Various
Jumeirah Vittaveli Maldives
JW Marriott Maldives
Kuramathi (Universal)
Kuredu
Le Meridien Thilamaafushi
Lohsfushi Island Resort
Lux Resorts & Spas
Moofushi Resorts
OBLU North Island
OBLU SELECT, Sangeli
OBLU X
OBLU, Helengeli
Outrigger Konotta Maldives Resort
Ozen by Atmosphere
Shangri-La
Six Senses Laamu
South Palm Hotel Maldives
Summer Island Maldives
The Residence Maldives
Vakarufalhi Island Resort
Valimendhoo
Velassaru Lily Hotel
Velassaru Resort
Velimandu

MAURITIUS

20 Degrees Sud Hotel
Anantara
Angsana Hotel
Beachcomber Dinarobin
Beachcomber Le Cannonniers
Beachcomber Le Mauricia
Beachcomber Le Paradis
Beachcomber Le Victoria Hotel
Beachcomber Shandrani
C Palmar Beach
Casuarina Resorts
Constance Belle Mare Plage
Constance Le Prince Maurice
Hennessy Hotel
Heritage Awali
Heritage Le Telfair
Hilton
Holiday Inn Airport Hotel
Hotel des 2 Mondes
Intercontinental
La Maison D'Ete
La Pirogue
Labourdonnais Hotel
Le Meridien,
Le Preskil Hotel
Le Sakoa
Le Suffren
Long Beach
LUX* Belle Mare
LUX* Le Grand Gaube
LUX* Le Morne
Manta Cove
Marina
Maritim
Maritim Crystal Beach
Merville Hotel
Outrigger Resorts
Radisson Blu
Royal Palm
Salt of Palmar by LUX*
Sea Point Boutique Hotel
Shangri-La's Le Touessrok

MAURITIUS

Shankara
Shanti Maurice
Sofitel Imperial
Sofitel So
Solana Beach
St Regis
Sugar Beach Hotel
Tamassa Resorts by LUX*
The Address Boutique Hotel
The Ravenala Resort & Spa
The Residence
The Sands Resorts
VLH Grand Baie
VLH Le Palmar
VLH Paul & Virginie
VLH Pointe aux Biches
VLH Tamarin Hotel
VLH Tamarina Golf & Spa (Villas)
Voila Hotel
WelKin Hospital
Westin
Zilwa Attitude Resort

MYAMMAR

Amara Resort, Ngapali
Amata Hotel Group
Asia Plaza Hotel (Yangon)
Aureum, Inle
Aureum, Ngapali
Ayarwaddy, Mandalay
Ayeyar River View, Bagan
Bagan Ayeyar Hotel
Bay of Bengal Resort, Ngwe Saung
Bay View Hotel, Ngapali
Blue Bird Hotel, Bagan
Chatrium Hotel
Dream Villa Hotel (Kalaw)
Eskala Hotels & Resorts
Espace Avenir Hotel
Famous Parami
Golden Hill Tower, Yangon
Grand Amara, Nay Pyi Taw
Grand Mercure Yangon
Grand Palace Hotel
Grand United Hotel
Heritage De Bagan
Hotel Amara, Nay Pyi Taw
Hotel Corolla
Hotel Mergui
Ibis Hotel, Yangon
Inya Lake Hotel (Yangon)
Jade Marina Ngapali
Jade Royal
Jasmine Palace Hotels
Kempinski Nay Pyi Taw
KMA Hotel Group
Ngapali Bay Villas & Resorts
Ngwe Saung Yacht Club & Resort
Novotel Inle Lake
Novotel Yangon, Max
Olympic Hotel
Pacific Hotel Yangon
Park Royal Hotel, Yangon
Pristine Lotus, Ngapali
Pullman Mandalay Mingalar
Savoy Hotel
Sedona Hotel
Shangri-La Residence
Sky Star Hotel (Yangon)
Sule Shangri-La Hotel
Summit Park View Hotel
The Amara Hotel, Nay Pyi Taw
The Grand Amara, Nay Pyi Taw
The Hotel Regency (Nyaung Oo)
The Strand Cruise
The Strand Hotel
Yamaman Hotel Yangon
Yangon Excelsior Hotel
Zealax Hotel & Residence by Eskala

NEPAL

Akama Hotel
Aloft Hotel
Ambassador Hotel Kathmandu
Annapurna View Sarangkot
Atithi Resort Hotel
Barahi Resort, Chitwan
Club Himalaya Nagarkot
Dalai-La Boutique Hotel
Fairfield Marriott Kathmandu
Fistail Lodge Hotel - Pokhara
Gokarna Forest Resort
Green Park Hotel Chitwan
Harrison Palace Hotel, Biratnagar
Himalayan Front Hotel, Pokhara
Hotel Country Villa, Nagarkot
Hotel Del Annapurna
Hotel Grand
Hotel Himalaya
Hotel Platinum
Hotel Shambala
Hotel Shangri-La Kathmandu
Hotel Shanker
Hotel Summit
Hotel Suramma, Lumbini
Hotel Tibet International
Hotel West Wood, Chitwan
Hotel Yak & Yeti
Hyatt Regency Kathmandu
Jagatpur Lodge by Annapurna
Kasara Jungle Resort
Kathmandu Guest House
Landmark Hotel Kathmandu
Landmark Pokhara Hotel
Le Himalaya
Marriot Hotel
Mayamanoar Hotel, Kathmandu
Meghauri Serai Jungle Safari
Moonlight Hotel, Kathmandu
Mount Glory Forest & SPA
Mount Kailash Resort, Pokhara
Nepali Ghar Hotel
Park Village Resort
Park Village Waterfront, Pokhara
Pokhara Grand Hotel
Radisson Hotel Kathmandu
Shahanshah International
Shangri-La Village Pokhara
Soaltee Crown Plaza
Soaltee Sidkhim Hotel
Summit Hotel
Temple Tree Hotel
The Dwarika's Hotel Kathmandu
The Everest Hotel
The Lake Side Hotel, Pokhara
Tigerland Safari Resort, Chitwan
Traditional Comfort, Kathmandu
Vivanta Kathmandu

NEW ZEALAND

Adina Hotel Auckland
Airedale Boutique Suites Auckland
Art Deco Masonic Hotel, Napier
Britomart Hotel Auckland
Chateau Marlborough Hotel, Blenheim
City Life Hotel Auckland
Cordis Hotel Auckland
Crowne Plaza Auckland
Crowne Plaza Hotel Christchurch
Crowne Plaza, Queenstown
Distinction Hotel Christchurch
Distinction Hotels
Double Tree by Hilton Karaka
Double Tree by Hilton, Christchurch
Ebb Dunedin
Fable Christchurch
Fable Dunedin
Fino Hotel & Suites, Christchurch
Fitzroy Hotel by Fable Auckland
Gibbston Valley Lodge Queenstown
Grand Mercure Auckland
Grand Windsor Hotel, Auckland



It is our privilege to serve

THE FRENCH TOUCH

NEW ZEALAND

Heritage Hotels & Resorts
Hermitage Hotel
Holiday Inn Express Auckland
Holiday Inn Express Queenstown
Holiday Inn Queenstown
Holiday Inn Remarkables Park Queenstown
Holiday Inn Rotorua
Hotel Debrett, Auckland
Intercontinental Hotel, Wellington
Kelvin Hotel Invercargill
Leroy Hotel Auckland
LQ Kawarau River Queenstown
Marlborough Lodge, Marlborough
Mercure Dunedin Leisure Lodge
Mercure Oakridge Resort, Wanaka
Mercure Queen Street Auckland
Millbrook Resort Queenstown
Millennium Hotel Rotorua
MSocial Auckland
Nesuto Stadium Auckland
Novotel Hotels NZ
Novotel Wellington
Oaks Wellington
Park Hyatt Auckland
Pavilions Hotel Christchurch
Pullman Rotorua
Quest Apartment Hotels NZ
Quest Tauranga
Ramada Newmarket
Ramada Wellington
Rendezvous Hotel Christchurch
Rydges Hotel, Auckland
Rydges Latimer Christchurch
Scenic Hotel Auckland
Sheraton 4 Points Auckland
Sky City Hotel Auckland
SO/ Auckland
Sofitel Queenstown
Sudima Christchurch Airport
Sudima Christchurch City Hotel
Sudima Hotel Auckland Airport
Sudima Hotel Auckland City
Sudima Hotel Rotorua
Sudima Queenstown Five Mile
Swiss-Bel Hotels
The Hotel Britomart Auckland
The Muse Christchurch
Voco Auckland
Wigram Hotel Christchurch
Wyndham Gardens Christchurch

PHILIPPINES

ABC Hotel Angeles
Alphaland @ Balesin Island
Ambassador Inn
Angeles Beach Club
Anvaya Hotel
Anya Hotels
Ascott Hotels
Astoria Palawan, Boracay, Manila
AYALA Group of Hotels
Baguio Country Club
Bayleaf Hotels
Bayview Park Hotel
Bellevue Bohol & Various
Bellevue Manila
Belmont
Best Western Oxford & Various
Boracay Haven
Boracay Tubi
Camp John Hay Hotel
Century Hotels
Citadines
City Garden / Grand Hotels
City Of Dream Manila - Crown Tower
City Of Dream Manila - Nobu & Hyatt
City of Dreams, Nuwa Tower

PHILIPPINES

SEDA Vertis North
Serenity Suites by Best Western
Shangri-La Boracay Resort and Spa
Shangri-La Edsa
Shangri-La Fort
Shangri-La Makati
Sheraton Manila
SM Hotels Tall Vista
Smallville/Diversions21
Sofitel Hotel Manila
Sofitel Manila
Solaire Hotel Manila
Solaire Resort and Casino
Somerset Hotel
St. Giles Hotel
St. Luke's Hospital
St. Marks Hotel
Stoltenberg Hotel and Casino
Taal Hotel
Tacloban Plaza
The District Boracay
The Henry Hotels
The Peninsula Manila
Thunderbird Hotel and Casino
Tiger Okada Manila
Tiger Resorts
Torre Lorenzo Group
Torre Venezia Suites
Travellers International - Marriot Hotel,
Tune Hotels - Various
Waterfront Lahug Hotel and Casino
Waterfront Mactan Hotel and Casino
Waterfront Pavilion Casino and Hotel
Westown Hotels
Westown MO2 Hotels
Widus Resort and Casino
Winford Hotel and Casino

QATAR

Amari Hotel, Qatar
Avenue Hotel Doha
Banana Island by Anantara
Crown Plaza Doha
Ezdan Palace Hotel
Fraser Suites West Bay Doha
Grand Hyatt Doha
Hilton DOHA
Hyatt Residences
Intercontinental Doha
M Gallery Hotel, Doha
Mandarin Oriental, Doha
Marsa Malaz Kempinski, The Pearl
Mercure Grand Hotel, Doha
Mondrian Doha
Movenpick Tower & Suites
Musherib Hotel
Oaks Al Najada
Plaza Inn, City Inn Hotel
Premier Inn Doha
Ramada Encore Doha
Retaj Al Rayyan
Simaisma Beach Resort
Souq Al Wakrah by Tivoli
The Boutique Hotel, Qatar
The Torch, Doha
Tivoli Al Najada Doha Hotel
Vichy Celestins Spa Hotel
Victoria Hotel
W Doha Hotel & Residences
Wyndham Grand Regency Doha

SAUDI ARABIA

Aiana, makkah
Aljoud Hotel Makkah
Artar Madina
Best Western Hotel-Riyadh
Cophorn by Millennium Riyadh
Courtyard Marriot Hotel - ABHA
Courtyard Marriot Hotel
Crown Plaza Hotel-Riyadh,
Crown Plaza Madinah

SAUDI ARABIA

Double Tree by Hilton
Hayyat regency
Holiday Inn Alkhubar
Holiday Inn Express Jumeriah
Holiday Inn Hotel, Riyadh
Hyatt Regency Hotel
Intercon Hotel, Al Khobar & Jubail
Intercontinental Dar Al Hijra Madinah
Millennium Hotel, Hail
Millennium Hotel, Riyadh
Novotel Riyadh Jizan
Park Inn Hotel-Dammam
Radisson Sas Hotel-DQ
Sharacco Marriot Hotel, Riyadh
Staybridge, Jeddah

SINGAPORE

30 Bencoolen
8 on Claymore Residence
Andaz Hotel Singapore
Aqueen hotel @ Hamilton
Aqueen Hotel @ Little india
Ascott Orchard
Ascott Raffles Place
Butternut Tree
Capella Singapore
Capri by Fraser China Square
Capri by Fraser, Changi
Citadines Balestier
Citadines Connect City Centre
Citadines Fusionopolis
Citadines Mount Sophia
Citadines Raffles Place
Citadines Rochor
Clover Hotels
Concorde Hotel
Connect @ Changi
Conrad Millennium
Cophorne Hotels
Costa Sands Resort & Hotel
Courtyard by Marriot
Creston suites by Aqueen
Crown Plaza Airport Hotel
Daulat Hotel
Davley House
Dusit Thani Laguna
Duxton Reserve
Fairmount Hotel
Farrer Park Hospital
Four Points by Sheraton
Four Seasons Hotel
Fragrance Hotels
Fraser Residences Orchard
Furama City & Furama Riverfront
Grand Hyatt
Grand Intercontinental
Grand Mercure Roxy
Grand Park City Hall
Hilton Garden Inn
Hilton Orchard
Hmlet Group
Holiday Inn Express Clark Quay
Holiday Inn Express Katong
Holiday Inn Express, Serangoon
Holiday Inn Orchard City Centre
Holiday Inn Singapore little India
Hotel Arianna
Hotel Boss
Hotel Grand Pacific
Hotel Indigo Katong
Hotel Jen Tanglin
Hotel MI
Hotel NuVe Element & Heritage
Hotel Soloha
Hotel Vagabond
IBIS Bencoolen & IBIS Novena
IBIS Stlye @ Macpherson
Innotel
InterContinental Singapore
Ji Hotel
JW Marriott

SINGAPORE

Kempinski Singapore
KESA House
Lanson Place
Lyf Farrer Park
Lyf Funan Singapore
Lyf One North
M Social Hotel
Mandarin Oriental
Marina Bay Sands
Marriot Tangs
Mercure Middle Road
Millennium Hotels
Miramar Hotel
Mondrian
Moon Hotel
Movenpick Sentosa
Naumi Hotel
Novotel & Mercure @ Stevens
Oakwood Premier OUE
Oasia Hotel & Oasia Residence
One Farrer Spa & Resort
Outpost Sentosa
Pan Pacific Suites Beach Road
Pan Pacific Suites Orchard
Parc Sovereign Hotel
Park Avenue Hotels
Park Regis
Parkroyal Hotels
Parkroyal Marina
Patina Hotel
Peninsula Excelsior
Porcelain Hotels
Premier Inn
Pullman Hotel
Pullman Orchard
Raffles Singapore
Regent Singapore
Rendezvous Orchard
Ritz Carlton Singapore
RWS Equarius & Hard Rock
RWS Festive & Hotel Michael
RWS Hotel Crockford
RWS Jurong Gateway Hotel
Shan Residence
Shangri-La Hotel
Sheraton Towers
Six Senses Duxton
Snow Hotel
Sofitel City Centre & SO
Sofitel Sentosa Resort & Spa
Somerset Bencoolen
Somerset Liang Court
St. Regis
Swissotel Merchant Court
Swissotel Stamford
The Barrack Sentosa
The Fullerton Bay
The Fullerton Hotel
The Warehouse Hotel
Traders Hotel
Travelodge
Traveltime
V Hotel Bencoolen & Lavender
Venue Hotels
Village Hotel Sentosa
Voco
W Hotel
Wanderlust Hotel by Oakwood
Westin
Wilby Residences
York Hotel
YOTEL Airport Hotel
YOTEL Singapore Orchard

SRI LANKA

Arie Lagoon Negombo
Adhitya Hotel
Ahalegala Lake Resort
Airport Garden Hotel
Alankuda Beach Hotel
Aliya Resorts & Spa



It is our privilege to serve

THE FRENCH TOUCH

SRI LANKA

Almond Trees (Pvt) Ltd
Amagi Lagoon Resorts & Spa
Amangalla Galle
Amanwella Tangalle
Amara Resort
Amaya Hills Kandy
Amaya Lake Dambulla
Ananthaya Hotels & Resorts
Angel Beach Hotel
Araliya Beach Resort & Spa Unawatuna
Araliya Green City Hotel
Araliya Green Hills Hotel
Araliya Red Nuwara Eliya
Arya Lagoon, Kalpitiya
Auro Resort, Tangalle
Ayurvedic Pavilion
Bandarawela Hotel
Barcelo Hotels & Resorts
Barym Beach Ayurveda Resort
Barymreef Ayurveda
Bentota Beach Hotel
Blue Oceanic
Browns Beach Hotel
Calamander Unawatuna Beach
Camelot Beach Hotel
Cantaloupe Hotels
Cape Weligama Resort
Ceilao Land (Pvt) Ltd
Centara Ceysand Resorts & Spa
Cerendib Hotels
Ceylon Continental Hotel
Ceylon Holiday Resort
Chaarya Resort & Spa
Chandrika Hotel
Cinnamon Bay & Hikka
Cinnamon Citadel & Blu
Cinnamon Grand & Lake
Cinnamon LakeSide
Cinnamon Lodge
Cinnamon Red & Village
Citrus Hikkaduwa
Citrus Waskaduwa
Clove Villa
Club Oceanic
Club Palm Garden
Club Waskaduwa Beach Resort & Spa
Colombo City Hotel
Colombo Court Yard
Coral Rock Hotel
Crown Hotels
Devon Hotel
Dickwella Resort
Dolphine Hotel PLC
Dumabara Hotels
Dutch Bay Resort
Earl's Regency -Kandy
Earl's Court Hotel
Eden Resort & Spa
Elephant Corridor Hotel
Eraeliya Villas & Gardens
Esala Hospitality
Fairway Group Hotels
Fortune Premier
Galadari Hotel
Galle Face Hotel
Gimanhala Hotel
Global Life Style Lanka
Grand Kandyan
Grand Turf Nuwara Eliya
Grand Udawalawwe
Heritance Ahungalla
Heritance Kandalama
Heritance Mahagedara
Hethersett Hotels
Hettigoda City Hotel
Hill Club
Hilton Colombo
Hilton Jike
Holiday Inn Colombo
Hotel Clarion
Hotel Hill Top

SRI LANKA

Hotel Sapphire
Hotel Topaz
Hunas Falls Hotel
Jetwing Ayurvedic Pavilion
Jetwing Beach Hotel
Jetwing Blue Oceanic
Jetwing Colombo Seven
Jetwing Hunas FallsHotel
Jetwing Kaduruketha
Jetwing Kurulubedda
Jetwing Lake
Jetwing Light House Hotel
Jetwing LightHouse Hotel & SPA
Jetwing Northgate
Jetwing Passikuddha
Jetwing River Bank (Pvt) Ltd
Jetwing Seashells & The Beach
Jetwing St.Andrew's Hotel
Jetwing Sunrise & Yal
Jetwing TropicalVillas
Jetwing Vil Uyana
Jungle Beach Resort
Kandyan Resort
Kantara Hotel
Kingfisher Leisure
Kingsbury Hotels
Kithala Resort
Koggala Beach Hotel
Kosgoda Beach Hotel
La Fortress
Lagoon Paradise Hotel
Lanka Princess
Lanka Super Corals Hotel
Le-Grand
Long Beach Hotel
Lucky Elephant
Maalu Maalu Resort & Spa
Mahaweli Beach Hotel, Kandy
Makara Resort
Manamperi Hotel
Mandara Rosen
Marine Drive Hotels
Marriott's
Mermaid Hotel
Michelle Beach Resort
Mirissa Bay Resort
Mosvold Villa
Mount Batten Bungalow
Mount Lavinia Hotel
Neptune Ayurvedic Village
Nilaveli Beach Hotel
Opulent River Face Hotel
OZO Hotels-AmariGroup
Palm Village Hotel
Paradise Road
Pearl Grand Hotel
Pegasus Reef Hotel
Pledge 3 Hotel
Ramada Hotel
Reef Edge
Region Country Club
Renuka Hotels
Riverina Hotel
Royal Palms Beach Hotel
Saman Villas
Santani Wellness Resort & Spa
Serena Villas Hotel
Settle Inn Tourist Lodge
Shangri-La
Shangri-La Hambantota
Sheraton Kosgoda Turtle Beach Resort
Shinagawa Resort
Siddhalepa Ayurveda Health Resort
Sigiriya Village
Sorrowa Resort & Spa
Stargazer Hotel
Sun & Fun Resort
Sun Tan Beach Resort
Taj Hotel Colombo
Taj Samudra Colombo
Tamarind Hill

SRI LANKA

Tangerine Beach Hotel
Taprobana Wadduwa
Taru Villas
Tataruga Hotel
Temple Tree Resort & Spa
Thalahenna Villas
Thaulla Resort
The Blue Water
The Deer Park Hotel
The Habitat by Asia Leisure
The Ocean Colombo
The Tea Factory
The Thewa Residency
Theme Resort & Spa
Tropical Villas, Uga Bay
Turyaa Kaluthara
Uga Escapes (Pvt) Ltd
Ulagalla Walawwa
Unawatuna Beach Hotel
Wathura Resort
Weligama Bay Marriot Resorts & Spa
Weligama Hotel

TAIWAN

Aloft Taipei
Ambassador Hotel, Hsinchu
Ambassador Hotel, Taipei
Brio Hotel
Carlton Hotel Taichung
Chateau Beach Resort
Chateau De Chine Hualien
Chateau De Chine Taoyuan
Chuang-Tang Spring Hotel
Courtyard by Marriott Taipei DOWNTOWN
Courtyard Taipei
Crowne Plaza Tainan
Dolphin Bay Resort, Penghu
Eastern Villa, Taoyuan
Eclat Hotel, Taipei
Evergreen Keelung
Evergreen Palace Hotel, Chiayi
Evergreen Taipei
Fame Hall Garden Hotel
Farglory Hotel
Fleur de Chine
Fullon Hotel Fulong
Fullon Hotel Hualien
Fullon Hotel Kenting
Fullon Hotel Linkou
Fullon Hotel Taoyuan
Gloria Manor
Gloria Prince Taipei
Golden Paddy
Golden Tulip RS Boutique
Grand Hyatt Taipei
Grand Victoria Taipei
H Resort
Holiday Inn Express, Chiayi
Holiday Inn Express, Taichung
Holiday inn Tainan
Hotel Cozzi
Hotel Indigo Taipei North
Hotel Royal, Chiao Hsi Spa
Hotel Royal-Nikko Taipei
Hotel Sense
Hotel Valletta
Hoya Resort Hotel, Wuling
Humble House Taipei
Jasper villa, Banqiao
Jia-Jia West Market Hotel
JJ-W Hotel, Tainan
Kuva Chateau Taoyuan
Lakeshore Hotels
Lin Hotel
Lurline House
Madison Taipei
Maison de Chine Jiaoxi , Jiaoxi
Monarch Skyline Taoyuan
MU Hotels
NK Hostel
Onsen Papawaga

TAIWAN

Pacific Palm Lake, Shihmen
Palau Royal Resort, Palau
Papawaqa Hotspring Hotel
Park 259
Park Hotel, Taipei
Parkview Hotel, Taipei & Hua Lien
Pause Landis Resort, Wu Lai
Fullon Hotel Taoyuan
Gloria Manor
Gloria Prince Taipei
Golden Paddy
Golden Tulip RS Boutique
Grand Hyatt Taipei
Grand Victoria Taipei
H Resort
Holiday Inn Express, Chiayi
Holiday Inn Express, Taichung
Holiday inn Tainan
Hotel Cozzi
Hotel Indigo Taipei North
Hotel Royal ,Chiao Hsi Spa
Hotel Royal-Nikko Taipei
Hotel Sense
Hotel Valletta
Hoya Resort Hotel, Wuling
Humble House Taipei
Jasper villa, Banqiao
Jia-Jia West Market Hotel
JJ-W Hotel, Tainan
Kuva Chateau Taoyuan
Lakeshore Hotels
Lin Hotel
Lurline House
Madison Taipei
Maison de Chine Jiaoxi , Jiaoxi
Monarch Skyline Taoyuan
MU Hotels
NK Hostel
Onsen Papawaga
Pacific Palm Lake, Shihmen
Palau Royal Resort, Palau
Papawaqa Hotspring Hotel
Park 259
Park Hotel, Taipei
Parkview Hotel, Taipei & Hua Lien
Pause Landis Resort, Wu Lai

THAILAND

Aloft Hotel Bangkok
Amanpuri, Phuket
Amara Hotel Bangkok
Amari (Various)
Anantara (Various)
Ascott Sathorn, Bangkok
Avani (Various)
Away Chiang Mai Thapae Resort
Banyan Tree, Phuket
Carlton Sukhumvit, Bangkok
Centara Grand Hotels
Chatrium Residence, Bangkok
Chaweng Regent Beach Resort Samui
ClubMed, Krabi
Conrad Hotel, Samui
Courtyard by Marriott Bangkok
Crest , Phuket
Crown Plaza Lumpini
Diamond Cliff, Phuket
Double Tree by Hilton, Bangkok
Dusit (Various)
Emporium Suites, Bangkok
Evergreen Laurel, Bangkok
Four Points Sheraton, Bangkok
Four Points Sheraton, Phuket
Grand Hyatt Erawan
Grand West Sand , Phuket
Hard Rock Pattaya
Hilton Hotels (Various)
Holiday Inn (Various)
Hotel Clover, Phuket
Hotel Culture , Chiang Mai



It is our privilege to serve

THE FRENCH TOUCH

THAILAND

Hyatt Place, Bangkok
Hyatt Regency Hua Hin
Ibis Style Sukhumvit & Various
Indigo Bangkok
Intercontinental (Various)
Intercontinental Bangkok
JW Marriott Chalong , Phuket
JW Marriott, Bangkok
Katathani collection of resorts
Keemala, Phuket
Le Meridien (Various)
Lub D Hotel, Bangkok
Mandarin Oriental, Bangkok
Marriott (Various)
Melia Samui
Mercure Koh Chang, Trad
Modena, Burirum
Movenpick Ekkamai
Novotel Bangkok On Siam Square
Novotel Platinum Bangkok
Novotel Siam, Bangkok
Nusa My Ozone Khoyai
Paradise Beach Resort, Phuket
Phuket Beach Club, Bangkok
Pullman, Bangkok & Various
Rama gardens Hotel, Bangkok
Ramada Khaolak Phuket
Renaissance Pattaya
Royal Orchid Sheraton & Towers
Shama Lakeview Asoke Bangkok
Sheraton Hua Hin & Phuket
Six Senses Erawan Phuket
Sofitel Centara Grand Bangkok
Sofitel SO Bangkok
Somerset Lake Point, Bangkok
Supatra Resorts (Various)
Surf, Phuket
Tara Villa, Kanchanaburi
The Bay, Phuket
The Naka Phuket
The Seasons Pattaya , Chonburi
The Sukhothai, Bangkok
TR Rock Hill Hotel
Up Ekkamai Hotel, Bangkok
Veranda (Various)
Voque, Bangkok
Wyndham Grand Phuket
Wyndham Seapearl Phuket

UAE

Acacia Hotel, UAE
Ain Palace Hotel, UAE
Al Hamra Fort Hotel, UAE
Andaz Dubai The Palm
Ascott Hotel
Ayla Hotel Al Ain & Al Ain
Banyan Tree Al Wadi, UAE
Chi Hotel, Abu Dhabi
City Max Hotel Al Barsha
City Seasons, UAE
Citymax Dubai
Citymax Business Bay & Sharjha
Citymax Hotel Bur Dubai
Cophorne Hotel
Courtyard By Marriott
Cove Rotana Dubai
Crown Plaza Festival City Hotel
Crown Plaza Yas Island
Damac Prive
Double Tree Hilton Marjaan Island
Double Tree Hilton Residence RAK
Dukes Hotels Dubai
Dusit D2 Dubai
Emirates Palace
Fairmont Marina Residences
Fairmont Abu Dhabi
Hilton Al Hamra Beach & Golf Resort
IBS & MGM Hotel - Al Garhoud
Intercontinental Festival City,
JA Resorts Dubai

UAE

Jumeira Creek Hotel
Layia Plaza Hotel, Dubai
Le Meridien, Abu Dhabi
Lemon Tree Hotel Dubai
Mandreian Oriental
Marjaan Island Hotel & Resort RAK
Mercure Gold Hotel
Metropolitan Hotel, Dubai
Millennium, Abu Dhabi & Sharjah
Millennium Mont rose Apartment
Millennium Al Barsha Hotel
Millennium Atria Hotel
Movenpick Hotel Jumeirah Beach
Movenpick Hotel Media City
Movenpick Jumeirah Lake Towers
Naissk Hotel Dubai
Novotel Fujairah
Paramount Hotel
Premier inn Dubai
Pullman Dubai Mall of Emirates
Radisson Blu Hotel Ajman.
Radisson Blu Hotel Dubai Silicon Oasis
Radisson Blu Yas Island
Raffles Dubai
Ramada Hotel Dubai
Rotana Al Jaddaf
Sofitel Wafi
Studio M by Millennium
The Address Sheraton Town Dubai
The Address Fountain View
The Address Sky Views
The Oberoi Hotel Dubai
Vida Dubai Creek Harbour.
Vida Hills
Vida Residence Downtown

VIETNAM

Alibu Nha Trang
Alma Cam Ranh
Almanity Hoi An
Altara Suites
Amiana Nha Trang resort
An Nam Cam Ranh Resort
Anantara Mui Ne Resort & Spa
Anantara Hoi An & Qui Nhan
Angsana Laguna
Anoasis Beach Resort
Aqua Expeditions
Aristol International Hotel
Ariyana Smart Condotel, NT
Artnest Nha Trang
Aurai Camranh
Avani Hai Phong & Vung Tau
Avora Danang Hotel
Ba Na Hills Golf club
Banyan Tree
Best Western Phuquoc
BMC Qui Nh n
Boutique Cam Thanh Resort
Boutique Hoi An Resort
Camellia Hue Hotel
Capri by Fraser, HCMC
Caravelle Saigon Hotel
Charme Suite Saigon
Citadine Central Binh D ng
Citadines Pearl Hoian
Coco bay Danang
Costa Nha Trang
Crown Retreat Qui Nh n
Crowne Plaza Danang
Crowne Plaza Hanoi
D Qua Nha Trang
Daewoo Hanoi Hotel
Diamond Hotel & Resort, Nha Trang
DIC Star Nam Vinh Yen
Dream Plaza Hanoi
Dusit Princess Phu Quoc
Duyen Ha Cam Ranh Resort
Eastin Cam Ranh
Eastin Grand Hotel, HCMC
Eden Resort Phu Quoc

VIETNAM

Equatorial Ho Chi Minh City
Evason Ana Mandara Resorts & Spas
Felize En Vista
Festa Pearl Hoian
FLC Halong Bay
FLC Samson Golf & Resort
Four Point Sheraton, Danang
Fraser Suite Hanoi
Furama Resort Da Nang
Fusion MAIA Resort Danang
Fusion Maya Phu Quoc
Fusion Resort Nga Trang
Fusion Vung Tau
Glow Science Nha Trang
Golden Topaz Phu Quoc
Gonsala Nha Trang
Grand Mercure Danang
Green Heaven Hoi Ann
Hanoi Daewoo Hotel
Havana Nha Trang Hotel
Heritage Line
Hilton Da Nang
Hilton Opera
Hoiana Casino
Holiday Inn Saigon & Various
Hotel de l'opera
Hotel Dela Couple BY Magllery
Hotel Nikko Hanoi & Saigon
Hotel Novotel Danang
Ibis V ng Tàu & Various
Imperial Haiphong
Intercontinental Asiana Saigon
Intercontinental Danang
Intercontinental Hanoi WestLake
Intercontinental Nha Trang Hotel
Intercontinental Phu Quoc
JW Marriott Hotel Hanoi
K Sapa
Legend Saigon
Lemont Ba Vi Resort & spa
Liberty Central
Liberty Le Thanh Ton
Lotte Hotel Hanoi
Lotte Legend Saigon
M Gallery CÁT BÀ
M Gallery Yen Tu
Malibu Vung Tau Hotel
Marina Bay Vung Tau
Melia Danang & Hanoi
Melia Hoa Tram
Mercure Hanoi La Gare
Mercure VungTau
MGM Grand Ho Tram Beach
Mia Saigon
Movenpick Cam Ranh
Movenpick Hotel Hanoi
Movenpick Phuquoc
Movenpick V ng Tau
Muong Thanh Danang
Muong Thanh Nha Trang
Muong Thanh Phuquoc
Nam Nghi Phuquoc
Naman Retreat Resort, Danang
Narga Hotel
New World Saigon
Nikko Saigon Hotel
Novotel Danang & Hanoi
Oakwood Hanoi, Quan & Saigon
Oceanamie Ho Tram resort
Palm Garden Resort
Pan Pacific Hanoi
Panorama Eastin Grand Nha Trang
Paris Deli Danang Hotel
Park Hyatt Saigon
Park Royal Saigon
Peninsula Resort
Premier Han River
Premier Residence Halong
Premier Residence Phu Quoc
Premier Village Danang
Premier Village Phu Quoc

VIETNAM

Pullman Danang Beach Resort
Pullman Hanoi & Phuquoc
Pullman Saigon Centre
Pullman Vung Tau
Radisson Cam Ranh
Regent Phuquoc
Renaissance Saigon
Reveria Saigon Hotel
Royal Lotus QN - BIM
Royal Riverside Hoi An
Saigon Ha Long
Saigon Mai
Saigon Prince Hotel
Sam Tuyen Lam Golf, Dalat
Sapa Resort
Sau Mai Resort
Sedona Suite Saigon
Selectum Cam Ranh
Sheraton Hanoi Hotel
Sheraton Nha Trang Hotel & Spa
Sheraton Saigon
Sheraton Tamky Resort
Sherwood Suite Saigon
Sofitel Legend Metropole Hanoi
Sofitel Metropole Hanoi
Sofitel Saigon Plaza
Somerset (Various)
Somerset Chancellor Court HCMC
Somerset Grand Hanoi
Somerset H i Phòng Serviced Residence
Somerset HCMC Serviced residence
Somerset Hoa Binh
Somerset West Point Hanoi
Somerset Westlake
Sonasea Villas and Resort Phu Quoc
Starcity H Long Bay & Nga Trang
Sunrise Hoi An Beach Resort
Sunway Hotel Hanoi
Swandor Khanh Hoa
Swissbej Hotel
The Garden House Resort, PQ
The Hammock Hotel, Ben Thanh
The Landmark
The Reverie
The Royal International Gaming Hotel
The Shells Resort & SPA, Phu Quoc
Topas Ecolodge
Vanda Hotel, Danang
Victoria Hoi An Beach Resort & Spa
Vietnam SAA Hotels, HCMC
Vigro Nha Trang
Villa Song Saigon
Vincom Dong Hoi Quang Binh
Vincom Tay Ninh
Vincor Tran Phu - Thanh Hoa
Vinhomes Central Park
Vinhomes Golden River
Vinpearl Beachfront Nha Trang
Vinpearl Condotel Le Thanh Ton
Vinpearl Condotel Ngo Quyen DN
Vinpearl Da Nang Resort and Villas
Vinpearl Hue
Vinpearl Lang Son
Vinpearl Luxury Danang
Vinpearl Nam Hoi An
Vinpearl Nam Phuquoc
Vinpearl Phu Ly Ha Nam
Vinpearl Radisson Blu, PQ
Vinpearl Resort Nha Trang
Windsor Plaza Hotel Saigon
Wyndham Cam Ranh
Wyndham Ha Long
Wyndham Garden Hanoi
wyndham KN Cam Ranh (Lotus)
Zanier Phu yen
Zen Diamond Danang



Your JVD Distributor

JVD Companies

Europe & America

JVD sas, France
(Head office)

JVD Espana

JVD Americas

Asia

JVD Technologies Singapore
(Asia Pacific Regional Office)

JVD Technologies China