



# PRODUCT GUIDE

## 2023-2024



TRUST provides sustainable, solution-based innovative products to global commercial market. Provide efficient and comprehensive solutions from five aspects: waste management, cleaning products, material handling, catering services, and safety products. TRUST is worthy of your trust.

**No matter what you clean,  
we are the brand you can**



## Innovative Solutions

Our innovative products are designed to meet all of your needs and to enhance productivity in your workplace.



## Total Quality Control

Our products have been rigorously tested and performed with industry-leading durability.





## ENVIRONMENTAL SUSTAINABILITY

### A Green Future

At TRUST we strive to be environmentally friendly and stand by strict environmental standards and business practices. We align with environmental protection agencies and organizations in the pursuit of environmental sustainability. Our research and product innovation has led to the effective reduction of our carbon footprint in the manufacturing of commercial products.

Our vision is to provide comprehensive working solutions of high quality. By helping people in workplaces all around the world our products improve lives and help protect the environment. Environmental sustainability and environmental responsibility are at the core of our operations.

Creation of safe, sustainable products - At Trust we design, manufacture and market green products with environmentally friendly practices in place to protect, conserve, and sustain the world's natural resources.

Incorporating environmental principles into our partnerships – Our green vision leads us to collaborate in our business partnerships in seeking a green future.

We will continue to keep our clients up-to-date with our efforts and progress.



**8 | WASTE**

- 10 | All-purpose Containers
- 16 | Indoor Containers
- 28 | Recycling Containers
- 40 | Medical Waste Management
- 42 | Decoration Waste Containers
- 60 | Accessories



**64 | CLEANING**

- 68 | Cleaning Carts
- 78 | Cleaning Cart Combination
- 84 | Mopping Systems
- 92 | Wet Mops
- 100 | Wet Mop Handles
- 102 | Dust Mops
- 106 | Microfiber Cleaning System
- 112 | Brooms and Brushes
- 126 | Dust Pans
- 128 | Floor Squeegees
- 130 | Dusting Tools
- 132 | Auxiliary Cleaning Tools
- 140 | Washroom



**144 | MATERIAL HANDLING**

- 146 | Mobile Work Centers
- 152 | Platform Trucks
- 158 | Cube Trucks
- 160 | Tilt Trucks
- 164 | Utility Service Carts
- 168 | Cart Accessories
- 170 | Storage and Organization
- 176 | Container Tools



**180 | FOODSERVICE**

- 184 | Food Storages
- 218 | Insulated Products
- 230 | Transport
- 242 | Food Preparations
- 244 | Dishwashing and Storage
- 254 | Tote Boxes
- 256 | Youth Service
- 260 | Cleaning Tools

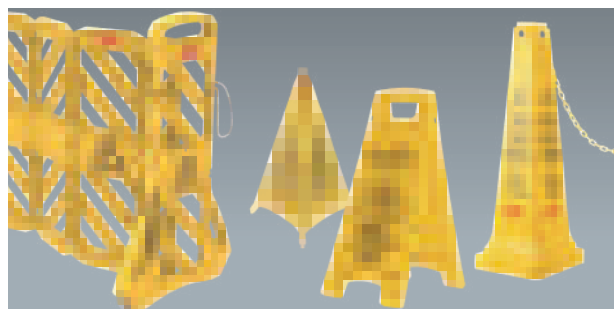

**266 | SAFETY**

- 268 | Safety Signs
- 270 | Safety Cones and Accessories

**6 | LEGEND**

**6 | COLOR GUIDE**





**7 | CERTIFICATIONS**



**274 | PRODUCT INDEX**

**317 | COMPONENT INDEX**



































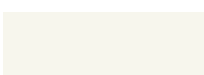



**327 | DISHWASING RACK GUIDE**

# LEGEND

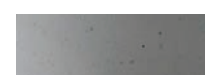
-  Assembly is required.
-  Hands free, reduce the risk of exposure to dirt.
-  Motorized with intelligent control system.
-  Color-coded cleaning system.  
Please select the proper color-coded equipment depending on the area to prevent cross-contamination.  
**Blue:** For general cleaning, such as office and lobby.  
**Yellow:** For general cleaning of the bathroom area.  
**Red:** For cleaning high cross-contamination areas, such as toilet and bathroom.  
**Green:** For cleaning food service facilities, such as diningroom, kitchen, and canteen.
-  UV absorber is added to extend the service life in outdoor applications.

-  **BPA free**  
Eastman Tritan copolyester does not contain the toxic chemical bisphenol-A (BPA) and its use can help to increase food safety.  
Studies have shown that Bisphenol-A is harmful to human health. Components used in plastics, such as bisphenol-A (BPA) are released from plastic products, and are known as endocrine-disrupting compounds (EDCs) owing to their ability to modulate the endocrine system.
-  **Cadmium free**  
Exposure to cadmium is known to be toxic, and is linked to an increased risk for cancer as well as a number of kidney and liver afflictions.
-  **Dishwasher safe**

# COLOR GUIDE

					
Amber AMBR	Ashtree ASH	Beige BEIG	Black BLA	Blue BLUE	Brown BRN
					
Brown Stone BSTONE	Clear CLR	Coral CORL	Crimson CR	Dark Brown DBRN	Dark Gray DGRAY
					
Empire Green EGRN	Golden Yellow GLD	Gray GRAY	Green GRN	Indigo Blue IND	Lacquer LAC
					
Light Beige LBEIG	Light Brown LBRN	Light Gray LGRAY	Light Platinum LPLAT	Light Red LRED	Metallic Silver MSILV
					
Natural NAT	Off White OWHT	Orange ORA	Platinum PLAT	Red RED	Reddish Brown RBRN
					
River Rock ROCK	Sage Green SGRN	Satin Stainless Steel SSS	Semi-transparent STRAN	Speckled Gray SGRAY	Stainless Steel SS
					
Titanium Gold TITA	Verdant Green VGRN	Walnut WAL	White WHT	Yellow YEL	

## CERTIFICATES



### ISO-international Organization for Standardization

ISO9001-2001 is an internationally recognized quality management system that provides:

1. Guidance for businesses that want to implement or improve quality systems within their business.
2. Benchmarks that customers can use to evaluate an organization's quality system.
3. Represents a commitment to continuous value improvement.

ISO 14000 is a family of standards to plan, implement, inspect and review environment management and operation system to enhance the environment protection:

1. Promote the implementation of environmental management regulations and systems.
2. Promote the improvement of environmental management within the business.
3. Promote the harmonious development of environment and economy.



### ASTM Certification

ASTM F404 is the American Society for Testing and Materials' safety standard for evaluating a High Chair. TRUST youth seat has been approved in ASTM F404 testing.

ASTM F2285 is an American Society for Testing and Materials' safety performance specification that establishes performance requirements, test methods, and labeling requirements to minimize the hazards to children presented by Diaper Changing Tables for commercial use with children up to 22.7kg. TRUST baby changing station passed the ASTM F2285 testing.



### QS Certification

Quality Safety. TRUST has been granted a QS production license certificate.



### UL Certification

Underwriters Laboratory (UL) approved containers (1261/1262 /1263/1264) , up to UL94-2010 standard, while rated to be VO.



### FDA Certification

Under regulations administered by the U.S. Food and drug Administration(FDA), this product, as supplied by Eastman Chemical Company, many lawfully be used on the basis of 21 CFR 174.5(d)(5)as a component in the manufacture of repeated use food-contact articles as described in Food Contact Notification No.729. The finished food contact article containing this polymer is intended to contact all types of food at temperatures up to and including 100°C (for definitions of food types, refer to Tables 1 and 2 at website <http://www.fda.gov/Food/FodIngredientsPackaging/FoodContactSubstancesFCS/default.htm>). This formulation contains a proprietary additive which complies with the regulations for indirect food additives published by the U.S. Food and Drug Administration. In addition, the general provisions for indirect food additives in 21 CFR 174.5 are applicable to the use of this product.



### China Environmental Labeling

China Environmental Labeling Product Certification is the most authoritative certification of green products and environmental friendly products in China, to recognize the product quality and environmental performance and confirm that the products meet the national standards for environmental protection requirements on behalf of the government.



### HACCP Certification

Hazard Analysis and Critical Control Points is a systematic method using principles (Food Hygiene Practices) for analyzing food process and determining the possible chemical, physical, and biological hazards within that process that should prevent any unsafe food from leaving the process.



### NSF Certification

NSF (National Sanitation Foundation) is committed to standards development, product testing and certification services in the fields of public sanitation and security. It's a widely recognized leading global provider of public health and security certification.



### ISTA-international Safe Transit Association

TRUST has ISTA-certified laboratory for testing and certification of transport packaging.



### EU Certification

The EU issued directive 1935/2004 for substances in contact with food. The purpose of this directive is to ensure that materials and substances in contact with food directly or indirectly is safe to the consumers both in design and structure. The TRUST food storage box (3011/3012) has been proved safe by relevant EU tests.



### TÜV Certification

TÜV is a security authentication marks which Germany TÜV specially made for components products. It has been widely accepted in Germany and Europe. The purpose of safety standards is to prevent household electrical products, mechanical products, automobile products causing the danger personal injury and property damage during the using process.



### GS Certification

GS is the meaning of "German Geprüfte Sicherheit" (security certification).GS is recognized by European market as German security authentication marks, which based on German product safety(GPGS), and it is also a voluntary certification according to the European standard EN or German industrial standards DIN testing. TRUST multi-purpose draw ladder (6945/6946) passed GS testing.



**ALL-PURPOSE CONTAINERS**

- Thor® Containers and Accessories 10
- Thor® Rollout Containers 12

**INDOOR CONTAINERS**

- Svelte® Containers and Accessories 16
- Waste Classification Symbols 20
- Step-on Containers 21
- Rigid Liners for Step-On Containers 21
- Thor® Step-On Rollout Containers 24
- Hands-free Containers 25
- Soft Wastebaskets 26
- Unfire® Fire-resistant Wastebaskets 26
- Steel Mesh Bins 27
- Stainless Steel Trash Cans 27

**RECYCLING CONTAINERS**

- Thor® Recycling Containers and Accessories 29
- Svelte® Recycling Containers and Accessories 30

- Svelte® Waste Sorting System 31
- Waste Sorting System 35
- Thor® Waste Sorting System 36
- Rollout Recycling Bins 37
- Riston® Outdoor Recycling Containers 38
- Deskside Recycling Containers 38

**MEDICAL WASTE MANAGEMENT**

- Thor® Medical Containers 41
- Medical Step-on Containers 41

**DECORATIVE WASTE CONTAINERS**

- Rockface® Containers and Faceplates 43
- Steeledge® Containers 45
- Aluminum Trash Cans 47
- Open Trash Cans 48
- Step-on Containers 48
- Svelte® Stainless Steel Step-on Containers 50
- Neatace® Classic Trash Cans 51

- Riston® Decorative Containers 52
- Beucan® Outdoor Decorative Trash Cans 52
- Terminator® Cigarette Butt Buckets 54
- Steeledge® Cigarette Barrels 58

**ACCESSORIES**

- Thor® Accessories 60
- Carry Caddies 61
- Signboard Hooks 61
- Svelte® Accessories 62
- Waste Classification Symbols 63



## Perfect Waste Management System

We provide a highly efficient, low-cost waste management system. Our products are made of high quality material with a sturdy structure to prolong their life.

## Cost-Efficient

Our waste collection and transport solutions offer productivity gains - reducing the time taken for repetitive tasks.

## Sustainable Development

All our plastic containers are 100% recyclable.

## Multiple Solutions

We provide products of various sizes, colors and materials, designed to deliver practical waste solutions for diverse areas across the workplace.



# ALL-PURPOSE CONTAINERS



## THOR® ROUND CONTAINERS

### PRODUCT FEATURES:

1. All-plastic construction will not rust, chip, or peel; resists dents.
2. Ergonomic handles that are smooth and comfortable.
3. Reinforced rims increase strength and durability.
4. Comes with four trash liner grooves for easy attachment without the need to tie knots.
5. Four vent channels provide 50% less worker exertion when lifting a filled trash liner compared with a traditional container.
6. Bottom hand grips of 30 mm width assist in emptying.
7. Double-ribbed base increases stability and dragging capacity.



Ergonomic handles with trash liner grooves for easy attachment without the need to tie knots



Double-ribbed base with 30mm wide Bottom hand-grips



Reinforced rims increase strength and durability



Four vent channels provide 50% less worker exertion when lifting a filled trash liner compared with a traditional container

Model	Description	Dimensions	Capacity	Color	Pack
1009	THOR® Round Container	33.5 × 38.7cm	23L	BLUE, GRAY, WHT, YEL, GRN, RED, BRN	6
1011	THOR® Round Container	40.0 × 44.0cm	38L	BLUE, GRAY, WHT, YEL, GRN, RED, BRN	6
1010	THOR® Round Container	47.0 × 54.5cm	60L	BLUE, GRAY, WHT, YEL, GRN, RED	6
1012	THOR® Round Container	49.0 × 57.0cm	75L	BLUE, GRAY, WHT, YEL, GRN, RED, BLA, BRN	6
1013	THOR® Round Container	56.0 × 70.0cm	121L	BLUE, GRAY, WHT, YEL, GRN, RED, BLA, BRN, LGRAY	6
1014	THOR® Round Container	61.0 × 80.0cm	166L	BLUE, GRAY, WHT, YEL, GRN, RED, BLA	4
1015	THOR® Round Container	67.0 × 84.0cm	208L	BLUE, GRAY, WHT, YEL, GRN, RED, BLA	3

## THOR® FUNNEL TOPS

### PRODUCT FEATURES:

1. Made of tough and durable plastic.
2. Smooth surface for easy cleaning.
3. Hands-free funnel top, easier access for waste.

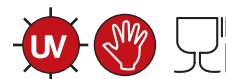

Model	Description	Dimensions	Capacity	Color	Pack
1621	THOR® Funnel Top for 1011	40.4 × 9.9cm	N/A	BLUE, GRAY, GRN	6
1622	THOR® Funnel Top for 1012	50.0 × 11.5cm	N/A	BLUE, GRAY, GRN	6
1623	THOR® Funnel Top for 1013	56.8 × 12.9cm	N/A	BLUE, GRAY, GRN	4



# THOR® ROUND TOPS

## PRODUCT FEATURES:

1. Choice of colored lids.
2. Strong, snap-on lids for secure, stable stacking.
3. 1633, 1634 made of structural web molded plastic to ensure higher durability and toughness.



Model	Description	Dimensions	Capacity	Color	Pack
1609	THOR® Lid for 1009	34.7 × 3.8cm	N/A	BLUE, GRAY, WHT, YEL, GRN, RED, BLA, BRN	6
1610	THOR® Lid for 1010	48.2 × 5.9cm	N/A	BLUE, GRAY, WHT, YEL, GRN, RED	6
1611	THOR® Lid for 1011	40.6 × 5.2cm	N/A	BLUE, GRAY, WHT, YEL, GRN, RED, BLA, BRN	6
1612	THOR® Lid for 1012	50.7 × 6.6cm	N/A	BLUE, GRAY, WHT, YEL, GRN, RED, BLA, BRN	6
1613	THOR® Lid for 1013	57.0 × 5.9cm	N/A	BLUE, GRAY, WHT, YEL, GRN, RED, BLA, BRN	6
1614	THOR® Lid for 1014	62.2 × 6.0cm	N/A	BLUE, GRAY, WHT, YEL, GRN, RED, BLA	4
1615	THOR® Lid for 1015	68.0 × 6.6cm	N/A	GRAY	3
1633	THOR® Round Top for 1013	57.6 × 31.1cm	N/A	GRAY, RED	1
1634	THOR® Round Top with an ashtray for 1013	57.6 × 31.1cm	N/A	GRAY, RED	1
1635	THOR® Bottle and Can Recycling Top for 1013	57.2 × 10.0cm	N/A	BLUE, GRN	6
1636	THOR® Paper Recycling Top for 1013	57.2 × 10.0cm	N/A	BLUE, GRN	6
1637	THOR® Single Stream Recycling Top for 1013	57.2 × 10.0cm	N/A	BLUE, GRN	6

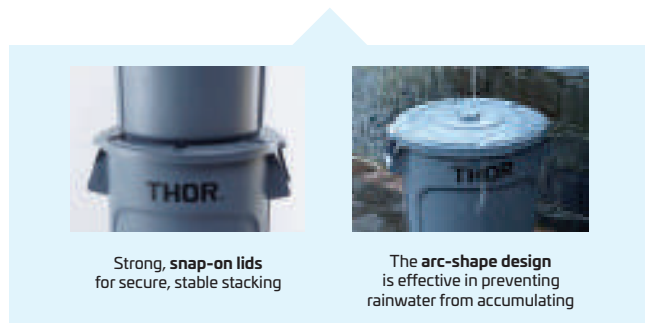

# THOR® DOLLIES

## PRODUCT FEATURES:

1. Easy mobility and maneuverability of heavy loads.
2. Swivel castors offer easy mobility.
3. Attach trash containers with ease.
4. Sturdy structural foam construction won't rust, dent, chip, or peel.
5. 1819 can easily transport 1015 and steel drums.



Model	Description	Dimensions	Capacity	Color	Pack
1811	THOR® Dolly for 1010/1012/1013/1014/1015	46.4 × 16.8cm	N/A	BLA	2
1813	THOR® Quiet Dolly for 1010/ 1012/1013/1014/1015	46.4 × 16.8cm	N/A	BLA	2
1818	THOR® Drum Dolly for 1010/1012/ 1013/1014/1015/1231/1233	114.3 × 51.4 × 20.3cm	N/A	BLA	1
1819	THOR® Universal Drum Dolly	61.9 × 18.1cm	N/A	BLA	2

## THOR® SQUARE CONTAINERS



### PRODUCT FEATURES:

1. Square shape offers up to 27% more capacity than round containers.
2. Ergonomic handles that are smooth and comfortable.
3. Reinforced rims add strength and durability.
4. Thick walls up to 4 mm add strength and durability.
5. Bottom hand grips of 30 mm width assist in emptying.
6. Tight fitting lids help protect the contents.
7. Square dollies are available to ensure easy mobility and maneuverability of heavy loads.



1231

1233



Equipped with **ergonomic handles** that are smooth and comfortable



**Bottom hand grips** of 30 mm width assist in emptying



**Tight fitting lids** help protect the contents. Lids allow for stable stacking to save space



**Square dollies** are available to ensure easy mobility and maneuverability of heavy loads

Model	Description	Dimensions	Capacity	Color	Pack
1231	THOR® Square Container	54.6 × 54.6 × 57.2cm	106L	GRAY, WHT, RED	6
1233	THOR® Square Container	59.7 × 59.7 × 73.0cm	150L	GRAY, WHT	4
TOPS					
1661	THOR® Lid for 1231	55.9 × 55.9 × 5.1cm	N/A	GRAY, WHT, RED	6
1663	THOR® Lid for 1233	61.0 × 61.0 × 5.1cm	N/A	GRAY, WHT	4

## THOR® ROLLOUT CONTAINERS



### PRODUCT FEATURES:

1. Heavy-duty 20cm wheels allow easy mobility, even over steps or curbstone.
2. Attached hinged lid fits securely; swings back and locks.
3. Molded-in axle retainer adds strength.
4. Inset wheel position helps prevent damage to walls and doorways.
5. 1025 is rotomolded, designed for holding a large volume of refuse. Its one-piece structure offers extraordinary strength and durability.



1021

1025

Model	Description	Dimensions	Capacity	Color	Pack
1021	THOR® Rollout Container	72.4 × 59.4 × 92.7cm	190L	BLUE, GRAY, YEL, GRN, RED	2
1025	THOR® Rollout Container	69.7 × 93.4 × 121.4cm	360L	GRAY, RED	1

## THOR® ROLLOUT CONTAINERS



### PRODUCT FEATURES:

1. Suitable for various commercial environments.
2. Heavy-duty 20cm wheels allow easy mobility, even over steps or curbstone.
3. Hinged lids close tightly and can be locked when fully lifted to prevent swinging during transport.
4. Inset wheel position helps prevent damage to walls and doorways.
5. Ergonomic handle, more flexible control.
6. Smooth surface for easy cleaning.
7. Reinforced rims add strength and durability.
8. 1033 and 1034 are rotomolded, designed for holding large volume of refuse. Its one-piece structure offers extraordinary strength and durability.



1031

1033

Model	Description	Dimensions	Capacity	Color	Pack
1031	THOR® Rollout Container	52.0 × 66.3 × 94.0cm	120L	BLUE, GRAY, YEL, GRN, RED, BLA	2
1032	THOR® Rollout Container	62.1 × 72.8 × 100.5cm	190L	BLUE, GRAY, YEL, GRN, RED, BLA	2
1033	THOR® Rollout Container	64.5 × 76.0 × 115.0cm	240L	BLUE, GRAY, YEL, GRN, RED, BLA	1
1034	THOR® Rollout Container	72.7 × 94.9 × 117.0cm	360L	BLUE, GRAY, YEL, GRN, RED, BLA	1

## THOR® ROLLOUT CONTAINERS WITH CASTORS



### PRODUCT FEATURES:

1. Suitable for various commercial environments.
2. Heavy-duty 20cm wheels allow easy mobility, even over steps or curbstone.
3. Hinged lids close tightly and can be locked when fully lifted to prevent swinging during transport.
4. Ergonomic handle, more flexible control.
5. Smooth surface for easy cleaning.
6. Reinforced rims add strength and durability.
7. 1043 and 1044 are rotomolded, designed for holding large volume of refuse. Its one-piece structure offers extraordinary strength and durability.
8. Front swivel castors with brake enable for enhanced maneuverability. Embedded castors designed to avoid damage caused by collisions with walls and doorways.



1041

1043

Model	Description	Dimensions	Capacity	Color	Pack
1041	THOR® Rollout Container with Castors	52.0 × 66.3 × 94.0cm	120L	BLUE, GRAY, YEL, GRN, RED, BLA	2
1042	THOR® Rollout Container with Castors	62.1 × 72.8 × 100.5cm	190L	BLUE, GRAY, YEL, GRN, RED, BLA	2
1043	THOR® Rollout Container with Castors	64.5 × 76.0 × 115.0cm	240L	BLUE, GRAY, YEL, GRN, RED, BLA	1
1044	THOR® Rollout Container with Castors	72.7 × 94.9 × 117.0cm	360L	BLUE, GRAY, YEL, GRN, RED, BLA	1



## THOR® STEP-ON ROLLOUT CONTAINERS

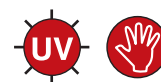

### PRODUCT FEATURES:

1. Suitable for various commercial environments.
2. Hands-free, improves work efficiency.
3. Heavy-duty 20cm wheels allow easy mobility, even over steps or curbstone.
4. Hinged lids close tightly and can be locked when fully lifted to prevent swinging during transport.
5. Inset wheel position helps prevent damage to walls and doorways.
6. Ergonomic handle, more flexible control.
7. Smooth surface for easy cleaning.
8. Reinforced rims add strength and durability.
9. Soft-close lid prevents noise effectively.
10. 1037 and 1038 are rotomolded, designed for holding large volume of refuse. Its one-piece structure offers extraordinary strength and durability.



1035



1037

Model	Description	Dimensions	Capacity	Color	Pack
1035	THOR® Step-On Rollout Container	52.0 × 66.3 × 94.0cm	120L	BLUE, GRAY, YEL, GRN, RED, BLA	1
1036	THOR® Step-On Rollout Container	62.1 × 72.8 × 100.5cm	190L	BLUE, GRAY, YEL, GRN, RED, BLA	1
1037	THOR® Step-On Rollout Container	64.5 × 76.0 × 115.0cm	240L	BLUE, GRAY, YEL, GRN, RED, BLA	1
1038	THOR® Step-On Rollout Container	72.7 × 94.9 × 117.0cm	360L	BLUE, GRAY, YEL, GRN, RED, BLA	1

## THOR® STEP-ON ROLLOUT CONTAINERS WITH CASTORS

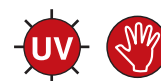

### PRODUCT FEATURES:

1. Suitable for various commercial environments.
2. Hands-free, improves work efficiency.
3. Heavy-duty 20cm wheels allow easy mobility, even over steps or curbstone.
4. Hinged lids close tightly and can be locked when fully lifted to prevent swinging during transport.
5. Ergonomic handle, more flexible control.
6. Smooth surface for easy cleaning.
7. Reinforced rims add strength and durability.
8. Soft-close lid prevents noise effectively.
9. 1047 and 1048 are rotomolded, designed for holding large volume of refuse. Its one-piece structure offers extraordinary strength and durability.
10. Front swivel castors with brake enable for enhanced maneuverability. Embedded castor design avoids damage caused by collisions with walls and doorways.



1045



1047

Model	Description	Dimensions	Capacity	Color	Pack
1045	THOR® Step-On Rollout Container with Castors	52.0 × 66.3 × 94.0cm	120L	BLUE, GRAY, YEL, GRN, RED, BLA	1
1046	THOR® Step-On Rollout Container with Castors	62.1 × 72.8 × 100.5cm	190L	BLUE, GRAY, YEL, GRN, RED, BLA	1
1047	THOR® Step-On Rollout Container with Castors	64.5 × 76.0 × 115.0cm	240L	BLUE, GRAY, YEL, GRN, RED, BLA	1
1048	THOR® Step-On Rollout Container with Castors	72.7 × 94.9 × 117.0cm	360L	BLUE, GRAY, YEL, GRN, RED, BLA	1

**THOR. CONTAINERS** can be configured with a variety of tops and dollies to suit any need.





## SVELTE® CONTAINERS



### PRODUCT FEATURES:

1. Our products are made of high quality material with a sturdy structure to prolong life.
2. The slim rectangle shape is space efficient and fits tight spaces.
3. Vent channels are designed for easy lifting of a filled trash liner with less exertion.
4. Ergonomic handles that are smooth and comfortable.
5. Comes with four trash liner grooves for easy attachment without the need to tie knots.
6. Bottom hand-holds assist in emptying.
7. Multiple interchangeable tops are available to suit various applications.
8. Custom imprinting available.



1215



1215/1216



Bottom hand-holds assist with emptying



Comes with four trash liner grooves for easy attachment without the need to tie knots



Optional Castor Set (1216), for easier movement

Model	Description	Dimensions	Capacity	Color	Pack
1215	SVELTE® Container	49.9 × 24.9 × 63.0cm	46L	BLUE, GRAY, YEL, GRN, RED, BLA, BRN, BEIG, LGRAY	4
1216	Castor Set for 1215	N/A	N/A	BLA	1



## SVELTE® TOPS

### PRODUCT FEATURES:

1. Interchangeable, color-coded tops promote waste separation.
2. Slotted blue top for paper.
3. Green and blue round-hole tops for glass bottles, glass jars, and metal cans.
4. Gray handle top for general refuse.
5. 1651 is sturdy and easy to cover. It is stackable and can be placed on its edge for easy storage.



1647



1648



1649



1650



1651



Svelte® Lockable Lid for 1215 ensures goods safety



Svelte® Lockable Lid for 1215 can be placed on the edge for easy storage

Model	Description	Dimensions	Capacity	Color	Pack
1647	SVELTE® Bottle and Can Recycling Top for 1215	45.2 × 25.8 × 6.2cm	N/A	BLUE, GRN	4
1648	SVELTE® Paper Recycling Top for 1215	45.2 × 25.8 × 6.2cm	N/A	BLUE	4
1649	SVELTE® Handle Top for 1215	45.2 × 25.8 × 6.2cm	N/A	LGRAY	4
1650	SVELTE® Swing Lid for 1215	45.4 × 25.9 × 8.0cm	N/A	BLUE, GRAY, GRN, BLA, BEIG	4
1651	SVELTE® Lockable Lid for 1215	48.0 × 26.0 × 5.5cm	N/A	BLUE, GRAY, GRN, BLA, BEIG	4



## SVELTE® CONTAINERS



### PRODUCT FEATURES:

1. Our products are made of high quality material and with a sturdy structure designed to prolong life.
2. The slim rectangle shape is optimized to fit tight spaces.
3. Vent channels are designed for easy lifting of a filled trash liner with less exertion.
4. Comes with ergonomic handles that are smooth and comfortable.
5. 1220 has an inset handle to save space.
6. Comes with four trash liner grooves for easy attachment without the need to tie knots.
7. Bottom hand-holds assist in emptying.
8. Multiple interchangeable tops are available to suit various applications.
9. Custom imprinting available.



Bottom hand-holds assist in emptying



Comes with four trash liner grooves for easy attachment without the need to tie knots



1220 has an inset handle to save space

Model	Description	Dimensions	Capacity	Color	Pack
1211	SVELTE® Container	57.0 × 27.2 × 63.2cm	60L	BLUE, GRAY, YEL, GRN, RED, BLA, BRN, BEIG, LGRAY	4
1213	SVELTE® Container	57.0 × 27.2 × 75.6cm	87L	BLUE, GRAY, YEL, GRN, RED, BLA, BRN, BEIG, LGRAY	4
1220	SVELTE® Container	51.3 × 27.2 × 75.6cm	87L	BLUE, GRAY, YEL, GRN, RED, BLA, BRN, BEIG, LGRAY	4

## SVELTE® TOPS



### PRODUCT FEATURES:

1. Interchangeable, color-coded tops promote waste separation.
2. Slotted blue top for paper.
3. Green and blue round-hole tops for glass bottles, glass jars, and metal cans.
4. Gray handle top for general refuse.



1641



1642



1643



1644



1645



1646

Model	Description	Dimensions	Capacity	Color	Pack
1641	SVELTE® Bottle and Can Recycling Top	52.3 × 28.8 × 6.7cm	N/A	BLUE, GRAY, GRN, RED, YEL, BRN, BLA	4
1642	SVELTE® Paper Recycling Top	52.3 × 28.8 × 6.7cm	N/A	BLUE, GRN, RED	4
1643	SVELTE® Handle Top	52.3 × 28.8 × 7.0cm	N/A	LGRAY	4
1644	SVELTE® Swing Lid	52.3 × 28.8 × 11.5cm	N/A	BLUE, GRAY, GRN, BLA, BEIG	4
1645	SVELTE® Connect Valve Style Lid	54.8 × 32.5 × 4.0cm	N/A	BLA	4
1646	SVELTE® Single Stream Recycling Top	52.3 × 28.8 × 6.7cm	N/A	GRN	4



## SVELTE® DOLLIES

### PRODUCT FEATURES:

1. Sturdy structural foam construction will not rust, dent or chip.
2. 7.5cm non-marking castors.
3. Easy mobility and maneuverability of heavy loads.
4. Multi-compartment dollies can easily move multiple containers and facilitate waste classification.



1814



1213/1815



Model	Description	Dimensions	Capacity	Color	Pack
1814	SVELTE® Dolly, for 1211/1212/1213/1214/1220/1221	51.6 × 29.0 × 26.0cm	N/A	BLA	2
1815	SVELTE® Double-compartment Dolly, for 1211/1212/1213/1214/1220/1221	58.2 × 51.7 × 24.0cm	N/A	BLA	1
1816	SVELTE® Tri-compartment Dolly, for 1211/1212/1213/1214/1220/1221	87.3 × 51.7 × 24.0cm	N/A	BLA	1
1817	SVELTE® Four-compartment Dolly, for 1211/1212/1213/1214/1220/1221	116.4 × 51.7 × 24.0cm	N/A	BLA	1

## WASTE CLASSIFICATION SYMBOLS



### PRODUCT FEATURES:

1. Helpful for waste classification.
2. Self-adhesive PVC sticker, easy to attach and scrub-resistant.

Model	Description	Dimensions	Pack
1940	"Recyclable Waste" Label	13.0 × 23.0cm	10
1941	"Soil" Label	13.0 × 23.0cm	10
1942	"Building Materials" Label	13.0 × 23.0cm	10
1943	"Garden Waste" Label	13.0 × 23.0cm	10
1944	"Food Waste" Label	13.0 × 23.0cm	10
1945	"Paint" Label	13.0 × 23.0cm	10
1946	"Household and Garden Chemicals" Label	13.0 × 23.0cm	10
1947	"Mixed Paper and Card" Label	13.0 × 23.0cm	10
1948	"Plastics" Label	13.0 × 23.0cm	10
1949	"Mixed Textiles and Clothes" Label	13.0 × 23.0cm	10
1950	"Mixed Glass" Label	13.0 × 23.0cm	10
1951	"Metal" Label	13.0 × 23.0cm	10
1952	"Batteries" Label	13.0 × 23.0cm	10



Helpful for waste classification and management.



## STEP-ON CONTAINERS

### PRODUCT FEATURES:

1. Tight-fitting lid helps contain odors and prevents insects such as house flies from entering.
2. Tough, puncture-resistant, all-plastic construction, resistant to damage or dents.
3. Quiet, heavy-duty pedal for hands-free hygienic use.
4. Soft-close lid prevents noise effectively.
5. Optional leak-proof rigid liners are available to contain liquid.



Soft-close lid prevents noise effectively

Model	Description	Dimensions	Capacity	Color	Pack
1251	Step-on Container	33.7 × 32.4 × 40.2cm	17L	BLUE, WHT, YEL, RED, BEIG	1
1252	Step-on Container	41.3 × 40.0 × 43.5cm	30L	BLUE, WHT, YEL, RED, BEIG	1
1253	Step-on Container	41.3 × 40.0 × 60.0cm	45L	BLUE, WHT, YEL, RED, BEIG	1
1254	Step-on Container	50.2 × 41.0 × 67.3cm	68L	BLUE, WHT, YEL, RED, BEIG	1
1255	Rollout Step-on Container	50.2 × 44.7 × 82.6cm	87L	BLUE, WHT, YEL, RED, BEIG	1

## RIGID LINERS FOR STEP-ON CONTAINERS

### PRODUCT FEATURES:

1. Helps prolong the life of your containers.
2. Durable plastic construction with smooth surfaces for easy cleaning.
3. Recessed hand grips are available for lifting and emptying.



Model	Description	Dimensions	Capacity	Color	Pack
1411	Rigid Liner for 1251	28.6 × 22.5 × 32.0cm	14L	GRAY	2
1412	Rigid Liner for 1252	36.5 × 29.8 × 33.7cm	27L	GRAY	2
1413	Rigid Liner for 1253	36.5 × 29.8 × 50.2cm	38L	GRAY	2
1414	Rigid Liner for 1254	45.7 × 31.1 × 55.9cm	56L	GRAY	4
1415	Rigid Liner for 1255	45.7 × 31.1 × 72.4cm	72L	GRAY	4

## SVELTE® STEP-ON CONTAINERS WITH FRONT PEDAL

### PRODUCT FEATURES:

1. Our products are made of high quality material and have a sturdy structure to prolong life.
2. Tough, puncture-resistant, all-plastic construction, resistant to damage or dents.
3. The slim rectangle shape is optimized to fit tight spaces.
4. Quiet, heavy-duty pedal for hands-free hygienic use.
5. Soft-close lid prevents noise effectively.
6. Hold liquid with standard rigid liner.
7. Castor for 1309 for easy movement.



Model	Description	Dimensions	Capacity	Color	Pack
1305	SVELTE® Step-on Container	37.7 × 23.0 × 39.9cm	15L	BLUE, GRAY, WHT, YEL, GRN, RED, BLA, BEIG	1
1306	SVELTE® Step-on Container	42.5 × 27.1 × 53.6cm	30L	BLUE, GRAY, WHT, YEL, GRN, RED, BLA, BEIG	1
1307	SVELTE® Step-on Container	45.6 × 29.2 × 71.9cm	50L	BLUE, GRAY, WHT, YEL, GRN, RED, BLA, BEIG	1
1308	SVELTE® Step-on Container	50.0 × 31.1 × 80.3cm	68L	BLUE, GRAY, WHT, YEL, GRN, RED, BLA, BEIG	1
1309	SVELTE® Step-on Container	57.0 × 35.3 × 82.6cm	90L	BLUE, GRAY, WHT, YEL, GRN, RED, BLA, BEIG	1

## RIGID LINERS FOR SVELTE® STEP-ON CONTAINERS WITH FRONT PEDAL

### PRODUCT FEATURES:

1. Helps prolong the life of your containers.
2. Durable plastic construction with smooth surfaces for easy cleaning.
3. Recessed hand grips are available for lifting and emptying.
4. Bottom hand-holds assist in emptying.



Model	Description	Dimensions	Capacity	Color	Pack
1425	Rigid Liner for 1305	32.5 × 18.9 × 32.4cm	12L	BLA	2
1426	Rigid Liner for 1306	37.6 × 23.1 × 46.1cm	26L	BLA	2
1427	Rigid Liner for 1307	40.2 × 24.9 × 64.6cm	44L	BLA	2
1428	Rigid Liner for 1308	45.1 × 25.9 × 71.8cm	58L	BLA	2
1429	Rigid Liner for 1309	51.6 × 30.0 × 74.3cm	75L	BLA	2



## SVELTE® STEP-ON CONTAINERS WITH SIDE PEDAL



### PRODUCT FEATURES:

1. Our products are made of high quality material and have a sturdy structure to prolong life.
2. Tough, puncture-resistant, all-plastic construction, resistant to damage or dents.
3. The slim rectangle shape is optimized to fit tight spaces.
4. Quiet, heavy-duty pedal for hands-free hygienic use.
5. Soft-close lid prevents noise effectively.
6. Hold liquid with standard rigid liner.



Model	Description	Dimensions	Capacity	Color	Pack
1301	SVELTE® Step-on Container	27.0 × 49.2 × 56.0cm	30L	BLUE, GRAY, WHT, YEL, GRN, RED, BLA, BEIG	1
1302	SVELTE® Step-on Container	30.7 × 50.7 × 72.1cm	50L	BLUE, GRAY, WHT, YEL, GRN, RED, BLA, BEIG	1
1303	SVELTE® Step-on Container	34.7 × 54.4 × 78.2cm	68L	BLUE, GRAY, WHT, YEL, GRN, RED, BLA, BEIG	1
1304	SVELTE® Step-on Container	37.9 × 60.1 × 81.2cm	90L	BLUE, GRAY, WHT, YEL, GRN, RED, BLA, BEIG	1

## RIGID LINERS FOR SVELTE® STEP-ON CONTAINERS WITH SIDE PEDAL

### PRODUCT FEATURES:

1. Helps prolong the life of your containers.
2. Durable plastic construction with smooth surfaces for easy cleaning.
3. Recessed hand grips are available for lifting and emptying.
4. Bottom hand-holds assist in emptying.



Model	Description	Dimensions	Capacity	Color	Pack
1421	Rigid Liner for 1301	42.0 × 19.0 × 46.9cm	30L	BLA	2
1422	Rigid Liner for 1302	45.1 × 24.3 × 64.0cm	50L	BLA	2
1423	Rigid Liner for 1303	48.2 × 27.9 × 70.0cm	68L	BLA	2
1424	Rigid Liner for 1304	54.0 × 31.2 × 72.0cm	90L	BLA	2



## THOR® STEP-ON ROLLOUT CONTAINERS



### PRODUCT FEATURES:

1. Suitable for various commercial environments.
2. Hands-free, operation improves work efficiency.
3. Heavy-duty 20cm wheels allow easy mobility, even over steps or curbstone.
4. Hinged lids close tightly and can be locked when fully lifted to prevent swinging during transport.
5. Non-protruding wheel position helps prevent damage to walls and doorways.
6. Ergonomic handle provides more flexible control.
7. Smooth surface for easy cleaning.
8. Reinforced rims add strength and durability.
9. Soft-close lid prevents noise effectively.
10. 1037 and 1038 are rotomolded, designed for holding large volume of refuse. Its one-piece structure offers extraordinary strength and durability.



1035

1037

Model	Description	Dimensions	Capacity	Color	Pack
1035	THOR® Step-On Rollout Container	52.0 × 66.3 × 94.0cm	120L	BLUE, GRAY, YEL, GRN, RED, BLA	1
1036	THOR® Step-On Rollout Container	62.1 × 72.8 × 100.5cm	190L	BLUE, GRAY, YEL, GRN, RED, BLA	1
1037	THOR® Step-On Rollout Container	64.5 × 76.0 × 115.0cm	240L	BLUE, GRAY, YEL, GRN, RED, BLA	1
1038	THOR® Step-On Rollout Container	72.7 × 94.9 × 117.0cm	360L	BLUE, GRAY, YEL, GRN, RED, BLA	1

## THOR® STEP-ON ROLLOUT CONTAINERS WITH CASTORS



### PRODUCT FEATURES:

1. Suitable for various commercial environments.
2. Hands-free, operation improves work efficiency.
3. Heavy-duty 20cm wheels allow easy mobility, even over steps or curbstone.
4. Hinged lids close tightly and can be locked when fully lifted to prevent swinging during transport.
5. Ergonomic handle provides more flexible control.
6. Smooth surface for easy cleaning.
7. Reinforced rims add strength and durability.
8. Soft-close lid prevents noise effectively.
9. 1047 and 1048 are rotomolded, designed for holding large volume of refuse. Its one-piece structure offers extraordinary strength and durability.
10. Front swivel castors with brake enable for enhanced maneuverability. Embedded castor are designed to avoid damage caused by collisions with walls and doorways.



1045

1047

Model	Description	Dimensions	Capacity	Color	Pack
1045	THOR® Step-On Rollout Container with Castors	52.0 × 66.3 × 94.0cm	120L	BLUE, GRAY, YEL, GRN, RED, BLA	1
1046	THOR® Step-On Rollout Container with Castors	62.1 × 72.8 × 100.5cm	190L	BLUE, GRAY, YEL, GRN, RED, BLA	1
1047	THOR® Step-On Rollout Container with Castors	64.5 × 76.0 × 115.0cm	240L	BLUE, GRAY, YEL, GRN, RED, BLA	1
1048	THOR® Step-On Rollout Container with Castors	72.7 × 94.9 × 117.0cm	360L	BLUE, GRAY, YEL, GRN, RED, BLA	1



# HANDS-FREE CONTAINERS

## PRODUCT FEATURES:

1. Suitable for hotel lobbies, washing rooms, malls, restaurants, and snack outlets, etc.
2. Semi-round and square containers are available to meet a variety of demands.
3. Durable and crack resistant, compatible with outdoor conditions.
4. Space-efficient and elegant half-round shape suitable for tight spaces.
5. Hands-free, drop-and-swing lid design provides easy access for refuse disposal. Closes quickly to contain odors and prevent the entry of insects, such as house flies.
6. Multiple interchangeable tops are available to suit various applications.



Model	Description	Dimensions	Capacity	Color	Pack
1223	Half-round Container	51.4 × 31.7 × 72.4cm	80L	GRAY, BEIG	4
1271	Square Container	39.4 × 39.4 × 78.5cm	87L	GRAY, BRN, BLA, BEIG, LGARY	4
1281	Square Container	36.6 × 36.6 × 71.0cm	75L	GRAY, BRN, BLA, BEIG	4
1282	Square Container	49.5 × 49.5 × 70.2cm	132L	GRAY, BEIG	4
1283	Square Container	49.5 × 49.5 × 87.0cm	190L	GRAY, BEIG	4
1284	Square Container	41.2 × 41.2 × 72.4cm	90L	GRAY	4

## TOPS

1653	Half-round Top for 1223	53.5 × 33.0 × 23.0cm	N/A	GRAY, BLA, BEIG	4
1681	Square Top for 1271	40.6 × 40.6 × 10.2cm	N/A	GRAY, BLA, BEIG	4
1682	Bottle/Tin Recycling Top for 1271	40.6 × 40.6 × 8.1cm	N/A	BLUE, GRN, RED	4
1683	Paper Recycling Top for 1271	40.6 × 40.6 × 8.1cm	N/A	BLUE, GRN	4
1684	Bottle/Tin Recycling Top for 1282	51.0 × 51.0 × 15.9cm	N/A	BLUE, GRN	4
1685	Paper Recycling Top for 1282	51.0 × 51.0 × 15.9cm	N/A	BLUE, GRN	4



## SOFT WASTEBASKETS



### PRODUCT FEATURES:

1. Slim design, cost efficient, fits tight spaces.
2. Rolled rims add strength and are easy to clean.
3. Round trims on all openings protect containers and reduces potential for injury.
4. Fits under a standard desk to allow convenient desk-side waste management.
5. Round swing tops allow easy access without reducing wastebasket capacity.
6. Hands-free top contributes to high waste management efficiency.



Optional label kit (1851) for effective garbage sorting



1672

1241

1242

1243

1244

1245

Model	Description	Dimensions	Capacity	Color	Pack
1241	Paper Recycling Container	26.9 × 18.5 × 29.7cm	3L	BLUE, GRAY, GRN, BLA	12
1242	Wastebasket, Small	28.9 × 21.0 × 30.8cm	13L	GRAY, BLA, BEIG	12
1243	Wastebasket, Medium	36.5 × 26.0 × 38.1cm	26L	BLUE, GRAY, GRN, BLA, BEIG	12
1244	Wastebasket, Large	38.7 × 27.9 × 50.5cm	39L	BLUE, GRAY, GRN, BLA, BEIG	12
1245	Wastebasket, Large	34.7 × 27.0 × 45.8cm	30L	BLUE, GRAY, GRN, BLA, BEIG	12

### TOPS

1672	Hands-free Top for 1242	30.0 × 22.0 × 12.8cm	N/A	GRAY, BLA, BEIG	6
1673	Hands-free Top for 1243	38.1 × 27.6 × 15.2cm	N/A	GRAY, BLA, BEIG	6
1674	Hands-free Top for 1244	40.6 × 29.5 × 17.8cm	N/A	GRAY, BLA, BEIG	6

## UNFIRE® FIRE-RESISTANT WASTEBASKETS



### PRODUCT FEATURES:

1. Fire-retardant materials add strength and prolong life.
2. Textured finish helps minimize appearance of surface scratches and is easy to clean.
3. Qualified with Underwriters Laboratories (UL) certification; fire within the bin is unable to melt the trash bin.
4. Choose from a variety of capacities and colors.



Fire-resistant



1261

1262

1263

1264

Model	Description	Dimensions	Capacity	Color	Pack
1261	UNFIRE® Fire-resistant Wastebasket	22.6 × 16.2 × 27.4cm	6.6L	BLA, BEIG	6
1262	UNFIRE® Fire-resistant Wastebasket	28.3 × 21.0 × 31.1cm	13L	GRAY, BLA, BEIG	6
1263	UNFIRE® Fire-resistant Wastebasket	36.8 × 26.7 × 38.9cm	26L	GRAY, BLA, BEIG	6
1264	UNFIRE® Fire-resistant Wastebasket	38.1 × 28.6 × 50.8cm	38L	BEIG	4

## STEEL MESH BINS

### PRODUCT FEATURES:

1. Designed for desk-side application.
2. Designed to be free of rolled rim wire to prevent hooking clothes.
3. Coated with epoxy paint.
4. Sturdy base made of premium steel.



1291

1292

1293

Model	Description	Dimensions	Capacity	Color	Pack
1291	Round Wastebasket	29.2 × 36.0cm	19L	BLA, MSILV	6
1292	Square Wastebasket	27.0 × 27.0 × 35.0cm	19L	MSILV	3
1293	Rectangular Wastebasket	42.3 × 25.4 × 37.0cm	28L	BLA	3

## STAINLESS STEEL TRASH CANS

### PRODUCT FEATURES:

1. Made of heavy-duty fireproof material, extremely durable.
2. Concealed trash bag design provides a clean and tidy appearance.
3. Unique base design protects floors.
4. For indoor use.



2401

2402

2403

Model	Description	Dimensions	Capacity	Color	Pack
2401	Stainless Steel Trash Can	23.0 × 27.0cm	7L	MSILV	1
2402	Stainless Steel Trash Can	23.5 × 27.0cm	7L	MSILV	1
2403	Stainless Steel Trash Can	20.5 × 30.0cm	8L	MSILV	1





## Perfect Waste Sorting and Recycling Solutions

For collecting and sorting various types of waste, our large capacity bins can meet a multitude of needs across different workplaces.

## Sturdy and Durable

Durable and crack-resistant, even under tough conditions both indoor and outdoor.

## Sorting And Recycling Categories Are Easily Defined

Recycling lids and bins of different Colors can facilitate the recycling of recyclable paper, metal, bottles and other recyclable materials, making classification and recycling more convenient and efficient.



## THOR® RECYCLING CONTAINERS

### PRODUCT FEATURES:

1. Easy to maneuver.
2. Can serve as central collection containers or shipping containers, reducing the amount of handling.
3. Couple with dollies to transport recyclable waste with ease and efficiency.
4. Dollies are sold separately.
5. All containers come standard with "Recycle" symbols.



Model	Description	Dimensions	Capacity	Color	Pack
1016	THOR® Round Recycling Container	49.0 × 57.0cm	75L	BLUE	6
1017	THOR® Round Recycling Container	56.0 × 70.0cm	121L	BLUE	6
1018	THOR® Round Recycling Container	61.0 × 80.0cm	166L	BLUE	4
1234	THOR® Square Recycling Container	59.7 × 59.7 × 73.0cm	150L	BLUE	4

## THOR® TOPS

### PRODUCT FEATURES:

1. Interchangeable, Color-coded tops promote waste separation.
2. Slotted top for paper.
3. Round-hole tops for glass bottles, glass jars, and metal cans.



Model	Description	Dimensions	Capacity	Color	Pack
1622	THOR® Funnel Top for 1016	50.0 × 11.5cm	N/A	BLUE, GRN	6
1623	THOR® Funnel Top for 1017	56.8 × 12.9cm	N/A	BLUE, GRN	4
1635	THOR® Bottle and Can Recycling Top for 1017	57.2 × 10.0cm	N/A	BLUE, GRN	6
1636	THOR® Paper Recycling Top for 1017	57.2 × 10.0cm	N/A	BLUE, GRN	6
1637	THOR® Single Stream Recycling Top for 1017	57.2 × 10.0cm	N/A	BLUE, GRN	6

## THOR® DOLLIES

### PRODUCT FEATURES:

1. Easy mobility and maneuverability of heavy loads.
2. Swivel castors offer easy mobility.
3. Attach trash containers with ease.
4. Sturdy structural foam construction won't rust, dent, chip, or peel.



Foot fixing position,  
easy loading and unloading



Model	Description	Dimensions	Capacity	Color	Pack
1811	THOR® Dolly for 1010/1012/1013/1014/1015	46.4 × 16.8cm	N/A	BLA	2
1812	THOR® Square Dolly for 1231/1233	43.8 × 15.9cm	N/A	BLA	2
1813	THOR® Quiet Dolly for 1010/ 1012/1013/1014/1015	46.4 × 16.8cm	N/A	BLA	2
1818	THOR® Drum Dolly for 1010/1012/ 1013/1014/1015/1231/1233	114.3 × 51.4 × 20.3cm	N/A	BLA	1

## SVELTE® RECYCLING CONTAINERS



### PRODUCT FEATURES:

1. Station containers serve as a convenient central collection site for multiple work stations.
2. All containers come standard with a "Recycle" symbol.
3. Optional dolly for 1212, 1214 and 1221. Refer to Page 20.



Model	Description	Dimensions	Capacity	Color	Pack
1212	SVELTE® Recycling Container	57.0 × 27.2 × 63.2cm	60L	BLUE, GRN	4
1214	SVELTE® Recycling Container	57.0 × 27.2 × 75.6cm	87L	BLUE, GRN	4
1217	SVELTE® Recycling Container	49.9 × 24.9 × 63.0cm	46L	BLUE, GRN	4
1221	SVELTE® Recycling Container	51.3 × 27.2 × 75.6cm	87L	BLUE, GRN	4
1224	Half-round Recycling Container	51.4 × 31.7 × 72.4cm	80L	BLUE	4

## SVELTE® TOPS



### PRODUCT FEATURES:

1. Interchangeable, Color-coded tops promote waste separation.
2. Slotted blue top for paper.
3. Green and blue round-hole tops for glass bottles, glass jars, and metal cans.
4. Gray handle top for general refuse.
5. 1218 collodion structure molding, sturdy and durable, with convenient and efficient fixed slots for garbage bags.

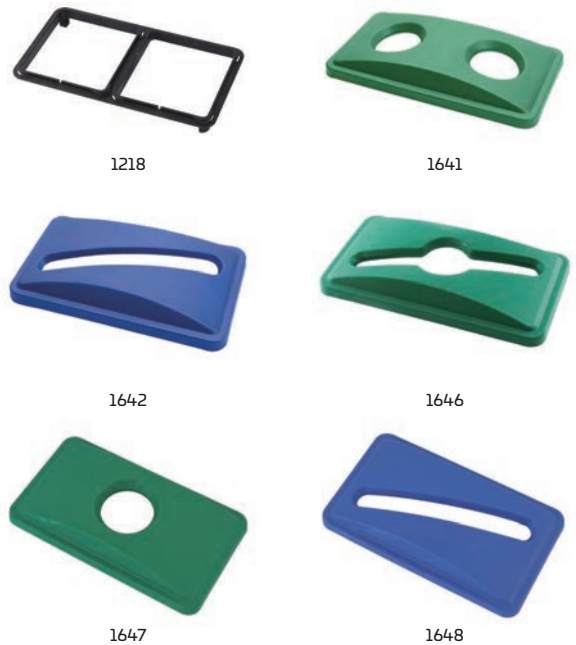

1641 can be used with the Classification collection lids (1219) to facilitate garbage classification management

Fixed slots for garbage bags on 1218 help with waste separation

Model	Description	Dimensions	Capacity	Color	Pack
1218	Garbage Classification Fixing Device for 1212/1214	50.7 × 27.2 × 5.0cm	N/A	BLA	1
1219	Classification Collection Lid for 1641	18.0 × 3.2cm	N/A	BLUE, YEL, GRN, RED	4
1641	SVELTE® Bottle and Can Recycling Top	52.3 × 28.8 × 6.7cm	N/A	BLUE, GRAY, GRN, RED, YEL, BRN, BLA	4
1642	SVELTE® Paper Recycling Top	52.3 × 28.8 × 6.7cm	N/A	BLUE, GRN, RED	4
1646	SVELTE® Single Stream Recycling Top	52.3 × 28.8 × 6.7cm	N/A	GRN	4
1647	SVELTE® Bottle and Can Recycling Top for 1217	45.2 × 25.8 × 6.2cm	N/A	BLUE, GRN	4
1648	SVELTE® Paper Recycling Top for 1217	45.2 × 25.8 × 6.2cm	N/A	BLUE	4

# SVELTE® WASTE SORTING SYSTEM



## PRODUCT FEATURES:

1. Comprehensive recycling solutions.
2. Fixed recycling container serves as waste recycling center for multiple workspaces.
3. Lids with different structures and Colors are available for easy waste sorting.
4. Capacities can accommodate larger sized recycling material.
5. Waste category labels are available for effective waste sorting.
6. Multiple combinations offer more effective waste sorting management.



Model	Description	Dimensions	Capacity	Color	Pack
1211	SVELTE® Container	57.0 × 27.2 × 63.2cm	60L	LGARY	4
1213	SVELTE® Container	57.0 × 27.2 × 75.6cm	87L	LGARY	4
1220	SVELTE® Container	51.3 × 27.2 × 75.6cm	87L	LGARY	4

## TOPS

Model	Description	Dimensions	Capacity	Color	Pack
1700	Lid for 1211/1213	52.0 × 28.2 × 11.8cm	N/A	LGARY	4
1701	Paper Recycling Top for 1700	41.5 × 22.6 × 1.6cm	N/A	BLUE, GRAY, YEL, GRN, RED, BLA, BRN	4
1702	Bottle and Can Recycling Top for 1700	41.5 × 22.6 × 1.6cm	N/A	BLUE, GRAY, YEL, GRN, RED, BLA, BRN	4
1703	Paper/Bottle Recycling Top for 1700	41.5 × 22.6 × 1.6cm	N/A	BLUE, GRAY, YEL, GRN, RED, BLA, BRN	4
1704	Enclosed Lid for 1700	41.5 × 22.6 × 1.6cm	N/A <td BLUE, GRAY, YEL, GRN, RED, BLA, BRN	4	

## WASTE SORTING LOGO

Model	Description	Dimensions	Capacity	Color	Pack
1842	Label Kit for 1700	39.0 × 7.0cm	N/A	N/A	1
1843	Label Kit for 1211/1213	16.8 × 29.7cm	N/A	N/A	1

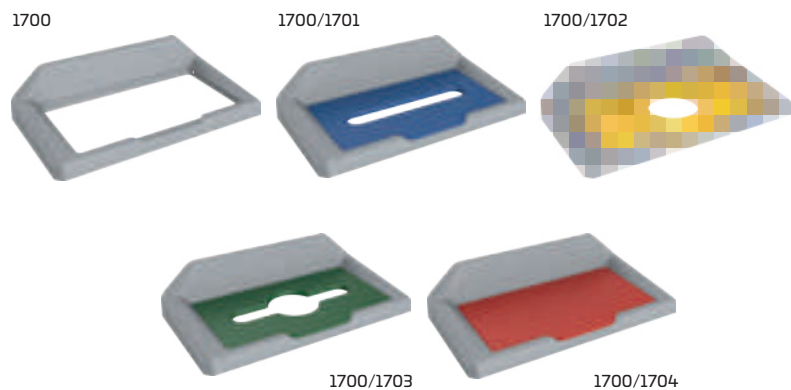

1842

1843

## SVELTE® WASTE SORTING SYSTEM



### PRODUCT FEATURES:

1. Comprehensive recycling solutions.
2. Fixed recycling container serves as waste recycling center for multiple workspaces.
3. Lids with different structures and Colors are available for easy waste sorting.
4. Capacities can accommodate larger sized recycling material.
5. Waste category labels are available for effective waste sorting.
6. Multiple combinations offer more effective waste sorting management.



Model	Description	Dimensions	Capacity	Color	Pack
1211	SVELTE® Container	57.0 × 27.2 × 63.2cm	60L	LGARY	4
1213	SVELTE® Container	57.0 × 27.2 × 75.6cm	87L	LGARY	4
1220	SVELTE® Container	51.3 × 27.2 × 75.6cm	87L	LGARY	4

### TOPS

Model	Description	Dimensions	Capacity	Color	Pack
1710	Lid for 1211/1213	28.2 × 52.0 × 14.3cm	N/A	LGARY	4
1711	Paper Recycling Top for 1710	21.6 × 46.6 × 2.0cm	N/A	BLUE, GRAY, YEL, GRN, RED, BLA, BRN	4
1712	Bottle and Can Recycling Top for 1710	21.6 × 46.6 × 2.0cm	N/A	BLUE, GRAY, YEL, GRN, RED, BLA, BRN	4
1713	Paper/Bottle Recycling Top for 1710	21.6 × 46.6 × 2.0cm	N/A	BLUE, GRAY, YEL, GRN, RED, BLA, BRN	4
1714	Enclosed Lid for 1710	21.6 × 46.6 × 2.0cm	N/A <td BLUE, GRAY, YEL, GRN, RED, BLA, BRN	4	

### WASTE SORTING LOGO

Model	Description	Dimensions	Capacity	Color	Pack
1844	Label Kit for 1710	19.9 × 8.5cm	N/A	N/A	1
1845	Label Kit for 1211/1213	13.0 × 23.0cm	N/A	N/A	1

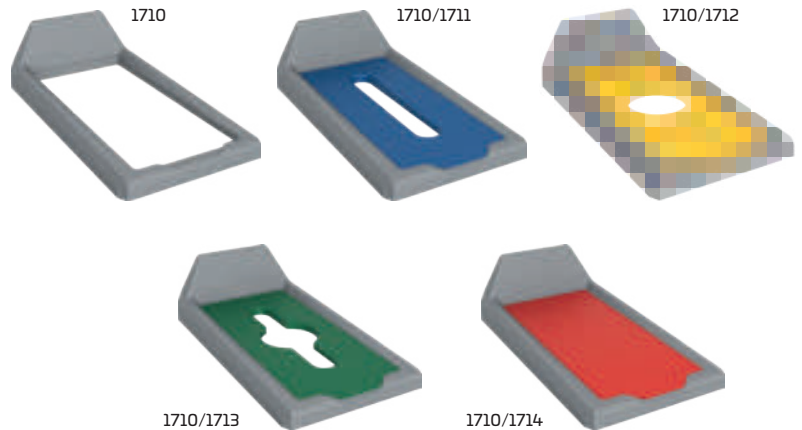

# SVELTE® WASTE SORTING SYSTEM



## PRODUCT FEATURES:

1. Comprehensive recycling solutions.
2. Fixed recycling container serves as waste recycling center for multiple workspaces.
3. Lids with different structures and Colors are available for easy waste sorting.
4. Capacities can accommodate larger sized recycling material.
5. Waste category labels are available for effective waste sorting.
6. Multiple combinations offer more effective waste sorting management.



1215

Model	Description	Dimensions	Capacity	Color	Pack
1215	SVELTE® Container	49.9 × 24.9 × 63.0cm	46L	LGARY	4

### TOPS

1730	Lid for 1215	45.7 × 26.0 × 11.8cm	N/A	LGARY	4
1731	Paper Recycling Top for 1730	35.2 × 20.4 × 1.6cm	N/A	BLUE, GRAY, YEL, GRN, RED, BLA, BRN	4
1732	Bottle and Can Recycling Top for 1730	35.2 × 20.4 × 1.6cm	N/A	BLUE, GRAY, YEL, GRN, RED, BLA, BRN	4
1733	Paper/Bottle Recycling Top for 1730	35.2 × 20.4 × 1.6cm	N/A	BLUE, GRAY, YEL, GRN, RED, BLA, BRN	4
1734	Enclosed Lid for 1730	35.2 × 20.4 × 1.6cm	N/A	BLUE, GRAY, YEL, GRN, RED, BLA, BRN	4

### WASTE SORTING LOGO

1847	Label Kit for 1730	36.2 × 8.0cm	N/A	N/A	1
1843	Label Kit for 1215	16.8 × 29.7cm	N/A	N/A	1



2 Stream



3 Stream



4 Stream

1730



1730/1731

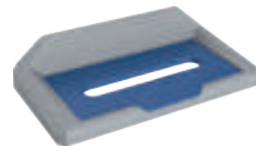

1730/1732

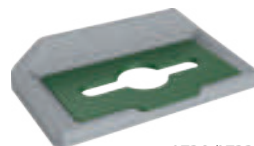
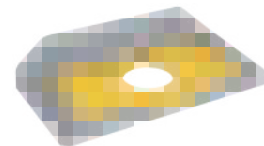

1730/1733

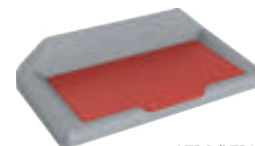

1730/1734

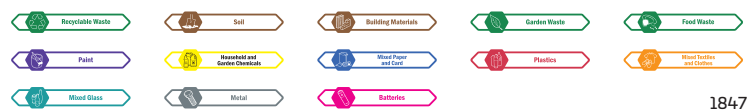

1847



1843

## SVELTE® WASTE SORTING SYSTEM



### PRODUCT FEATURES:

1. Comprehensive recycling solutions.
2. Fixed recycling container serves as waste recycling center for multiple workspaces.
3. Lids with different structures and Colors are available for easy waste sorting.
4. Capacities can accommodate larger sized recycling material.
5. Waste category labels are available for effective waste sorting.
6. Multiple combinations offer more effective waste sorting management.



1215

Model	Description	Dimensions	Capacity	Color	Pack
1215	SVELTE® Container	49.9 × 24.9 × 63.0cm	46L	LGARY	4
TOPS					
1740	Lid for 1215	26.0 × 45.7 × 14.3cm	N/A	LGARY	4
1741	Paper Recycling Top for 1740	19.4 × 40.3 × 2.0cm	N/A	BLUE, GRAY, YEL, GRN, RED, BLA, BRN	4
1742	Bottle and Can Recycling Top for 1740	19.4 × 40.3 × 2.0cm	N/A	BLUE, GRAY, YEL, GRN, RED, BLA, BRN	4
1743	Paper/Bottle Recycling Top for 1740	19.4 × 40.3 × 2.0cm	N/A	BLUE, GRAY, YEL, GRN, RED, BLA, BRN	4
1744	Enclosed Lid for 1740	19.4 × 40.3 × 2.0cm	N/A	BLUE, GRAY, YEL, GRN, RED, BLA, BRN	4
WASTE SORTING LOGO					
1848	Label Kit for 1740	17.7 × 8.0cm	N/A	N/A	1
1849	Label Kit for 1215	9.5 × 16.8cm	N/A	N/A	1



2 Stream

3 Stream

4 Stream

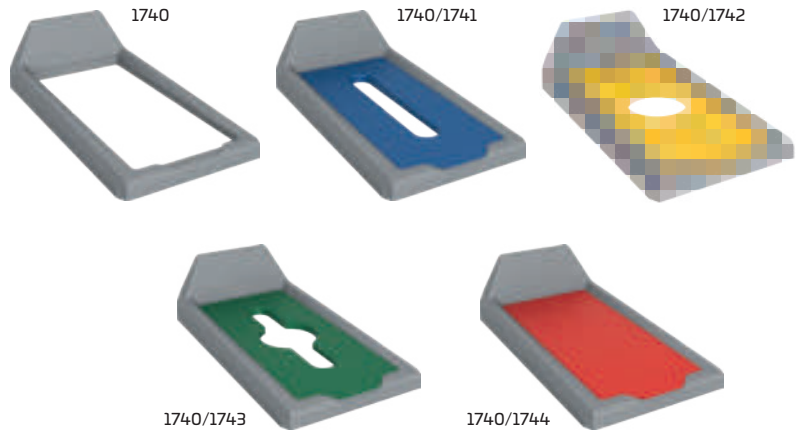

1848



1849



# WASTE SORTING SYSTEM

## PRODUCT FEATURES:

1. Comprehensive recycling solutions.
2. Fixed recycling container serves as waste recycling center for multiple workspaces.
3. Lids with different structures and Colors are available for easy waste sorting.
4. Waste category labels are available for effective waste sorting.
5. Multiple combinations offer more effective waste sorting management.



1271

Model	Description	Dimensions	Capacity	Color	Pack
1271	Square Container	39.4 × 39.4 × 78.5cm	87L	LGARY	4

### TOPS

1720	Top for 1271	40.2 × 40.2 × 12.8cm	N/A	LGARY	4
1721	Paper Recycling Top for 1720	31.8 × 32.5 × 2.1cm	N/A	BLUE, GRAY, YEL, GRN, RED, BLA, BRN	4
1722	Bottle and Can Recycling Top for 1720	31.8 × 32.5 × 2.1cm	N/A	BLUE, GRAY, YEL, GRN, RED, BLA, BRN	4
1723	Paper/Bottle Recycling Top for 1720	31.8 × 32.5 × 2.1cm	N/A	BLUE, GRAY, YEL, GRN, RED, BLA, BRN	4
1724	Large Waste Recycling Top for 1720	31.8 × 32.5 × 2.1cm	N/A	BLUE, GRAY, YEL, GRN, RED, BLA, BRN	4
1725	Enclosed Lid for 1720	31.8 × 34.3 × 2.1cm	N/A	BLUE, GRAY, YEL, GRN, RED, BLA, BRN	4

### WASTE SORTING LOGO

1846	Label Kit for 1720	28.4 × 7.0cm	N/A	N/A	1
1843	Label Kit for 1271	16.8 × 29.7cm	N/A	N/A	1



2 Stream

1720/1721

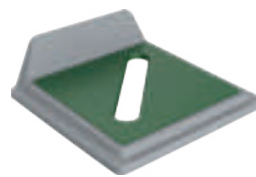

1720/1722

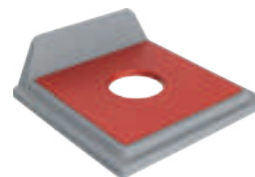

1720/1723

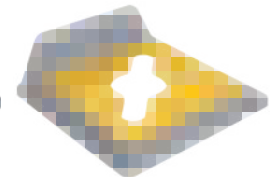

3 Stream

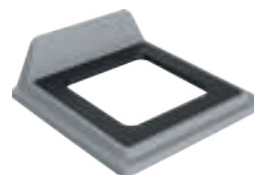

1720/1724

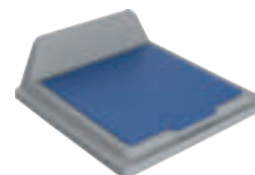

1720/1725



4 Stream



1846

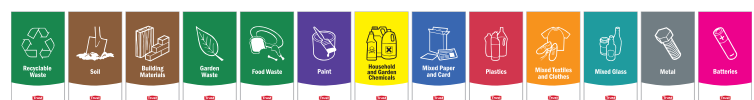

1843

## THOR® WASTE SORTING SYSTEM



### PRODUCT FEATURES:

1. Comprehensive recycling solutions.
2. Fixed recycling container serves as waste recycling center for multiple workspaces.
3. Lids with different structures and Colors are available for easy waste sorting.
4. Waste category labels are available for effective waste sorting.
5. Multiple combinations offer more effective waste sorting management.



1013

Model	Description	Dimensions	Capacity	Color	Pack
1013	THOR® Round Container	56.0 × 70.0cm	121L	LGARY	6

### TOPS

1750	Round Bins Lid for 1013	61.3 × 57.3 × 13.9cm	N/A	LGARY	6					
1751	Paper Recycling Top for 1750	39.8 × 34.5 × 2.2cm	N/A	BLUE, GRAY, YEL, GRN, RED, BLA, BRN	6					
1752	Bottle and Can Recycling Top for 1750	39.8 × 34.5 × 2.2cm	N/A	BLUE, GRAY, YEL, GRN, RED, BLA, BRN	6					
1753	Paper/Bottle Recycling Top for 1750	39.8 × 34.5 × 2.2cm	N/A	BLUE, GRAY, YEL, GRN, RED, BLA, BRN	6					
1754	Large Waste Recycling Top for 1750	39.8 × 34.5 × 2.2cm	N/A <td BLUE, GRAY, YEL, GRN, RED, BLA, BRN	6	1755	Enclosed Lid for 1750	39.8 × 33.6 × 3.0cm	N/A	BLUE, GRAY, YEL, GRN, RED, BLA, BRN	6
1755	Enclosed Lid for 1750	39.8 × 33.6 × 3.0cm	N/A	BLUE, GRAY, YEL, GRN, RED, BLA, BRN	6					

### WASTE SORTING LOGO

1839	Label Kit for 1750	21.7 × 7.5cm	N/A	N/A	1
1843	Label Kit for 1013	16.8 × 29.7cm	N/A	N/A	1



2 Stream



3 Stream



4 Stream



1750/1751

1750/1752

1750/1753



1750/1754



1750/1755



1839



1843

## ROLLOUT RECYCLING BINS, LARGE-CAPACITY



### PRODUCT FEATURES:

1. Can serve as central collection containers or shipping containers, reducing the amount of handling.
2. Rotomolded, industrial-grade, easy handling.
3. Smooth surfaces are easy to clean and resist corrosion.
4. The metal frame on 4724 and 4725 provides durable support.
5. 4523 angle design of front end assists with emptying.



Model	Description	Dimensions	Capacity	Color	Pack
4523	Tilt Truck, Standard Duty	183.2 × 85.1 × 111.4cm	800L	BLUE	1
4724	0.4 m <sup>3</sup> Cube Truck	117.0 × 84.0 × 86.0cm	400L	BLUE	2
4725	0.5 m <sup>3</sup> Cube Truck	125.5 × 92.0 × 94.0cm	500L	BLUE	2

## ROLLOUT RECYCLING CONTAINERS



### PRODUCT FEATURES:

1. Practical and efficient, designed for large amounts of trash.
2. Heavy-duty 20cm wheels afford easy mobility, even over steps or curbing.
3. Attached hinged lid fits securely; swings back and locks.
4. Molded-in axle retainer adds strength.
5. 1026 is rotomolded designed for large amounts of trash. Its one-piece structure offers extraordinary strength and durability.



Model	Description	Dimensions	Capacity	Color	Pack
1022	THOR® Rollout Recycling Trash Bin with Cover	72.4 × 59.4 × 92.7cm	190L	BLUE	2
1026	THOR® Rollout Recycling Bin, Rotomolded	69.7 × 93.4 × 121.4cm	360L	BLUE	1



## RISTON® OUTDOOR RECYCLING CONTAINERS



### PRODUCT FEATURES:

1. Large-capacity recycling container for any outdoor environment.
2. Attractive with a side-door design.
3. Durable molded construction with smooth surfaces, easy to clean.
4. Fixed device adds stability and safety for outdoor use.
5. Can be fixed to the ground with screws.
6. Built-in garbage bag holder, conveniently holds the garbage bag in place.
7. Optional hard inner bins, suitable for storing sharp and heavy waste.



2104



2105

Model	Description	Dimensions	Capacity	Color	Pack
2104	RISTON® Paper Recycling Container	62.9 × 64.0 × 107.0cm	190L	BLUE, GRN	1
2105	RISTON® Bottle Recycling Container	62.9 × 64.0 × 107.0cm	190L	BLUE, GRN	1
1282	Rigid Liner	49.5 × 49.5 × 70.2cm	132L	GRAY	4

## DEKSID RECYCLING CONTAINERS



### PRODUCT FEATURES:

1. An easy and effective way to recycle paper.
2. Designed to be used in systems with existing office containers and accessories.
3. Placed beside traditional wastebaskets to help recycle waste paper.

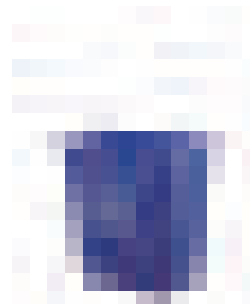

1246



1247



1249



1248



1241 can be used with optional label kit (1851) for effective garbage sorting management

Model	Description	Dimensions	Capacity	Color	Pack
1241	Side Bin Recycling Center	26.9 × 18.5 × 29.7cm	3L	BLUE, GRAY, GRN, BLA	12
1246	Deskside Recycling Container, Small	28.9 × 21.0 × 30.8cm	13L	BLUE, GRN	12
1247	Deskside Recycling Container, Medium	36.5 × 26.0 × 38.1cm	26L	BLUE, GRN	12
1248	Deskside Recycling Container, Large	38.7 × 27.9 × 50.5cm	39L	BLUE	12
1249	Deskside Recycling Container, Large	34.7 × 27.0 × 45.8cm	30L	BLUE	12
1851	Label Kit for 1241	14.3 × 2.2cm	N/A	N/A	1



# MEDICAL WASTE MANAGEMENT

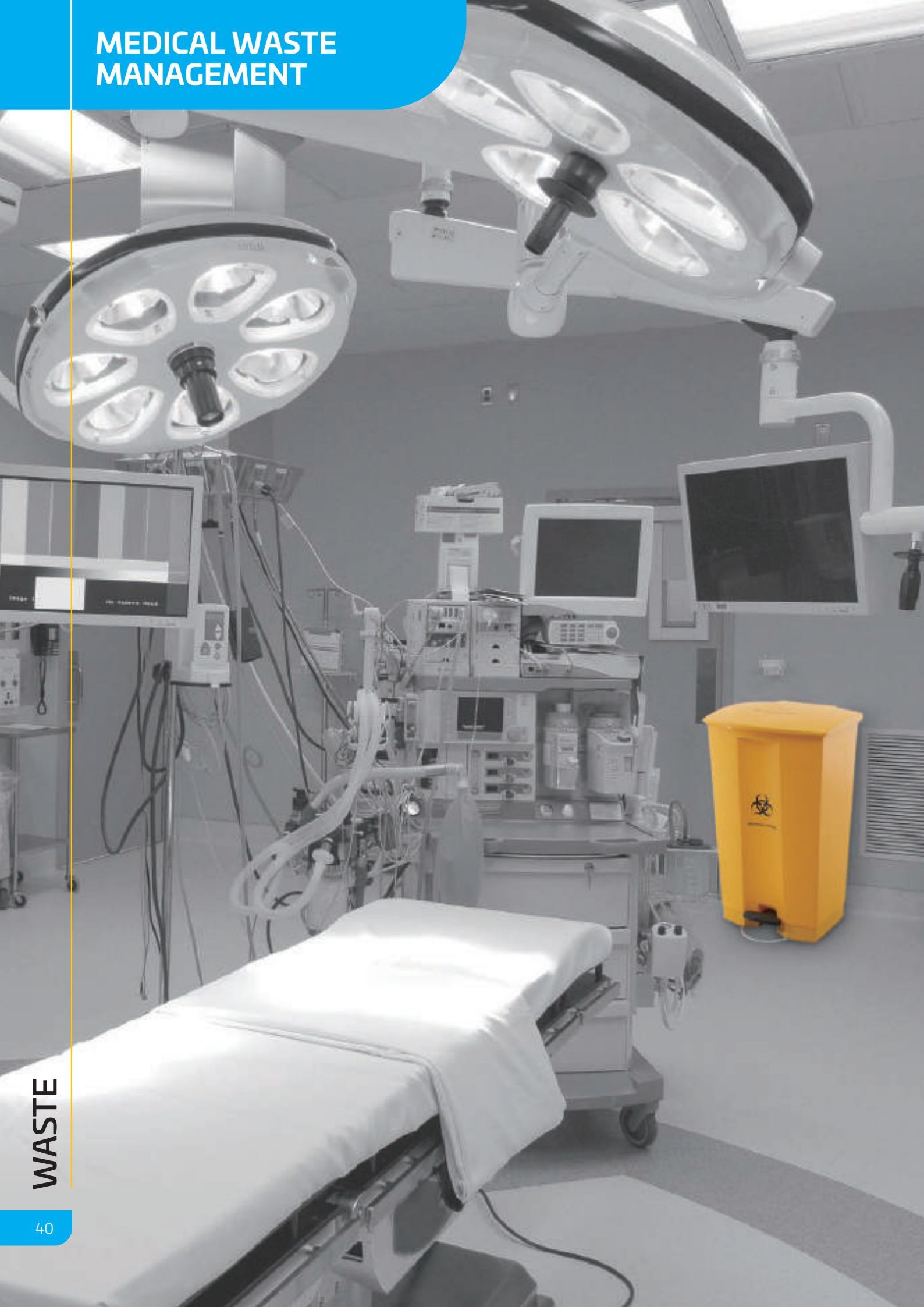

## THOR<sup>®</sup> MEDICAL CONTAINERS

### PRODUCT FEATURES:

1. Suitable for hospitals, clinics and other medical waste recycling applications.
2. Tough and durable all-plastic construction, reusable and puncture-resistant.
3. Seamless body ensures it is leakage-proof.
4. Smooth surfaces allow for easy cleaning and sterilizing.
5. Non-slip top allows for easy stacking.
6. Easy-grip handles assist with easy moving.
7. Hot stamped logos on yellow radiation-proof body are durable and non-fading.



1020



3013/3014

Model	Description	Dimensions	Capacity	Color	Pack
1019	Round Case, with a Top	49.0 × 57.0cm	75L	YEL, RED	6
1020	Round Case, with a Top	56.0 × 70.0cm	121L	YEL, RED	6
1235	Square Case, with a Top	54.6 × 54.6 × 57.8cm	106L	YEL, RED	6
1236	Square Case, with a Top	59.7 × 59.7 × 73.3cm	150L	YEL, RED	4
3013	Medical Waste Recycle Case	70.8 × 43.4 × 27.2cm	53L	YEL, RED	6
3014	Medical Waste Recycle Case	70.8 × 43.4 × 38.4cm	75L	YEL, RED	6

## MEDICAL STEP-ON CONTAINERS



### PRODUCT FEATURES:

1. Suitable for hospital wards, etc.
2. Smooth surfaces assist easy cleaning and sterilizing.
3. Equipped with a tightly fitted lid to contain odors and prevent the entry of insects, such as house flies.
4. Tough, puncture-resistant, all-plastic construction, resistant to damage or dents.
5. Quiet, heavy-duty pedal for hands-free hygienic use.
6. Soft-close lid prevents noise effectively.
7. Optional leak-proof rigid liners are available to contain liquid. Refer to Page 21.
8. Hot stamped logos on yellow radiation-proof body are durable and non-fading.



1256



1257



1258



1259

Model	Description	Dimensions	Capacity	Color	Pack
1250	Step-on Container	33.7 × 32.4 × 40.2cm	17L	YEL, RED	1
1256	Step-on Container	41.3 × 40.0 × 43.5cm	30L	YEL, RED	1
1257	Step-on Container	41.3 × 40.0 × 60.0cm	45L	YEL, RED	1
1258	Step-on Container	50.2 × 41.0 × 67.3cm	68L	YEL, RED	1
1259	Rollout Step-on Container	50.2 × 44.7 × 82.6cm	87L	YEL, RED	1

# DECORATIVE WASTE CONTAINERS



## Multiple Solutions

Our range includes products of various sizes, colors and materials and offers practical waste solutions for any area of the workplace.

## Sustainable Development

Good product design, sound recyclability and durability, and use of environmentally friendly materials define our efforts towards environmental sustainability.

## Smarter Decorative Receptacles

We provide customers with comprehensive, high efficiency and cost-effective waste solutions. Trust decorative receptacles offer a modern design, high quality surface treatment and long lasting performance both indoors and outdoors.



## ROCKFACE® CONTAINERS WITH ASHTRAY TOP

### PRODUCT FEATURES:

1. Suitable for the entrance to a building, hall or shopping center.
2. Comes with a wide opening for easy disposal of refuse.
3. The ashtray is a metal sand plate.
4. Optional faceplate available - sold separately.

## ROCKFACE® CONTAINERS WITH DRUM-TYPE TOP

### PRODUCT FEATURES:

1. Fit for applications in catering centers, theater halls or shopping centers.
2. Funnel-opening assists easy insertion of waste.
3. The hinged top can be tied up with a belt for easy access to contents.
4. Optional faceplate available - sold separately.

## ROCKFACE® CONTAINERS WITH FUNNEL-TOP

### PRODUCT FEATURES:

1. Fit for applications in catering centers, theater halls or shopping centers.
2. Funnel-opening assists easy insertion of waste.
3. The hinged top can be tied up with a belt for easy access to contents.
4. Optional faceplate available - sold separately.

## ROCKFACE® FACEPLATES

### PRODUCT FEATURES:

1. Clean and shiny faceplate for display of information and advertisement.
2. The dent-resistant faceplate supported by ABS is durable, resistant to tough weather conditions.



Model	Description	Dimensions	Capacity	Color	Pack
2011	ROCKFACE® Container with an Ashtray Top, and 1281 Liner	53.5 × 53.5 × 77.5cm	75L	BRN, LBRN	1
2012	ROCKFACE® Container with a Funnel-top, and 1281 Liner	53.5 × 53.5 × 77.5cm	75L	BRN, LBRN	1
2021	ROCKFACE® Container with an Ashtray Top, and 1282 Liner	66.0 × 66.0 × 77.5cm	132L	BRN, LBRN, BLA	1
2022	ROCKFACE® Container with a Funnel-top, and 1282 Liner	66.0 × 66.0 × 77.5cm	132L	BRN, LBRN, BLA	1
2023	ROCKFACE® Container with a Drum-type Top, and 1282 Liner	66.0 × 66.0 × 101.6cm	132L	BRN, LBRN, BLA	1
2024	ROCKFACE® Container with a Drum-type Ashtray Top, and 1282 Liner	66.0 × 66.0 × 101.6cm	132L	BRN, LBRN, BLA	1
2031	ROCKFACE® Container with a Drum-type Top, and 1283 Liner	66.0 × 66.0 × 118.0cm	190L	BRN, LBRN, BLA	1
2032	ROCKFACE® Container with a Drum-type Ashtray Top, and 1283 Liner	66.0 × 66.0 × 118.0cm	190L	BRN, LBRN, BLA	1

### FACEPLATES

2041	ROCKFACE® Concrete Faceplate, for 2011/2012	71.0 × 40.0 × 1.0cm	N/A	CORL, ROCK	4
2042	ROCKFACE® Concrete Faceplate, for 2021/2022/2023/2024	71.0 × 52.6 × 1.0cm	N/A	CORL, ROCK, BSTONE	4
2043	ROCKFACE® Concrete Faceplate, for 2031/2032	87.0 × 52.6 × 1.0cm	N/A	CORL, ROCK, BSTONE	4
2044	ROCKFACE® Ad Backing Faceplate, for 2031/2032	87.0 × 52.6 × 1.0cm	N/A	CLR	4

## ORDERING PROCEDURE

### Step 1: Select the container size and model

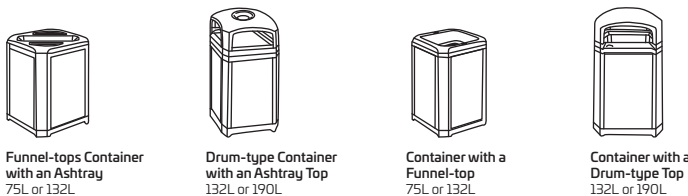

### Step 2: Select decorative faceplates (four plates for each container)

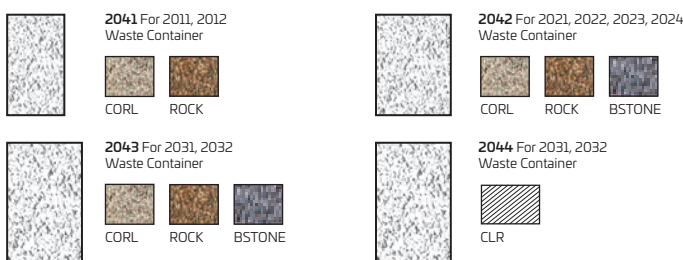

## ROCKFACE® DECORATIVE CONTAINERS



### PRODUCT FEATURES:

1. Ideal for the use in building entrances, lobbies and shopping malls.
2. Made of heavy-duty, hot-dip galvanized fireproof steel.
3. Weather-resistant top withstands harsh weather.
4. The top has openings on four sides for easy disposal of refuse.
5. An ashtray is attached.
6. Levelers facilitate use on uneven surfaces.
7. Includes a leak proof inner container made from galvanized steel.
8. User assembly is not required.



Convenient **hinged top** allows easy access to remove barrel



**Ashtray receptacle** isolates cigarette butts and prevents the chance of fire

Model	Description	Dimensions	Capacity	Color	Pack
2051	Container with a Drum-type Ashtray Top	25.4 × 62.5cm	12L	GRAY, BRN, EGRN	1
2052	Container with a Drum-type Top	25.4 × 61.0cm	12L	GRAY, BRN, EGRN	1
2061	Container with a Drum-type Ashtray Top	34.3 × 82.8cm	45L	GRAY, BRN, EGRN	1
2062	Container with a Drum-type Top	34.3 × 81.3cm	45L	GRAY, BRN, EGRN	1
2071	Container with a Drum-type Ashtray Top, Rod Openings	45.7 × 82.8cm	90L	GRAY, BRN, EGRN	1
2072	Container with a Drum-type Top, Rod Openings	45.7 × 81.3cm	90L	GRAY, BRN, EGRN	1
2081	Container with a Drum-type Ashtray Top	53.3 × 103.1cm	109L	GRAY, BRN, EGRN	1
2082	Container with a Drum-type Top	53.3 × 101.6cm	109L	GRAY, BRN, EGRN	1
2083	Container with a Flat-type Top	53.3 × 97.0cm	109L	GRAY, BRN, EGRN	1
2091	Container with a Drum-type Top	66.0 × 101.6cm	181L	GRAY, BRN, EGRN	1
2092	Container with a Drum-type Top with Side Door	66.0 × 101.6cm	181L	GRAY, BRN, EGRN	1
2093	Container with a Flat-type Top	66.0 × 97.0cm	181L	GRAY, BRN, EGRN	1



2091



2082



2061



2071



2072



2051



2052

# STEELEDGE® CONTAINERS



## PRODUCT FEATURES:

1. Ideal for use in hotels, airports, and train stations.
2. Ageless design, precisely manufactured - the perfect collection of sizes and shapes providing a fundamental solution.
3. Made of heavy-duty fireproof material, extreme durability.
4. Rubber rim effectively reduces damage to the product.
5. Unique base design protects floors.
6. Indoor use recommended.
7. Auto closing top and recessed handle facilitate moving and dumping.
8. Included a leak proof inner container made from galvanized steel.



Model	Description	Dimensions	Capacity	Color	Pack
2310	Ashtray/Trash, Mirror Chrome	25.4 × 68.6cm	13L	SS	1
2311	Ashtray/Trash, Satin Stainless Steel	25.4 × 68.6cm	13L	SSS	1
2312	Ashtray/Trash, Titanium Surface	25.4 × 68.6cm	13L	TITA	1
2320	Container Open-top, Mirror Chrome	38.1 × 71.1cm	56L	SS	1
2321	Container Open-top, Satin Stainless Steel	38.1 × 71.1cm	56L	SSS	1
2322	Container Open-top, Titanium Surface	38.1 × 71.1cm	56L	TITA	1
2330	Ashtray/Trash, Mirror Chrome	38.1 × 72.6cm	45L	SS	1
2331	Ashtray/Trash, Satin Stainless Steel	38.1 × 72.6cm	45L	SSS	1
2332	Ashtray/Trash, Titanium Surface	38.1 × 72.6cm	45L	TITA	1
2340	Container Flat-top, Mirror Chrome	38.1 × 71.1cm	45L	SS	1
2341	Container Flat-top, Satin Stainless Steel	38.1 × 71.1cm	45L	SSS	1
2342	Container Flat-top, Titanium Surface	38.1 × 71.1cm	45L	TITA	1
2350	Container Round-top, Mirror Chrome	38.1 × 76.0cm	45L	SS	1
2351	Container Round-top, Satin Stainless Steel	38.1 × 76.0cm	45L	SSS	1
2352	Container Round-top, Titanium Surface	38.1 × 76.0cm	45L	TITA	1
2360	Container Round-top, Mirror Chrome	38.1 × 91.4cm	56L	SS	1
2361	Container Round-top, Satin Stainless Steel	38.1 × 91.4cm	56L	SSS	1
2362	Container Round-top, Titanium Surface	38.1 × 91.4cm	56L	TITA	1
2370	Container Open-top, Mirror Chrome	25.4 × 38.1cm	18L	SS	1
2371	Container Open-top, Satin Stainless Steel	25.4 × 38.1cm	18L	SSS	1
2372	Container Open-top, Titanium Surface	25.4 × 38.1cm	18L	TITA	1



Satin Stainless Steel



Titanium Surface



## STEELEDGE® CONTAINERS



### PRODUCT FEATURES:

1. Premium containers for use in high-end environments.
2. Eternal design, chromium and copper polished coating, extreme durability to reduce maintenance costs, suitable for high profile display.
3. A perfect collection of sizes and shapes providing a comprehensive solution.
4. Made of heavy-duty fireproof material, extremely durable.
5. Rubber rim effectively reduces damage to the product.
6. Unique base design protects floors.
7. Only for indoor use.
8. Auto closing top and recessed handle facilitate moving and dumping.
9. Leak-proof galvanized steel inner container included.

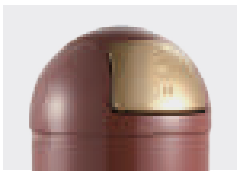

Dome lid shuts down automatically to prevent the bugs and odor

Model	Description	Dimensions	Capacity	Color	Pack
2314	Ashtray/Trash, Mirror Foot Circle	254 × 68.6cm	13L	GRAY, BLA	1
2315	Ashtray/Trash, Titanium Foot Circle	254 × 68.6cm	13L	CR, EGRN	1
2324	Container Open-top, Mirror Foot Circle	38.1 × 71.1cm	56L	GRAY, BLA	1
2325	Container Open-top, Titanium Foot Circle	38.1 × 71.1cm	56L	CR, EGRN	1
2334	Ashtray/Trash, Mirror Foot Circle	38.1 × 72.6cm	45L	GRAY, BLA	1
2335	Ashtray/Trash, Titanium Foot Circle	38.1 × 72.6cm	45L	CR, EGRN	1
2344	Container Flat-top, Mirror Foot Circle	38.1 × 71.1cm	45L	GRAY, BLA	1
2345	Container Flat-top, Titanium Foot Circle	38.1 × 71.1cm	45L	CR, EGRN	1
2354	Container Round-top, Mirror Foot Circle	38.1 × 76.0cm	45L	GRAY, BLA	1
2355	Container Round-top, Titanium Foot Circle	38.1 × 76.0cm	45L	CR, EGRN	1
2364	Container Round-top, Mirror Foot Circle	38.1 × 91.4cm	56L	GRAY, BLA	1
2365	Container Round-top, Titanium Foot Circle	38.1 × 91.4cm	56L	CR, EGRN	1
2374	Container Open-top, Mirror Foot Circle	254 × 38.1cm	18L	GRAY, BLA	1
2375	Container Open-top, Titanium Foot Circle	254 × 38.1cm	18L	CR, EGRN	1



## STEELEDGE® CONTAINERS



### PRODUCT FEATURES:

1. Made of heavy-duty fireproof material, extreme durability.
2. Powder coated surface.
3. Rubber rim effectively reduces damage to the product.
4. Unique base design protects floors from dispersing.
5. Auto closing heavy duty stainless steel door prevents odor.
6. 2353 and 2363 have recessed handles that facilitate moving and dumping.
7. Included leak-proof inner container is made of galvanized steel.



Model	Description	Dimensions	Capacity	Color	Pack
2313	Ashtray/Trash, Spray Surface	25.4 × 68.6cm	13L	BLUE, GRAY, GRN, RED	1
2323	Container Open-top, Spray Surface	38.1 × 71.1cm	56L	BLUE, GRAY, GRN, RED	1
2333	Ashtray/Trash, Spray Surface	38.1 × 72.6cm	45L	BLUE, GRAY, GRN, RED	1
2343	Container Flat-top, Spray Surface	38.1 × 71.1cm	45L	BLUE, GRAY, GRN, RED	1
2353	Container Round-top, Spray Surface	38.1 × 76.0cm	45L	BLUE, GRAY, GRN, RED	1
2363	Container Round-top, Spray Surface	38.1 × 91.4cm	56L	BLUE, GRAY, GRN, RED	1
2373	Container Open-top, Spray Surface	25.4 × 38.1cm	18L	BLUE, GRAY, GRN, RED	1

## ALUMINUM TRASH CANS



### PRODUCT FEATURES:

1. An ideal choice for airports, office buildings, and shopping centers.
2. Made of heavy-duty aluminum alloy, ensuring corrosion and rust resistance, extreme durability.
3. Special treatments deliver a scratch-proof surface.
4. The concealed trash bag design makes for a clean and tidy appearance.
5. Fire-resistant.



The design of **concealed trash bag** provides a clean and tidy appearance

Model	Description	Dimensions	Capacity	Color	Pack
2391	Aluminum Trash Can	32.0 × 70.0cm	45L	MSILV	1
2392	Aluminum Trash Can	38.0 × 77.5cm	65L	MSILV	1
2393	Aluminum Trash Can	45.7 × 81.9cm	110L	MSILV	1



# DECORATIVE WASTE CONTAINERS

## OPEN TRASH CANS

### PRODUCT FEATURES:

1. Ideal for use in restaurants, hotels, airports, and train stations.
2. Made of heavy-duty fireproof material, extreme durability.
3. Unique base design protects floors.
4. Leak-proof galvanized steel inner container included.
5. For indoor use.



1318



1319



Model	Description	Dimensions	Capacity	Color	Pack
1318	Domed Open Trash Can	39.0 × 87.5cm	50L	BLA	1
1319	Top Open Trash Can	35.5 × 57.5cm	40L	SS	1

## ROUND STAINLESS STEEL STEP-ON CONTAINERS

### PRODUCT FEATURES:

1. Made of heavy-duty fireproof material, extreme durability.
2. Unique base design protects floors.
3. Quiet, heavy-duty pedal for hands-free hygienic use.
4. Soft-close lid prevents noise effectively.
5. Variety of capacity for choosing.
6. For indoor use.



1310



1312



1313



Model	Description	Dimensions	Capacity	Color	Pack
1310	Round Stainless Steel Step-on Container	20.5 × 32.0cm	7L	SSS	1
1311	Round Stainless Steel Step-on Container	25.0 × 40.0cm	12L	SSS	1
1312	Round Stainless Steel Step-on Container	29.2 × 45.0cm	20L	SSS	1
1313	Round Stainless Steel Step-on Container	29.2 × 64.0cm	30L	SSS	1



## ROUND STAINLESS STEEL STEP-ON CONTAINERS



### PRODUCT FEATURES:

1. Made of heavy-duty fireproof material, extreme durability.
2. Hidden handle on the back, convenient for handling.
3. Unique base design protects floors.
4. Quiet, heavy-duty pedal for hands-free hygienic use.
5. Soft-close lid prevents noise effectively.
6. Wide choice of capacity.
7. For indoor use.



Model	Description	Dimensions	Capacity	Color	Pack
1322	Round Stainless Steel Step-on Container	25.0 × 41.5cm	12L	SSS	1
1323	Round Stainless Steel Step-on Container	29.2 × 47.3cm	20L	SSS	1
1324	Round Stainless Steel Step-on Container	29.2 × 66.0cm	30L	SSS	1

## ROUND STAINLESS STEEL STEP-ON CONTAINERS



### PRODUCT FEATURES:

1. Made of heavy-duty fireproof material, extreme durability.
2. Unique base design protects floors.
3. Quiet, heavy-duty pedal for hands-free hygienic use.
4. Soft-close lid prevents noise effectively.
5. Wide choice of capacity.
6. For indoor use.



Model	Description	Dimensions	Capacity	Color	Pack
1325	Round Stainless Steel Step-on Container	28.5 × 33.8cm	12L	SSS	1
1326	Round Stainless Steel Step-on Container	33.5 × 47.5cm	20L	SSS	1
1327	Round Stainless Steel Step-on Container	33.5 × 67.2cm	30L	SSS	1



## SVELTE® STAINLESS STEEL STEP-ON CONTAINERS



### PRODUCT FEATURES:

1. The slim rectangle shape is space efficient and fits tight spaces.
2. Made of heavy-duty fireproof material, extreme durability.
3. Hidden handle on the back, convenient for handling.
4. Unique base design protects floors.
5. Quiet, heavy-duty pedal for hands-free hygienic use.
6. Soft-close lid prevents noise effectively.
7. For indoor use.



Soft-close lid prevent noise effectively



1314



1315



1316



1317

Model	Description	Dimensions	Capacity	Color	Pack
1314	SVELTE® Stainless Steel Step-on Container	34.0 × 32.0 × 60.8cm	30L	SSS	1
1315	SVELTE® Stainless Steel Step-on Container	42.6 × 37.2 × 63.5cm	50L	SSS	1
1316	SVELTE® Stainless Steel Step-on Container	38.0 × 35.0 × 66.0cm	40L	SSS	1
1317	SVELTE® Stainless Steel Step-on Container	51.5 × 25.0 × 64.0cm	45L	SSS	1

## SEMICIRCULAR STAINLESS STEEL STEP-ON TRASH CANS



### PRODUCT FEATURES:

1. Semicircular design can be put close to the wall to save space.
2. Unique base design protects floors.
3. Hidden handle on the back, convenient for handling.
4. Quiet, heavy-duty pedal for hands-free hygienic use.
5. Soft-close lid prevents noise effectively.
6. For indoor use.



Hidden handle on the back for easy handling



1320



1321

Model	Description	Dimensions	Capacity	Color	Pack
1320	Semicircular Stainless Steel Step-on Trash Can	30.0 × 28.5 × 40.5cm	12L	SSS	1
1321	Semicircular Stainless Steel Step-on Trash Can	39.0 × 36.0 × 67.5cm	40L	SSS	1

## NEATACE® CLASSIC HANDS-FREE TRASH CANS

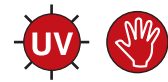

### PRODUCT FEATURES:

1. Classic and simple style, suitable for places with a variety of architectural styles.
2. Durable molded construction with smooth surfaces, easy to clean.
3. Concealed trash bag design makes for a clean and tidy appearance.



2208

2209

2213

Model	Description	Dimensions	Capacity	Color	Pack
2202	NEATACE® Trash Can, Ashtray Top Cover without Valves	Dia 38.0 × 93.0cm	56L	BEIG, BLA	1
2203	NEATACE® Trash Can, Open Top Cover	Dia 38.0 × 76.0cm	56L	BEIG, BLA	1
2205	NEATACE® Trash Can, Spherical Top Cover, Top Open	Dia 38.0 × 91.5cm	56L	BEIG, BLA	1
2208	NEATACE® Trash Can, Ashtray Top Cover without Valves	Dia 43.9 × 107.0cm	95L	BEIG, BLA	1
2209	NEATACE® Trash Can, Open Top Cover	Dia 43.9 × 85.0cm	95L	BEIG, BLA	1
2213	NEATACE® Trash Can, Spherical Top Cover, Top Open	Dia 43.9 × 104.8cm	95L	BEIG, BLA	1

## NEATACE® CLASSIC TRASH CANS



### PRODUCT FEATURES:

1. Classic and simple style, suitable for places with a variety of architectural styles.
2. Durable molded construction with smooth surfaces, easy to clean.
3. Concealed trash bag design makes for a clean and tidy appearance.
4. Hinged opening makes garbage disposal easier with the shutter automatically closing - effectively controlling odors and preventing the entry of mosquitoes and flies.



2206

2207

2210

Model	Description	Dimensions	Capacity	Color	Pack
2200	NEATACE® Trash Can, Dome Cover	Dia 38.0 × 92.7cm	56L	BEIG, BLA	1
2201	NEATACE® Trash Can, Ashtray Top Cover with Valves	Dia 38.0 × 93.0cm	56L	BEIG, BLA	1
2204	NEATACE® Trash Can, Spherical Top Cover	Dia 38.0 × 92.7cm	56L	BEIG, BLA	1
2206	NEATACE® Trash Can, Dome Cover	Dia 43.9 × 106.6cm	95L	BEIG, BLA	1
2207	NEATACE® Trash Can, Ashtray Top Cover with Valves	Dia 43.9 × 107.0cm	95L	BEIG, BLA	1
2210	NEATACE® Trash Can, Spherical Top Cover	Dia 43.9 × 106.6cm	95L	BEIG, BLA	1

## RISTON® DECORATIVE CONTAINERS



### PRODUCT FEATURES:

1. Ideal for use in building entrances, lobbies and shopping malls.
2. Attractive design with side-door for easy cleaning.
3. Durable molded construction with smooth surfaces, easy to clean.
4. Hinged opening makes garbage disposal easier with the shutter automatically closing - effectively controlling odors and preventing the entry of mosquitoes and flies.
5. Can be fixed to the ground with screws.
6. Built-in tray holder on top of 2103 for trays of 38 × 51cm.
7. Built-in garbage bag holder, convenient to fix the garbage bag.
8. Optional hard inner bins, suitable for storing sharp and heavy waste.

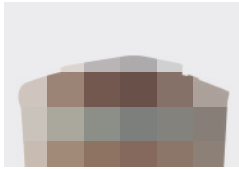

Built-in tray holder on top of model 2103 for trays of 38 × 51cm

Model	Description	Dimensions	Capacity	Color	Pack
2101	RISTON® Decorative Container	62.9 × 64.0 × 107.0cm	190L	GRN, BEIG, BLA	1
2102	RISTON® Decorative Container, Ashtray Top	62.9 × 64.0 × 107.0cm	190L	GRN, BEIG, BLA	1
2103	RISTON® Decorative Container, Tray Top	62.9 × 64.0 × 107.0cm	190L	BEIG, BLA	1
2106	RISTON® Decorative Container	54.4 × 51.6 × 104.0cm	132L	GRN, BEIG, BLA	1
2107	RISTON® Decorative Container, Ashtray Top	54.4 × 51.6 × 104.0cm	132L	GRN, BEIG, BLA	1
1281	Rigid Liner, for 2106/2107	36.6 × 36.6 × 71.0cm	75L	GRAY	4
1282	Rigid Liner, for 2101/2102/2103	49.5 × 49.5 × 70.2cm	132L	GRAY	4

## BEAUCAN® OUTDOOR DECORATIVE TRASH CANS

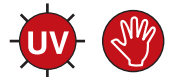

### PRODUCT FEATURES:

1. Designed for stadiums, parks, shopping malls, and other high-traffic areas.
2. Durable molded construction with smooth surfaces, easy to clean.
3. Permanently attached hinged lid for easy emptying.
4. Metal retainers keep can liners securely in place and eliminate knot tying.
5. Stable base to increase stability.
6. 2111 with double sided movable flaps, effectively controlling odor overflow and preventing the entry of mosquitoes and flies.
7. 2112 four-sided opening, suitable for places with high traffic.
8. Optional hard inner bins, suitable for storing sharp and heavy waste.



Permanently attached hinged lid for easy emptying

Model	Description	Dimensions	Capacity	Color	Pack
2111	BEAUCAN® Decorative Trash Can, Two Sides of Movable Doors	63.2 × 63.2 × 105.4cm	170L	BEIG, BLA	1
2112	BEAUCAN® Decorative Trash Can, Four-sided Openings	63.2 × 63.2 × 105.4cm	170L	BEIG, BLA	1
2113	BEAUCAN® Decorative Trash Can, Double Sided Movable Flaps	54.6 × 54.6 × 104.0cm	132L	BEIG, BLA, BRN	1
1282	Rigid Liner, for 2111/2112	49.5 × 49.5 × 70.2cm	132L	GRAY	4
1284	Rigid Liner, for 2113	41.2 × 41.2 × 72.4cm	90L	GRAY	4



# DECORATIVE WASTE CONTAINERS



## Terminator® Cigarette Butt Buckets

Exquisite design, metal construction, beautiful and efficient cigarette butt management solution.

- Innovative patented structure allows for easy emptying without additional tools.
- Elegant and durable, made from aviation aluminum alloy to ensure corrosion and rust resistance.
- Heavy base and fixtures provide high stability and security for outdoor use.
- Locking device effectively prevents vandalism and theft.
- Excellent sealing helps extinguish cigarette butts.

## Complete Solutions for a Variety of Locations

- Restaurants and Bars
- Shopping Centers
- Office Buildings
- Playgrounds and Parks
- Airports, Bus and Railway Stations
- Health Facilities
- Hotels and Resorts
- Clubs
- Manufacturing Plants
- Convention and Exhibition Centers



## TERMINATOR® FLOOR-STANDING CIGARETTE BUTT BUCKETS

### PRODUCT FEATURES:

1. Designed with large capacity, an ideal cigarette butt collector in stadiums, gymnasiums, parks, hotels, office buildings and public places.
2. Elegant and durable, made from aviation aluminum alloy to ensure corrosion and rust resistance.
3. Stylish modern design is suitable for a variety of architectural styles.
4. Heavy base and fixtures provide high stability and security for outdoor use.
5. Liner with excellent sealing immediately extinguishes cigarette butts.
6. Allows for simple and fast emptying.



Open the cigarette butts bucket with a key to remove the liner



Open the bottom of the liner to empty the cigarette butts



2261

2271

2281

2291

Model	Description	Dimensions	Capacity	Cigarette Butts Number	Color	Pack
2261	TERMINATOR® Floor-standing Cigarette Butts Bucket	30.0 × 90.0cm	6.7L	1900	MSILV	1
2271	TERMINATOR® Floor-standing Cigarette Butts Bucket	30.0 × 104.0cm	9.8L	2800	MSILV	1
2281	TERMINATOR® Floor-standing Cigarette Butts Bucket	30.0 × 30.0 × 125.0cm	6.9L	2000	MSILV	1
2291	TERMINATOR® Floor-standing Cigarette Butts Bucket	37.0 × 30.0 × 138.0cm	6.9L	2000	MSILV	1

## TERMINATOR® WALL-MOUNTED CIGARETTE BUTTS BUCKETS

### PRODUCT FEATURES:

1. Suitable for smoking areas either outdoor or indoor.
2. Elegant and durable, made from aviation aluminum alloy to ensure corrosion and rust resistance.
3. Stylish modern design is suitable for a variety of architectural styles.
4. Excellent sealing assists immediately extinguishing cigarette butts.
5. Allows for simple and fast emptying.



2211



2221

Model	Description	Dimensions	Capacity	Cigarette Butts Number	Color	Pack
2211	TERMINATOR® Wall-mounted Cigarette Butts Bucket	8.0 × 8.0 × 48.0cm	2.5L	700	MSILV	1
2221	TERMINATOR® Wall-mounted Cigarette Butts Bucket	8.0 × 8.0 × 48.0cm	2.5L	700	MSILV	1

## TERMINATOR® WALL-MOUNTED CIGARETTE BUTTS BUCKETS

### PRODUCT FEATURES:

1. Suitable for smoking areas either outdoor or indoor.
2. Elegant and durable, made from aviation aluminum alloy to ensure corrosion and rust resistance.
3. Stylish modern design is suitable for a variety of architectural styles.
4. Excellent sealing assists immediately extinguishing cigarette butts.
5. Allows for simple and fast emptying.



2231



2241



Model	Description	Dimensions	Capacity	Cigarette Butts Number	Color	Pack
2231	TERMINATOR® Wall-mounted Cigarette Butts Bucket	8.0 × 48.0cm	1.8L	550	MSILV	1
2241	TERMINATOR® Wall-mounted Cigarette Butts Bucket	8.0 × 48.0cm	1.8L	550	MSILV	1

## TERMINATOR® WALL-MOUNTED CIGARETTE BUTTS BUCKETS

### PRODUCT FEATURES:

1. Suitable for smoking areas either outdoor or indoor.
2. Titanium alloy cover, fine and stylish, for use in the high-end facilities.
3. Stylish modern design is suitable for a variety of architectural styles.
4. Excellent seal assists immediate extinguishing of cigarette butts.
5. Allows for simple and fast emptying.



2212



2242

Model	Description	Dimensions	Capacity	Cigarette Butts Number	Color	Pack
2212	TERMINATOR® Wall-mounted Cigarette Butts Bucket	8.0 × 8.0 × 48.0cm	1.8L	550	TITA	1
2242	TERMINATOR® Wall-mounted Cigarette Butts Bucket	8.0 × 48.0cm	1.3L	400	TITA	1



Smoking Area



## TERMINATOR® FLOOR-STANDING CIGARETTE BUTT BUCKETS

### PRODUCT FEATURES:

1. Designed with large capacity, an ideal cigarette butt collector in stadiums, gymnasiums, parks, hotels, office buildings and public places.
2. Innovative unibody design; collects small sized litter conveniently.
3. Elegant and durable, made from aviation aluminum alloy to ensure corrosion and rust resistance.
4. Stylish modern design is suitable for a variety of architectural styles.
5. Heavy base and fixtures provide high stability and security for outdoor use.
6. Liner with excellent sealing immediately extinguishes cigarette butts.
7. Allows for simple and fast emptying.



2262

Model	Description	Dimensions	Capacity	Cigarette Butts Number	Color	Pack
2262	TERMINATOR® Floor-standing Cigarette Butts Bucket	45.0 × 30.0 × 90.0cm	6.7L	1900	MSILV	1

## TERMINATOR® LARGE-CAPACITY CIGARETTE BUTT BUCKETS

### PRODUCT FEATURES:

1. Ideal cigarette butt collection for smoking areas.
2. Elegant and durable, made from aviation aluminum alloy to ensure corrosion and rust resistance.
3. Stylish modern design is suitable for a variety of architectural styles.
4. Side opening available for collection of cigarette packs and other small garbage.



Removable large capacity

Cigarette butt liner has a cigarette pack entrance for added versatility



2251

Model	Description	Dimensions	Capacity	Cigarette Butts Number	Color	Pack
2251	TERMINATOR® Large-capacity Cigarette Butts Bucket	21.0 × 80.0cm	1L	280	MSILV	1

## STEELEDGE® CIGARETTE BARRELS

### PRODUCT FEATURES:

1. Ideal for use in hotels, clubs and office buildings.
2. Made of heavy-duty fireproof material, extremely durable.
3. Unique base design protects floors.
4. Fine, high-end surface treatment.



2305

2300

2302

Model	Description	Dimensions	Capacity	Color	Pack
2300	Cigarette Barrel, Mirror Chrome	25.4 × 51.0cm	N/A	SS	1
2301	Cigarette Barrel, Satin Stainless Steel	25.4 × 51.0cm	N/A	SSS	1
2302	Cigarette Barrel, Titanium Surface	25.4 × 51.0cm	N/A	TITA	1
2303	Cigarette Barrel, Spray Surface	25.4 × 51.0cm	N/A	BLUE, GRAY, GRN, RED	1
2304	Cigarette Barrel, Mirror Foot Circle	25.4 × 51.0cm	N/A	GRAY, BLA	1
2305	Cigarette Barrel, Titanium Foot Circle	25.4 × 51.0cm	N/A	CR, EGRN	1

## STEELEDGE® ASHTRAY/TRASHES

### PRODUCT FEATURES:

1. Ideal for the use in hotels, clubs and office buildings.
2. Made of heavy-duty fireproof material, extreme durable.
3. Rubber rim effectively reduces damage to the product.
4. Unique base design protects floors.
5. Included leak-proof inner container is made from galvanized steel.



2331

2312

2335

2310

Model	Description	Dimensions	Capacity	Color	Pack
2310	Ashtray/Trash, Mirror Chrome	25.4 × 68.6cm	13L	SS	1
2311	Ashtray/Trash, Satin Stainless Steel	25.4 × 68.6cm	13L	SSS	1
2312	Ashtray/Trash, Titanium Surface	25.4 × 68.6cm	13L	TITA	1
2313	Ashtray/Trash, Spray Surface	25.4 × 68.6cm	13L	BLUE, GRAY, GRN, RED	1
2314	Ashtray/Trash, Mirror Foot Circle	25.4 × 68.6cm	13L	GRAY, BLA	1
2315	Ashtray/Trash, Titanium Foot Circle	25.4 × 68.6cm	13L	CR, EGRN	1
2330	Ashtray/Trash, Mirror Chrome	38.1 × 72.6cm	45L	SS	1
2331	Ashtray/Trash, Satin Stainless Steel	38.1 × 72.6cm	45L	SSS	1
2332	Ashtray/Trash, Titanium Surface	38.1 × 72.6cm	45L	TITA	1
2333	Ashtray/Trash, Spray Surface	38.1 × 72.6cm	45L	BLUE, GRAY, GRN, RED	1
2334	Ashtray/Trash, Mirror Foot Circle	38.1 × 72.6cm	45L	GRAY, BLA	1
2335	Ashtray/Trash, Titanium Foot Circle	38.1 × 72.6cm	45L	CR, EGRN	1





## THOR® RIM CADDIES

### PRODUCT FEATURES:

1. Snaps securely onto rim of 166L round container (1014).
2. Built-in bag straps allow for easy poly liner attachment.
3. User-friendly handle improves maneuverability and minimizes contact with refuse.
4. Provides storage for spray bottles, safety signs, cleaning sponges, lobby dust pan, brushes, liners, gloves etc.
5. Made of tough and durable plastic.
6. Smooth surfaces allow for easy cleaning.



1821



1014/1821/1811

Model	Description	Dimensions	Capacity	Color	Pack
1014	THOR® Round Container	61.0 × 80.0cm	166L	GRAY	4
1811	THOR® Dolly for 1010/1012/1013/1014/1015	46.4 × 16.8cm	N/A	BLA	2
1821	THOR® Rim Caddy for 1014	88.2 × 70.3 × 17.0cm	N/A	YEL	1

## THOR® CADDY BAGS

### PRODUCT FEATURES:

1. Nylon reinforced vinyl bags are durable and easy to maintain cleanliness.
2. Pockets of various sizes are available for placing various cleaning supplies.



1014/1831/1811

Model	Description	Dimensions	Capacity	Color	Pack
1831	THOR® Caddy Bag for 1013/1014	Dia 50.8 × 52.1cm	N/A	YEL	6

## CARRY CADDIES

### PRODUCT FEATURES:

1. Perfect for carrying tools or cleaning supplies.
2. Securely fits on to the brim of 121L (1013) Round Container.
3. User friendly handles fit your hand and allow for a comfortable grip.
4. Securely holds Spray Bottles (6947) and other common cleaning tools.
5. Allows for stable stacking to save space.
6. Rounded corners ensure safety and prevent against injury.

## SIGNBOARD HOOKS

### PRODUCT FEATURES:

1. An ideal solution for hanging Floor Safety Signs (7114, 7161, 7162, 7163).
2. Tightening lock positioned on the brim of 121L Round Container (1013).
3. Made of sturdy, durable plastics.



1823



1822



Model	Description	Dimensions	Capacity	Color	Pack
1822	Signboard Hook	15.3 × 10.0 × 6.0cm	N/A	BLA	6
1823	Carry Caddy	37.5 × 32.0 × 18.0cm	N/A	BLA	4

## THOR® DOLLIES

### PRODUCT FEATURES:

1. Easy mobility and maneuverability of heavy loads.
2. Swivel castors offer easy mobility.
3. Attach trash containers with ease.



1811



1812



1813



1818



Foot fixing position, easy loading and unloading

Model	Description	Dimensions	Capacity	Color	Pack
1811	THOR® Dolly for 1010/1012/1013/1014/1015	46.4 × 16.8cm	N/A	BLA	2
1812	THOR® Square Dolly for 1231/1233	43.8 × 15.9cm	N/A	BLA	2
1813	THOR® Quiet Dolly for 1010/1012/1013/1014/1015	46.4 × 16.8cm	N/A	BLA	2
1818	THOR® Drum Dolly for 1010/1012/1013/1014/1015/1231/1233	114.3 × 51.4 × 20.3cm	N/A	BLA	1



## SVELTE® RIM CADDIES AND DOLLIES



### PRODUCT FEATURES:

1. The combined cleaning system is composed of Svelte® trolley, Svelte® trash can and Svelte® tool assembly rack, which is convenient and efficient to collect garbage and carry cleaning tools.
2. The slim rectangle shape is space efficient and fits tight spaces.
3. Convenient for sorting collection.
4. Svelte® Dollies (1825), sturdy structural foam construction won't rust, dent, chip, or peel; 7.5cm non-marking castors - prevent floor marking and reduce post-job clean up.
5. When used with the connection device (1826), the two trolleys can be firmly connected together to improve work efficiency.

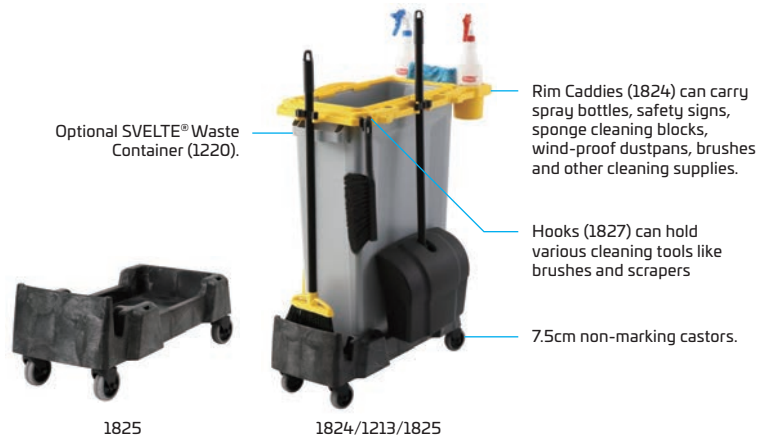

**Rim Caddies (1824)** hold a safety sign



**Rim Caddies (1824)** can secure two garbage bags on the rim for efficient classification collection



**Rim Caddies (1824)** elastic clamp can hold broom and mop handles with diameter 2.2 to 2.9cm



**Dolly Connectors (1826)** connects several dollies for collection and transportation purposes

Model	Description	Dimensions	Capacity	Color	Pack
1213	SVELTE® Container	57.0 × 27.2 × 75.6cm	87L	BLA, LGRAY	4
1220	SVELTE® Container	51.3 × 27.2 × 75.6cm	87L	BLA, LGRAY	4
1814	SVELTE® Dolly for 1211/1213/1220	51.6 × 29.0 × 26.0cm	N/A	BLA	2
1824	SVELTE® Rim Caddy for 1211/1213/1220	74.6 × 37.6 × 11.9cm	N/A	YEL, BLA	1
1825	SVELTE® Dolly for 1211/1213/1220	63.5 × 30.0 × 24.6cm	N/A	BLA	2
1826	SVELTE® Connector for 1825	15.9 × 10.9 × 11.4cm	N/A	BLA	1

## SVELTE® CADDY BAGS

### PRODUCT FEATURES:

1. Nylon reinforced vinyl bags are durable and easy to maintain cleanliness.
2. Pockets of various sizes are available for placing various cleaning supplies.
3. Used with Svelte® trash can and Svelte® trolley (1814, 1825) provides a convenient and efficient method to collect garbage and carry cleaning tools.

## SVELTE® HOOKS

### PRODUCT FEATURES:

1. Tightening lock on the brim of Rim Caddies (1824).
2. Suitable for hanging all kinds of cleaning tools.
3. Made of sturdy, durable plastics.



1827



1828/1213/1825

Model	Description	Dimensions	Capacity	Color	Pack
1827	SVELTE® Hook for 1824	4.3 × 3.6 × 4.2cm	N/A	YEL, BLA	4
1828	SVELTE® Caddy Bag for 1213	50.0 × 48.0cm	N/A	YEL, BLA	2

## WASTE CLASSIFICATION SYMBOLS



### PRODUCT FEATURES:

1. Helpful for waste classification.
2. Self-adhesive PVC sticker, easy to attach and scrub-resistant.

Model	Description	Dimensions	Pack
1940	"Recyclable Waste" Label	13.0 × 23.0cm	10
1941	"Soil" Label	13.0 × 23.0cm	10
1942	"Building Materials" Label	13.0 × 23.0cm	10
1943	"Garden Waste" Label	13.0 × 23.0cm	10
1944	"Food Waste" Label	13.0 × 23.0cm	10
1945	"Paint" Label	13.0 × 23.0cm	10
1946	"Household and Garden Chemicals" Label	13.0 × 23.0cm	10
1947	"Mixed Paper and Card" Label	13.0 × 23.0cm	10
1948	"Plastics" Label	13.0 × 23.0cm	10
1949	"Mixed Textiles and Clothes" Label	13.0 × 23.0cm	10
1950	"Mixed Glass" Label	13.0 × 23.0cm	10
1951	"Metal" Label	13.0 × 23.0cm	10
1952	"Batteries" Label	13.0 × 23.0cm	10



Helpful for waste classification and management.

## SVELTE® DOLLIES

### PRODUCT FEATURES:

1. Sturdy structural foam construction will not rust, dent or chip.
2. 7.5cm non-marking castors.
3. Easy mobility and maneuverability of heavy loads.
4. Multi-compartment dollies can easily move multiple containers and facilitate waste classification.



Model	Description	Dimensions	Capacity	Color	Pack
1814	SVELTE® Dolly, for 1211/1212/1213/1214/1220/1221	51.6 × 29.0 × 26.0cm	N/A	BLA	2
1815	SVELTE® Double-compartment Dolly, for 1211/1212/1213/1214/1220/1221	58.2 × 51.7 × 24.0cm	N/A	BLA	1
1816	SVELTE® Tri-compartment Dolly, for 1211/1212/1213/1214/1220/1221	87.3 × 51.7 × 24.0cm	N/A	BLA	1
1817	SVELTE® Four-compartment Dolly, for 1211/1212/1213/1214/1220/1221	116.4 × 51.7 × 24.0cm	N/A	BLA	1



**CLEANING CARTS**

Grandmaid® Housekeeping Carts	68
Pinnacle® Intelligent Housekeeping Cart	72
Cleabox® Room Service Carts	74
Grandmaid® Cleaning Carts	76

**CLEANING CART COMBINATION**

Svelte® Rim Caddies, Dollies & Caddy Bags	78
Thor® Rim Caddies & Caddy Bags	79
Svelte® Hooks	79
Carry Caddies	80
Signboard Hooks	80
Collapsible Linen Carts	81
Cover	81
X Type Linen Carts	82

**MOPPING SYSTEMS**

All-in-one Buckets	84
Grandmaid® Press Combos and Accessories	85
Pedal Mop Wringers	88

Pail and Mop Strainer Combinations

Double Pails	89
Steel Sponge Mops	89
Buckets	90

**WET MOPS**

Wet Mop Selection Guide	92
Blend Mops	94
Cotton Mops	94
Superfine Fiber Mops	94
Economy Cotton Mops	95
Finish Mops	95
Clean Room Mops	95
Superfine Fiber Mops	96
Microfiber Mops	96
Quick Connect Mops	97
Synthetic Fiber Mops	98
Antibiotic Blended Mops	98
Antibiotic Microfiber Mops	98

**WET MOP HANDLES**

Wet Mop Handles	100
Naelc® Aluminum Quick Connect Handles	101

**DUST MOPS**

Dust Mop Selection Guide	102
Naelc® Quick Connect Handles and Frames	103
Naelc® Dust Mops	104
Naelc® Dry Mops	104
Naelc® Wet Mops	104
Naelc® Dust Mop Handles and Frames	105
Naelc® Dust Mops	105
Wedge Dust Mops	105

**MICROFIBER CLEANING SYSTEM**

Microfiber Technology	106
U-Rag® Microfiber Cloths	108
U-Rag® Superfine Fiber Cloths	109
U-Rag® Microfiber Mitts and Dusters	109
Laundry Nets	110



## BROOMS AND BRUSHES

Brooms and Brushes Components	112
Angle Brooms	114
Floor Sweeps	114
Toilet Brushes	118
Wire Brushes	118
Counter Brushes	119
Plastic Handle Utility Brushes	119
Scrub Brushes	120
Wash Brushes	120
Broom Handles	121
Toilet Brushes	122
Scouring Pad Cleaning Systems	123
Corn Brooms	124
Condenser Cleaning Brushes	124
Dusting Brushes	124
Shoe Brushes	125
Pipe Brushes	125

## DUST PANS

Predator® Upright Dust Pans	126
Dust Pans	127
Step&Sweep Dust Pans	127

## FLOOR SQUEEGEES

Traditional Floor Squeegees	128
Dual Moss Squeegees	128
Professional Plastic Squeegees	129

## DUSTING TOOLS

Dusters	130
Overhead Dusting Tool with Flexible Head	130
Wall Washer Kits	131

## AUXILIARY CLEANING TOOLS

Cleaning Tool Holders	132
Ironing Organizers	133
Cleaning and Maintenance Gloves	133
Professional Kneepads	133

Stepstools	134
Rotomolded Plastic Pedals	134
Ladders	135
Deluxe Carry Caddies	136
Nozzle and Spray Bottles	137
Pneumatic Sprayers	137
Nippers	138
Toilet Pumps	138
Scrapers	138

## WASHROOM

Heimdall® Baby Changing Stations	140
Kid&Cool® Infant Safety Seats	141
Wall-mounted Sanitary Napkin Receptacles	142
Feminine Sanitary Bins	142
Bath Mats	142



## Professional Cleaning

At TRUST we are committed to improving cleaning efficiency and to developing high quality products for professional cleaning. Our products have been rigorously tested to be durable, saving your time and money.

## Efficient Microfiber Cleaning

High quality microfiber material improves sterilization efficacy and reduces costs.

## Innovative Solutions

Our professional cleaning solutions provide you with superior performance.



## Introducing the **PINNACLE® SMART ELECTRIC ROOM SERVICE CART**

Innovative product design which provides you with a complete solution to meet all your room service needs. The Pinnacle® Electric Room Service Cart is equipped with intelligent and easy to operate functions. There are various accessories available, which help to improve the work flow and efficiency.

TRUST provides you with a variety of room service carts to meet your needs in different places. Please contact your local dealer for more details.



## Various Accessories

A variety of accessories are available to improve the work flow and work efficiency.

# CLEANING CARTS



## GRANDMAID® HOUSEKEEPING CARTS



### PRODUCT FEATURES:

1. A complete system solution for housekeeping in hotels.
2. Durable molded construction with smooth surfaces, easy to clean.
3. 20cm wheels make moving easier.
4. Friendly handles are easy to grip and help to maneuver the cart for user.
5. Bumpers available at four corners to protect walls and equipment.
6. Full size cabinet offers exceptional storage space and adjustable middle shelf.

User friendly handles are easy and comfortable to grip and help maneuver the cart



Built-in hook for hanging various tools and bags



Innovative hook makes hanging tissue paper and cleaning cloths easier

### CHOOSE SUITABLE ACCESSORIES

Various accessories to choose from to efficiently and easily cope with different work needs. Enhance your image and satisfy high-end service needs.



Model	Description	Dimensions	Capacity	Color	Pack
5021	GRANDMAID® Housekeeping Cart	152.4 × 55.9 × 127.0cm	N/A	BLA, PLAT	1
5022	GRANDMAID® Housekeeping Cart with Doors	152.4 × 55.9 × 127.0cm	N/A	BLA	1
5023	GRANDMAID® Housekeeping Cart with Doors, Protective Security Hood	152.4 × 55.9 × 157.0cm	N/A	BLA	1

# ACCESSORIES

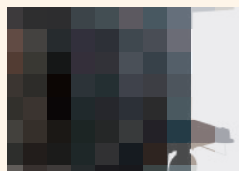

**Lockable door assembly (5026)** for safe and concealed storage of supplies



**Nine-compartment bag (6975)** can carry spray bottles, cleaning cloths, brushes and other cleaning supplies

Model	Description	Dimensions	Capacity	Color	Pack
5027	Protective Security Hood for 5021/5022/5023/5031	80.6 × 51.5 × 44.5cm	N/A	BLA, PLAT	1
5028	Cover, Compatible with 6968/6974/6977	47.1 × 29.1 × 2.1cm	N/A	BLA, PLAT	2
5029	Amenity Organizer	49.5 × 30.8 × 6.0cm	N/A	BLA	6
5030	Amenity Organizer	49.5 × 30.8 × 6.0cm	N/A	BLA	6
5039	Protective Security Hood for 5021/5022/5023/5031	80.6 × 51.5 × 37.0cm	N/A	BLA	1
5056	Garbage Classification Fixed Frame (½ Separated) for 5021/5022/5023/5031	45.7 × 28.0 × 3.3cm	N/A	BLA	1
5057	Garbage Classification Fixed Frame (⅓ and ⅔ Separated) for 5021/5022/5023/5031	45.7 × 28.0 × 3.3cm	N/A	BLA	1
5067	Safety Shield	80.3 × 52.8 × 36.6cm	N/A	BLA, PLAT	1
5077	Safety Shield, No Fipped Door	80.3 × 52.8 × 36.6cm	N/A	BLA, PLAT	1
4851	Utility Sliding Drawer	65.7 × 43.0 × 8.2cm	N/A	BLA, BRN	1
5024	Adjustable Shelf Kit for 5021/5022/5023/5031	76.5 × 47.0 × 5.7cm	N/A	BLA, PLAT	1
5026	Locking Door Kit for 5021/5022/5023	86.4 × 44.8 × 4.5cm	N/A	BLA, BRN	1
6953	Three-sided Multi-layer Storage Bag for 5021/5022/5023	44.0 × 26.5 × 82.0cm	N/A	BRN	2
6954	Large Capacity of Side Hanging Bag for 5021/5022/5023/5031	88.0 × 31.5cm	N/A	BRN	6
6972	Vinyl Bag for 5021/5022/5023	83.8 × 26.7 × 42.7cm	N/A	BRN	6
6973	Canvas Linen Accessory Bag for 5021/5022/5023	83.8 × 26.7 × 42.7cm	N/A	BRN	6
6974	Fabric Mesh Linen Bag for 5021/5022/5023	83.8 × 26.7 × 42.9cm	N/A	BRN	6
6975	Fabric 9-pocket Organizer for 5021/5022/5023/5031	71.1 × 50.2 × 3.8cm	N/A	BRN	6
6976	Short Polyliner, for 5021/5022/5023/5031	53.0 × 26.7 × 42.0cm	N/A	BRN	6
6977	Cloth/Straw Bag, for 5021/5022/5023	83.8 × 26.7 × 42.9cm	N/A	BRN	6
6979	Large-capacity Eight-compartment Bag, for 5021/5022/5023	98.5 × 78.0cm	N/A	BRN	6
4831	Pneumatic Castor Kit	Dia: 20cm	N/A	N/A	1

## GRANDMAID® COMPACT HOUSEKEEPING CARTS



### PRODUCT FEATURES:

1. A complete system solution for housekeeping in hotels.
2. Durable molded construction with smooth surfaces, easy to clean.
3. 20cm (5051 castors 18cm) non-marking castors allow for easy maneuverability.
4. Friendly handles are easy to grip and help to maneuver the cart for user.
5. Bumpers available at four corners to protect walls and equipment.
6. 5051 double shelf linen cabinet increases linen storage volume.
7. Compatible with narrow passages.



5031



5051



Innovative interface fastens buckets Svelte® Container Buckets increasing space

Model	Description	Dimensions	Capacity	Color	Pack
5031	GRANDMAID® Compact Housekeeping Cart	124.0 × 55.9 × 123.0cm	N/A	BLA, PLAT	1
5051	GRANDMAID® Cruise Housekeeping Cart	102.4 × 51.0 × 109.0cm	N/A	BLA, PLAT	1



## ACCESSORIES



5037



5052



5033



5038



5054



6968



6969



6970



5025



5036

Model	Description	Dimensions	Capacity	Color	Pack
1213	SVELTE® Container for 5031	57.0 × 27.2 × 75.6cm	87L	BRN	4
1215	SVELTE® Container for 5051	49.9 × 24.9 × 63.0cm	46L	BRN	4
1645	SVELTE® Connect Valve Style Lid for 5031	54.8 × 32.5 × 4.0cm	N/A	BLA	4
5025	Under Deck Shelf Kit for 5021/5022/5023/5031	60.0 × 53.3 × 17.7cm	N/A	BLA, PLAT	1
5033	Storage Accessory (Set of 3) for 5031	48.3 × 21.2 × 12.4cm	N/A	BLA, PLAT	1
5035	Locking Door Kit for 5031	82.4 × 44.8 × 4.5cm	N/A	BLA, BRN	1
5036	Cleaning Tool Stack for 5031	30.6 × 10.9 × 9.0cm	N/A	BLA	2
5037	Hook Kit (Set of 4 - RED, YEL, BLUE, GRN) for 5031/5051	6.9 × 4.7 × 5.0cm	N/A	N/A	1
5038	Tops Work with 1213	53.3 × 32.6 × 2.8cm	N/A	BLA, PLAT	2
5052	Locking Door Kit for 5051	68.0 × 35.8 × 1.6cm	N/A	BLA, BRN	1
5053	Under Deck Shelf Kit for 5051	58.0 × 51.0 × 17.2cm	N/A	BLA, PLAT	1
5054	Vinyl Bag for 5051	43.0 × 26.5 × 74.0cm	N/A	BRN	2
5055	Tops Work with 1215	45.0 × 25.5 × 1.2cm	N/A	BLA	2
6968	Canvas Linen Accessory Bag for 5031	79.0 × 26.7 × 42.7cm	N/A	BRN	6
6969	Fabric Mesh Linen Bag for 5031	79.0 × 26.7 × 42.7cm	N/A	BRN	6
6970	Vinyl Bag for 5031	79.0 × 26.7 × 42.7cm	N/A	BRN	6

\* Accessories 5027/5028/5029/5030/5039/5056/5057/5067/5077/4851/5024/6954/6975/6976/4831 on page 69 are also suitable for use with Compact Housekeeping Carts (5031).

## PINNACLE® INTELLIGENT HOUSEKEEPING CART



### PRODUCT FEATURES:

1. Powered housekeeping cart improves overall efficiency.
2. Intelligent control system, easy-to-operate.
3. High performance battery can power a loaded cart for up to 1 to 2 weeks.
4. Durable molded construction with smooth surfaces, easy to clean.
5. Ergonomic handles are easy to grip and help to maneuver the cart.
6. Bumpers available at four corners to protect walls and equipment.
7. Two types of top shelf are available. The top shelf fitted with dividers is a great place for organizing tools.



5061



Innovative interface fastens buckets Svelte® Container Buckets increasing space



Top shelf fitted with dividers is a great place for organizing tools



5062



5063



5064

### INTELLIGENT CONTROL SYSTEM

The system can automatically identify forward or backward; when the cart is pushed, it will move forward automatically, and when the cart is pulled, it will move backward automatically.

After the cart starts to walk, you only need to hold the handle with both hands to control the direction without any external force to pull or push; it will stop when you leave the handle.

When encountering obstacles (including human body), the system can recognize the resistance, and the cart will automatically stop moving; ensure personal and property safety.

Model	Description	Dimensions	Capacity	Color	Pack
5061	PINNACLE® Intelligent Housekeeping Cart	152.4 × 57.7 × 117.8cm	N/A	BLA	1
5062	PINNACLE® Intelligent Housekeeping Cart	152.4 × 57.7 × 122.8cm	N/A	BLA	1
5063	PINNACLE® Intelligent Housekeeping Cart	126.2 × 57.7 × 117.8cm	N/A	BLA	1
5064	PINNACLE® Intelligent Housekeeping Cart	126.2 × 57.7 × 122.8cm	N/A	BLA	1
5071	PINNACLE® Intelligent Housekeeping Cart with Built-In Divider	152.4 × 57.7 × 117.8cm	N/A	BLA	1
5072	PINNACLE® Intelligent Housekeeping Cart with Built-In Divider	152.4 × 57.7 × 122.8cm	N/A	BLA	1
5073	PINNACLE® Intelligent Housekeeping Cart with Built-In Divider	126.2 × 57.7 × 117.8cm	N/A	BLA	1
5074	PINNACLE® Intelligent Housekeeping Cart with Built-In Divider	126.2 × 57.7 × 122.8cm	N/A	BLA	1

## ACCESSORIES



5067



5037



4851

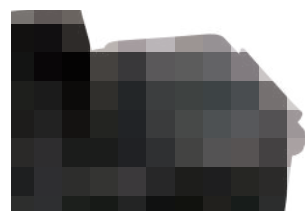

1645



6968



6969



6976



6975



1211



1213



5036



5065

Model	Description	Dimensions	Capacity	Color	Pack
<b>ACCESSORIES TO SUIT ALL PINNACLE® INTELLIGENT HOUSEKEEPING CARTS</b>					
5065	Adjustable Shelf Kit	76.1 × 47.2 × 5.5cm	N/A	BLA	1
5067	Safety Shield	80.3 × 52.8 × 36.6cm	N/A	BLA, PLAT	1
5036	Cleaning Tool Stack	30.6 × 10.9 × 9.0cm	N/A	BLA	2
5037	Hook Kit (Set of 4 - RED, YEL, BLUE, GRN)	6.9 × 4.7 × 5.0cm	N/A	N/A	1
4851	Utility Sliding Drawer	65.7 × 43.0 × 8.2cm	N/A	BLA, BRN	1
6975	Fabric 9-pocket Organizer	71.1 × 50.2 × 3.8cm	N/A	BRN	6
6976	Short Polyliner	53.0 × 26.7 × 4.2.0cm	N/A	BRN	6
5075	Battery Charger	14.0 × 6.0 × 3.5cm	N/A	BLA	1
5076	Battery Pack	23.0 × 5.5 × 15.7cm	N/A	BLA	1
<b>ACCESSORIES TO SUIT CARTS 5061/5063/5071/5073</b>					
5066	Locking Door Kit for 5061/5063/5071/5073	87.0 × 74.9 × 2.3cm	N/A	BLA	1
5068	Vinyl Bag for 5061/5063/5071/5073	79.0 × 26.7 × 4.2.7cm	N/A	BLA	6
6968	Canvas Linen Accessory Bag for 5061/5063/5071/5073	79.0 × 26.7 × 4.2.7cm	N/A	BRN	6
6969	Fabric Mesh Linen Bag for 5061/5063/5071/5073	79.0 × 26.7 × 4.2.7cm	N/A	BRN	6
<b>ACCESSORIES TO SUIT CARTS 5062/5064/5072/5074</b>					
5069	Vinyl Bag for 5062/5064/5072/5074	83.8 × 26.7 × 4.2.7cm	N/A	BLA	6
5070	Locking Door Kit for 5062/5064/5072/5074	87.0 × 79.9 × 2.3cm	N/A	BLA	1
6973	Canvas Linen Accessory Bag for 5062/5064/5072/5074	83.8 × 26.7 × 4.2.7cm	N/A	BRN	6
6974	Fabric Mesh Linen Bag for 5062/5064/5072/5074	83.8 × 26.7 × 4.2.9cm	N/A	BRN	6
6977	Cloth/Straw Bag, for 5062/5064/5072/5074	83.8 × 26.7 × 4.2.9cm	N/A	BRN	6
6979	Large-capacity Eight-compartment Bag, for 5062/5064/5072/5074	98.5 × 78.0cm	N/A	BRN	6
<b>ACCESSORIES TO SUIT CARTS 5063/5064/5073/5074</b>					
1211	SVELTE® Container	57.0 × 27.2 × 63.2cm	60L	BRN	4
1213	SVELTE® Container	57.0 × 27.2 × 75.6cm	87L	BRN	4
1645	SVELTE® Connect Valve Style Lid for 5063/5064/5073/5074	54.8 × 32.5 × 4.0cm	N/A	BLA	4

## CLEABOX® ROOM SERVICE CARTS

### PRODUCT FEATURES:

1. A fast-moving room service cart for room cleaning and environmental maintenance.
2. The surface coating is waterproof and oil proof to ensuring a professional appearance.
3. High-performance materials and high-strength structure ensure daily normal use.
4. Support plate with heavy-duty structure can prolong service life.
5. Adjustable partition plates allow you to orderly and neatly place daily necessities.
6. The side tool bag can offers a secure position for the telescopic rod (6411).
7. Waterproof side bag for the toilet brush to keep the floor clean and tidy.



5082



5081



Repels water, oil, and stains, **Teflon®** fabric protector helps maintain and protect from rigorous daily use



**Reinforced rubberized kick plate** for increased durability and reduced wear and tear



**Water proof side bag** for the toilet brush to keep the floor clean and tidy



5084

**Tool basket** is ideal for storing cleaning tools and cleaning materials. **Lined Bags** help to extend product life.

Model	Description	Dimensions	Capacity	Color	Pack
5081	CLEABOX® Room Service Cart	41.9 × 36.5 × 63.5cm	N/A	BRN	1
5082	CLEABOX® Room Service Cart	41.9 × 36.5 × 53.5cm	N/A	BRN	1
5083	CLEABOX® Room Service Cart	41.9 × 36.5 × 43.5cm	N/A	BRN	1
<b>ACCESSORIES</b>					
5084	Tool Basket	35.5 × 28.0 × 14.0cm	N/A	BRN	1
5085	Lined Bag for 5081	38.0 × 32.5 × 55.0cm	N/A	BLA	1
5086	Lined Bag for 5082	38.0 × 32.5 × 45.0cm	N/A	BLA	1
5087	Lined Bag for 5083	38.0 × 32.5 × 35.0cm	N/A	BLA	1



## GRANDMAID® CLEANING CARTS

### PRODUCT FEATURES:

1. An ideal solution for collecting trash and transporting cleaning tools to effectively increase cleaning efficiency.
2. Smooth surface for easy cleaning.
3. Zipped waste bags assist in emptying of waste.
4. 20cm non-marking wheels and 10cm non-marking castors enhance maneuverability.
5. A complete system solution with integrated holders for various tools to cater for your cleaning.



For storage of dustpan with a short handle



Holder for screwdrivers, pliers and other tools



Elastic clamp can hold broom and mop handles with diameter 2.2 to 2.9 cm



Holder for safety signs

Model	Description	Dimensions	Capacity	Color	Pack
5011	GRANDMAID® Cleaning Cart	116.8 × 55.2 × 97.5cm	N/A	BLA, PLAT	1



Zipped waste bags assist in emptying of waste



Four accessory bags on both sides of the bag for holding of cleaning tools



Suitable for cleaning storage, e.g. tissue paper and detergent; drawers can be opened from two directions

## ACCESSORIES



The **cover (5012)** helps contain odors and prevents flies from entering



**Spray bottle stack (5013)** is suitable for spray bottle storage



**Storage cabinet (5014)** can carry sharp cleaning tools, such as scraper, blade etc., effectively reducing the risk of injury



**Lockable top cover (5015)** safely manage detergent and other chemicals



**Garbage classification fixed frame (5016)**, convenient for garbage classification management



**Small garbage bag (5018)**, convenient for garbage classification management



**Square bucket (5264)** enables sorting of cleaning tools



**Cleaning bucket (5267)** classifies cleaning items and reduces the risk of cross infection



**Lockable doors (5019)** keeps cleaning supplies concealed



**Drawers (5266)** allows convenient and safe storage of cleaning supplies



**Cleaning tool brackets (5017)** offer storage space for mops and other cleaning tools



**Tool boxes (5268)** with built-in compartments offer exceptional storage space for various cleaning supplies



Model	Description	Dimensions	Capacity	Color	Pack
5010	Clip for Handle	7.6 × 11.5 × 4.4cm	N/A	BLA, PLAT	6
5012	Trash Bag Cover, for 5011	46.8 × 32.3 × 3.9cm	N/A	BLA, PLAT	2
5013	Spray Bottle Stack	42.5 × 12.0 × 6.5cm	N/A	BLA	2
5014	Storage Cover, for 5011	46.8 × 32.3 × 4.4cm	N/A	BLA, PLAT	1
5015	Lockable Top Cover, for 5011	46.5 × 35.0 × 41.0cm	N/A	BLA, PLAT	1
5016	Garbage Classification Fixed Frame	45.4 × 28.1 × 4.1cm	N/A	BLA	1
5018	Small Garbage Bag	43.0 × 62.0 × 9.0cm	N/A	BLUE	6
5264	Quadrate Bucket	35.8 × 21.8 × 20.5cm	N/A	YEL, BLA	6
5267	Cleaning Bucket (4 colors per set)	21.3 × 17.7 × 21.5cm	N/A	N/A	1
6971	Zippered Trash Bag, for 5011	43.8 × 26.7 × 77.5cm	N/A	YEL	2
6978	Polyliner with Side Bag, for 5011	43.8 × 26.7 × 77.5cm	N/A	BLUE, YEL, GRN, RED	2
5019	Locking Door Kit for 5011	54.0 × 39.7 × 29.4cm	N/A	YEL, BLA	1
5266	Drawer	48.5 × 25.7 × 26.0cm	N/A	YEL, BLA	2
5017	Cleaning Tool Bracket	27.6 × 12.9 × 12.0cm	N/A	BLA	6
5268	Tool Box	57.6 × 36.5 × 28.9cm	N/A	YEL, GRAY	1

# CLEANING CART COMBINATION



## SVELTE® RIM CADDIES AND DOLLIES



### PRODUCT FEATURES:

1. The combined cleaning system is composed of Svelte® trolley, Svelte® trash can and Svelte® tool assembly rack, which is convenient and efficient for collecting garbage and carrying cleaning tools.
2. The slim rectangle shape is space efficient and suitable for tight spaces.
3. Convenient for sorting collection.
4. Svelte® Dollies (1825) offer sturdy structural foam construction that won't rust, dent, chip, or peel; 7.5cm non-marking castors reduce the post-job clean-up.
5. When used with the connection device (1826), the two trolleys can be firmly connected together to improve working efficiency.



1824/1213/1825



1825



**Rim Caddies (1824)** holds a safety sign



**Rim Caddies (1824)** can secure two garbage bags on the rim for efficient classification collection



**Rim Caddies (1824)** elastic clamp can hold broom and mop handles with diameter 2.2 to 2.9cm



**Dolly Connectors (1826)** connects several dollies together for collection and transportation purposes

Model	Description	Dimensions	Capacity	Color	Pack
1213	SVELTE® Container	57.0 × 27.2 × 75.6cm	87L	BLA, LGRAY	4
1220	SVELTE® Container	51.3 × 27.2 × 75.6cm	87L	BLA, LGRAY	4
1814	SVELTE® Dolly for 1211/1213	51.6 × 29.0 × 26.0cm	N/A	BLA	2
1824	SVELTE® Rim Caddy for 1211/1213/1220	74.6 × 37.6 × 11.9cm	N/A	YEL, BLA	1
1825	SVELTE® Dolly for 1211/1213/1220	63.5 × 30.0 × 24.6cm	N/A	BLA	2
1826	SVELTE® Connector for 1825	15.9 × 10.9 × 11.4cm	N/A	BLA	1

## SVELTE® CADDY BAGS

### PRODUCT FEATURES:

1. Nylon reinforced vinyl bags are durable and easy to keep clean.
2. Includes pockets of various sizes to place cleaning supplies.
3. Used together with Svelte® trash can and Svelte® trolley (1814, 1825), it is convenient and efficient to collect garbage and carry cleaning tools.

## SVELTE® HOOKS

### PRODUCT FEATURES:

1. Tightening lock on the brim of Rim Caddies (1824).
2. Suitable for hanging all kinds of cleaning tools.
3. Made of sturdy, durable plastics.



1827



1828/1213/1825

Model	Description	Dimensions	Capacity	Color	Pack
1827	SVELTE® Hook for 1824	4.3 × 3.6 × 4.2cm	N/A	YEL, BLA	4
1828	SVELTE® Caddy Bag for 1213	50.0 × 48.0cm	N/A	YEL, BLA	2

## THOR® RIM CADDIES

### PRODUCT FEATURES:

1. Snaps securely onto rim of 166L round container (1014).
2. Built-in straps allow for easy polyliner attachment.
3. User-friendly handle improves maneuverability and minimizes contact with refuse.
4. Provides storage for spray bottles, safety signs, cleaning sponges, lobby dust pan, brushes, liners, gloves etc.
5. Made of tough and durable plastic.
6. Smooth surfaces allow for easy cleaning.



1821



1014/1821/1811



Model	Description	Dimensions	Capacity	Color	Pack
1014	THOR® Round Container	61.0 × 80.0cm	166L	GRAY	4
1811	THOR® Dolly for 1010/1012/1013/1014/1015	46.4 × 16.8cm	N/A	BLA	2
1821	THOR® Rim Caddy for 1014	88.2 × 70.3 × 17.0cm	N/A	YEL	1

## THOR® CADDY BAGS

### PRODUCT FEATURES:

1. Nylon reinforced vinyl bags are durable and easy to keep clean.
2. Pockets of various sizes for placing cleaning supplies.



1014/1831/1811

Model	Description	Dimensions	Capacity	Color	Pack
1831	THOR® Caddy Bag for 1013/1014	Dia 50.8 × 52.1cm	N/A	YEL	6

## CARRY CADDIES

### PRODUCT FEATURES:

1. Perfect for carrying tools or cleaning supplies.
2. Securely attaches to the brim of the 121L (1013) Round Container.
3. User-friendly handle fits your hand and provides a comfortable grip.
4. Securely holds Spray Bottles (6947) and other common cleaning tools.
5. Allows for stable stacking to save space.
6. Rounded corners ensure safety and prevent injury.



1823

Model	Description	Dimensions	Capacity	Color	Pack
1823	Carry Caddy	37.5 x 32.0 x 18.0cm	N/A	BLA	4

## SIGNBOARD HOOKS

### PRODUCT FEATURES:

1. An ideal solution for hanging Floor Safety Signs (7114, 7161, 7162, 7163).
2. Tightening lock on the brim of 121L Round Container (1013).
3. Made of sturdy, durable plastics.



1822

Model	Description	Dimensions	Capacity	Color	Pack
1822	Signboard Hook	15.3 x 10.0 x 6.0cm	N/A	BLA	6



## COLLAPSIBLE LINEN CARTS

### PRODUCT FEATURES:

1. Suitable for collecting and transporting all kinds of guest room linen or waste.
2. Compact, collapsible frame reduces space by 73% to enable efficient storage and transport.
3. Durable, lightweight add ease control.
4. Non-marking swivel castors allow easy to control in narrow spaces, providing quiet operation and protecting floors from damage.
5. Corner bumpers available to protect walls and equipment.
6. Durable powder-coated steel frame.
7. Sturdy and durable vinyl bag, easy to clean.
8. Specially designed trailer function can connect multiple carts together for efficient transportation.
9. Cover is sold separately.



Trailer function can connect multiple carts together for efficient transportation.

## COVER

### PRODUCT FEATURES:

1. High quality vinyl cover, easy to clean.
2. Built-in storage bag allows convenient storage of cleaning tools.
3. Zipper on the top provides easy access to the items inside without removing the cover.



Model	Description	Dimensions	Capacity	Color	Pack
5045	Classification Linen Cart	76.7 × 64.2 × 82.0cm	200L	GRAY	1
5046	Classification Linen Cart	94.2 × 64.2 × 82.0cm	240L	GRAY	1
5047	Cloth/Straw Bag, for 5045	33.0 × 51.0 × 60.0cm	100L	BLA	2
5048	Cloth/Straw Bag, for 5046	39.5 × 51.0 × 60.0cm	120L	BLA	2
5088	Collapsible Linen Cart	65.2 × 53.8 × 82.0cm	120L	GRAY	1
5089	Collapsible Linen Cart	76.7 × 64.2 × 82.0cm	200L	GRAY	1
5090	Collapsible Linen Cart	94.2 × 64.2 × 82.0cm	240L	GRAY	1
5091	Cloth/Straw Bag, for 5088	52.0 × 40.0 × 60.0cm	120L	BLA	2
5092	Cloth/Straw Bag, for 5089	67.0 × 51.0 × 60.0cm	200L	BLA	2
5093	Cloth/Straw Bag, for 5090	80.2 × 51.0 × 60.0cm	240L	BLA	2
5094	Cover for 5088	56.0 × 45.0 × 23.0cm	N/A	BLA	2
5097	Cover for 5045/5089	68.0 × 55.0 × 23.0cm	N/A	BLA	2
5098	Cover for 5046/5090	85.0 × 55.0 × 23.0cm	N/A	BLA	2

# CLEANING CART COMBINATION

## X TYPE LINEN CARTS

### PRODUCT FEATURES:

1. Fit for collecting all kinds of linen.
2. Durable, lightweight and easy to control.
3. High quality canvas bag with side straps for easy access.
4. Fold to save space and make storage and transportation easier.
5. 5095 and 5096 storage bags used with linen cart are convenient for carrying cleaning supplies. (Refer to image on next page.)



5041

5042

Model	Description	Dimensions	Capacity	Color	Pack
5041	X Type Linen Cart	70.5 × 63.5 × 87.6cm	170L	GRAY	1
5042	X Type Linen Cart	94.0 × 66.0 × 101.0cm	340L	GRAY	1
5043	Cloth/Straw Bag for 5041	65.5 × 58.5 × 67.5cm	170L	BRN	2
5044	Cloth/Straw Bag for 5042	84.0 × 58.5 × 86.0cm	340L	BRN	2
5095	Fabric Hanging Organizers for 5041	64.0 × 68.5 × 3.0cm	N/A	BRN	2
5096	Fabric Hanging Organizers for 5042	80.5 × 85.0 × 3.0cm	N/A	BRN	2

Combine the accessories with your **THOR®** or **SVELTE®** CONTAINERS to turn the container into a mini cleaning cart that suit your need.





# MOPPING SYSTEMS



## ALL-IN-ONE BUCKETS

### PRODUCT FEATURES:

1. An easy-to-maneuver mopping system, compact and powerful, carries all your needs for wet mopping and light cleaning.
2. Durable wringer designed for wringing over 25, 000 times.
3. Ergonomically designed handle fit your hands and height, and reduce the need for bending.
4. Non-marking all-plastic wheels reduce post-job clean-up.
5. A discharge valve is available at the bottom of bucket to allow for emptying of dirty water without lifting.
6. A caddy is available to carry small cleaning tools which can be removed when not needed.
7. Build-in hook to hang Safety Signs.
8. Multi colors are available to reduce cross-contamination between work areas.



5211



**Non-marking all-plastic wheels** reduce post-job clean-up



A **caddy** is available to carry small cleaning tools which can be removed when not needed

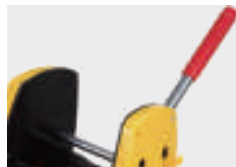

Ergonomically designed **handle** fit your hands and height, and reduce the need for bending



Comfortable **hand grip** assists in lifting and emptying dirty water



A **discharge valve** is available at the bottom of bucket to allow for emptying of dirty water without lifting



Has **capacity to carry additional caddy** (5262) at the rear for cleaning tools

Model	Description	Dimensions	Capacity	Color	Pack
5210	Wringer for 5211	34.1 x 44.2 x 49.0cm	N/A	BLUE, GRN, RED, YEL	1
5211	All-in-one Bucket	67.3 x 38.1 x 88.4cm	25L	BLUE, GRN, RED, YEL	1
5262	Bucket for 5211	15.2 x 20.3 x 30.5cm	3L	BLUE, GRN, RED, YEL	2

# GRANDMAID® SIDE PRESS COMBOS

## PRODUCT FEATURES:

1. The anti-splash mop bucket and wringer system reduces splashing providing a safer environment, cleaner floors, and improved productivity.
2. High-efficiency wringer, wrings mop with 18% less effort.
3. Lasts 58 times longer than generic wringers.
4. Made of premium tubular steel and structural web molded plastic to ensure higher durability and toughness.
5. Ergonomically designed handle fit your hands and height, and reduce the need for bending.
6. Non-marking all-plastic wheels reduce post-job clean-up.
7. Optional dirty water bucket separates dirty water from the cleaning solution.



Comfortable **hand grip** assists in lifting and emptying dirty water

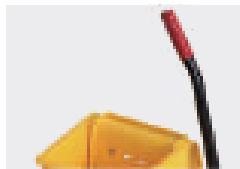

Ergonomically designed **handle** fit your hands and height, and reduce the need for bending



### Dirty Water Bucket

1. Keeps the dirty water from clean water.
2. Maintains the cleaning capability of cleanser.
3. Minimizes the consumption of water and chemical.
4. Brings you cleaner floor.
5. Divides the liquid to reduce the bucket weight for lifting and assist in emptying.



**7.5cm non-marking all-plastic wheel**



5221



5222



5225



5224

Model	Description	Dimensions	Capacity	Color	Pack
5221	GRANDMAID® Bucket with Kits	63.3 × 39.2 × 42.5cm	33L	BLUE, GRN, RED, YEL, BRN	4
5222	GRANDMAID® Side Press Wringer for 5221	56.0 × 40.5 × 95.0cm	N/A	BLUE, GRN, RED, YEL, BRN	2
5223	GRANDMAID® Side Press Combo	63.3 × 39.2 × 94.5cm	33L	YEL, BRN	1
5224	GRANDMAID® Bucket with Kits	51.1 × 40.6 × 44.2cm	33L	BLUE, GRN, RED, YEL, BRN	4
5225	GRANDMAID® Side Press Wringer for 5224/5229	33.0 × 33.0 × 68.6cm	N/A	BLUE, GRN, RED, YEL, BRN	2
5226	GRANDMAID® Side Press Combo	51.5 × 40.6 × 92.7cm	33L	BLUE, GRN, RED, YEL, BRN	1
5229	GRANDMAID® Bucket with Kits	49.5 × 37.2 × 42.4cm	25L	YEL	4
5261	Dirty Water Bucket for 5221/5223	56.0 × 40.5 × 29.5cm	17L	RED, YEL	2
5263	Dirty Water Bucket for 5224/5226/5228	35.8 × 25.1 × 35.8cm	17L	RED, YEL	2
5300	GRANDMAID® Side Press Combo	50.0 × 37.2 × 90.0cm	25L	YEL	1



## GRANDMAID® DOWN PRESS COMBOS

### PRODUCT FEATURES:

1. The anti-splash mop bucket and wringer system reduces splashing providing a safer environment, cleaner floors, and improved productivity.
2. High-efficiency wringer, wrings mop with 18% less effort.
3. Lasts 58 times longer than generic wringers.
4. Made of premium tubular steel and structural web molded plastic to ensure higher durability and toughness.
5. Ergonomically designed handle fit your hands and height, and reduce the need for bending.
6. Non-marking all-plastic wheels reduce post-job clean-up.
7. Optional dirty water bucket separates dirty water from the cleaning solution.



5228



Ergonomically designed **handle** fit your hands and height, and reduce the need for bending



#### Dirty Water Bucket

1. Keeps the dirty water from clean water.
2. Maintains the cleaning capability of cleanser.
3. Minimizes the consumption of water and chemical.
4. Brings you cleaner floor.
5. Divides the liquid to reduce the bucket weight for lifting and assist in emptying.

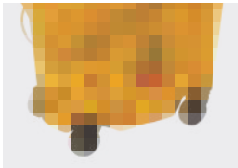

**7.5cm non-marking all-plastic wheel**



5224



5227

### WET MOPS GUIDE

The down press wringer is suitable for mops with headband length less than 10cm, such as 6064/6072/6073.

Model	Description	Dimensions	Capacity	Color	Pack
5224	GRANDMAID® Bucket with Kits	51.1 × 40.6 × 44.2cm	33L	BLUE, GRN, RED, YEL, BRN	4
5227	GRANDMAID® Down Press Wringer for 5224/5229	34.3 × 33.5 × 68.6cm	N/A	BLUE, GRN, RED, YEL, BRN	2
5228	GRANDMAID® Down Press Combo	51.5 × 40.6 × 92.7cm	33L	YEL, BRN	1
5229	GRANDMAID® Bucket with Kits	49.5 × 37.2 × 42.4cm	25L	YEL	4
5263	Dirty Water Bucket for 5224/5226/5228	35.8 × 25.1 × 35.8cm	17L	RED, YEL	2
5301	GRANDMAID® Down Press Combo	50.0 × 37.2 × 90.0cm	25L	YEL	1

## GRANDMAID® DUAL WATER MOPPING COMBOS

### PRODUCT FEATURES:

1. The anti-splash mop bucket and wringer system reduces splashing providing a safer environment, cleaner floors, and improved productivity.
2. High-efficiency wringer, wrings mop with 18% less effort.
3. Lasts 58 times longer than generic wringers.
4. Made of premium tubular steel and structural web molded plastic to ensure higher durability and toughness.
5. Ergonomically designed handle fit your hands and height, and reduce the need for bending.
6. Non-marking all-plastic wheels reduce post-job clean-up.
7. A bucket included to separate clean and dirty water.
8. Double luxury model can improve the image and increase the stability.



5311

5312

Model	Description	Dimensions	Capacity	Color	Pack
5311	GRANDMAID® Dual Water Side Press Combo	56.9 × 41.9 × 98.0cm	33L	YEL	1
5312	GRANDMAID® Dual Water Down Press Combo	56.9 × 41.9 × 98.0cm	33L	YEL	1

## GRANDMAID® MOPPING SYSTEM ACCESSORIES

### PRODUCT FEATURES:

1. Various accessories available to solve problems and reduce cost.
2. Complete mop solutions to improve efficiency.



5310

5224

5263

5225

5227

Model	Description	Dimensions	Capacity	Color	Pack
GRANDMAID® BUCKETS WITH KITS					
5221	GRANDMAID® Bucket with Kits	63.3 × 39.2 × 42.5cm	33L	BLUE, GRN, RED, YEL, BRN	4
5224	GRANDMAID® Bucket with Kits	51.1 × 40.6 × 44.2cm	33L	BLUE, GRN, RED, YEL, BRN	4
5229	GRANDMAID® Bucket with Kits	49.5 × 37.2 × 42.4cm	25L	YEL	4
GRANDMAID® WRINGERS					
5222	GRANDMAID® Side Press Wringer for 5221	56.0 × 40.5 × 95.0cm	N/A	BLUE, GRN, RED, YEL, BRN	2
5225	GRANDMAID® Side Press Wringer for 5224/5229	33.0 × 33.0 × 68.6cm	N/A	BLUE, GRN, RED, YEL, BRN	2
5227	GRANDMAID® Down Press Wringer for 5224/5229	34.3 × 33.5 × 68.6cm	N/A	BLUE, GRN, RED, YEL, BRN	2
ACCESSORIES					
5261	Dirty Water Bucket for 5221/5223	56.0 × 40.5 × 29.5cm	17L	RED, YEL	2
5263	Dirty Water Bucket for 5224/5226/5228	35.8 × 25.1 × 35.8cm	17L	RED, YEL	2
5310	Quiet Castor Dolly	51.8 × 41.5 × 16.8cm	N/A	BLA	1

## PEDAL MOP WRINGERS

### PRODUCT FEATURES:

1. Heavy-duty iron bucket with reinforced base.
2. Sturdy construction from heavy-duty galvanized sheets for an extended service life.
3. Comes with base castors for easy mobility and maneuverability.
4. No need for bending or hand-wringing.
5. Copper roller is durable and rust resistant.



Copper roller is durable and rust resistant



Comes with base castors for easy mobility and maneuverability



5281

Model	Description	Dimensions	Capacity	Color	Pack
5281	Pedal Mop Wringer	47.5 × 28.5 × 37.0cm	15L	MSILV	1

## PAIL AND MOP STRAINER COMBINATIONS

### PRODUCT FEATURES:

1. Lightweight and easy to clean, helps to improve operator productivity.
2. Pail holds up to 14L. Strainer fits for a small mop.
3. Comfortable plastic handle for lifting the pail.
4. Durable plastic construction has smooth, easy-to-clean surface.
5. Pails and mop strainers nest and stack for convenient transport and storage between jobs.
6. Bottom hand-holds assist in emptying.



5231



5271

Model	Description	Dimensions	Capacity	Color	Pack
5231	Pail and Mop Strainer Combination	43.0 × 31.2 × 31.6cm	14L	GRAY	6
5271	Cotton Mop and Handle Combination	150.0cm	N/A	WHT	4
5272	Replacement Mop for 5271	20.0cm	N/A	WHT	12

## DOUBLE PAILS

### PRODUCT FEATURES:

1. Strong and durable.
2. Includes graduations for accurate measuring.
3. Comfortable plastic handle for easy lifting of the pail.
4. Separates the clean water from the dirty water.
5. Allows for stable stacking to save space.



5241



5242

Model	Description	Dimensions	Capacity	Color	Pack
5241	Double Pails	38.2 × 35.4 × 25.2cm	16L	GRAY	6
5242	Double Pails	45.6 × 36.8 × 27.0cm	18L	GRAY	6

## STEEL SPONGE MOPS

### PRODUCT FEATURES:

1. Front-pull lever on the mop handle allows for squeeze-action wringing.
2. Mop head is replaceable.



5273



5275

Model	Description	Dimensions	Capacity	Color	Pack
5273	Steel Sponge Mop with Cellulose Head	27.0 × 12.5 × 140.0cm	N/A	BLUE	6
5274	Steel Cellulose Replacement Head	27.0cm	N/A	VEL	12
5275	PVA Sponge Mop	27.0 × 6.5 × 130.0cm	N/A	BLA	4
5276	PVA Sponge Mop Refill	27.0cm	N/A	N/A	12



## ROUND BUCKETS



### PRODUCT FEATURES:

1. Heavy-duty thick wall construction ensures durability and toughness.
2. Graduations on round shape ensure accurate measuring and increase efficiency.
3. Easy to lift the bucket with a comfortable plastic handle.
4. Bottom hand-hold assists in emptying.
5. Allows for stable stacking to save space.



5251



5252



5253



5254

Model	Description	Dimensions	Capacity	Color	Pack
5251	Round Bucket	26.7 × 26.0cm	10L	BLUE, GRAY, GRN, RED, YEL, WHT	12
5252	Round Bucket	30.5 × 28.6cm	13L	BLUE, GRAY, GRN, RED, YEL, WHT	6
5253	Round Bucket	26.0 × 24.0cm	9L	BLUE, GRAY, GRN, RED, YEL	12
5254	Round Bucket	28.0 × 26.0cm	12L	BLUE, GRAY, GRN, RED, YEL	6

## QUADRATE BUCKET



### PRODUCT FEATURES:

1. Strong and durable.
2. Works with Cleaning Cart (5011) to enhance cleaning efficiency.
3. User-friendly handle provides a comfortable grip.
4. Allows for stable stacking to save space.
5. Quadrate Bucket (5264) can store Spray Bottle (6947) and classified storage cleaning accessories.



5264



5265

Model	Description	Dimensions	Capacity	Color	Pack
5264	Quadrate Bucket	35.8 × 21.8 × 20.5cm	9.5L	BLUE, GRN, RED, YEL, BLA	6
5265	Quadrate Bucket	21.3 × 17.7 × 21.5cm	4.7L	BLUE, GRN, RED, YEL	6



# WET MOPS



## WET MOP SELECTION GUIDE

### WET MOPS

Various criteria can apply when selecting the correct wet mop. Please follow the selection guide given here to select the best wet mop for your floor maintenance.

#### Mops for General Cleaning

Mops with excellent absorbency, easy water release and high durability are preferred. If conditions permit, washable mops are your best choice. Synthetic yarn, rayon and blend mops with looped-end and tailbanded are most washable and provide an optimized performance.

#### Finish Mops

Mops with excellent absorbency, and easy water release are preferred. In addition, looped-end and tailbanded mops cover more floor area per stroke and reduce streaking.

### What is more important for you?

#### Launderability and Durability:

Launderability is the number of times a mop can be washed and dried before it is worn out. Durability is indicated by the length of time that passes before it is necessary to replace a worn mop. Mops made of microfiber, rayon and blend have the highest durability.



Microfiber Synthetic Blend Rayon

#### Absorbencies:

Absorbency means the capability to retain liquid. Higher absorbency means a shorter time to dry the floor, higher working efficiency and safer operation. Microfiber, rayon and cotton mops offer the best absorbency.



Microfiber Rayon Cotton Blend

#### Water-release Performance:

Water-release performance means the mop's capacity to release water on to the floor or during wringing. Stronger water-release performance means a shorter time is needed to wring the mop and effectively release the cleanser onto the floor. Microfiber, rayon and synthetic fiber mops have the strongest water-release capability.



Microfiber Rayon Synthetic Blend

#### Cleaning Performance:

It indicates the capability to remove dust and dirt from the floor.



Microfiber Rayon Synthetic Blend



## WET MOP SELECTION GUIDE

Category	Laundrying	Vinyl Tile, Laminate Flooring and Smooth Ceramic Tile Flooring	Floor Tiles, Terrazzo, Pavement Slab and Square Stone Slab	Rubber, Hardwood, Smooth Concrete
Health Care	Premium Washable Mops Standard Washable Mop Unwashable Disposable Mop	Microfiber Wet Mops Universal Headband Mops Cut-end Rayon Mops	Rough Floor Mops Universal Headband Mops Cut-end Cotton Mops	Microfiber Wet Mops Blend Mops Universal Headband Mops
School	Premium Washable Mops Standard Washable Mop Unwashable Disposable Mop	Microfiber Wet Mops Universal Headband Mops Economy Cotton Mops	Rough Floor Mops Universal Headband Mops Cut-end Cotton Mops	Microfiber Wet Mops Blend Mops Economy Cotton Mops
Industrial and Commercial	Premium Washable Mops Standard Washable Mop Unwashable Disposable Mop	Microfiber Wet Mops Blend Mops Cut-end Cotton Mops	Rough Floor Mops Blend Mops Cut-end Cotton Mops	Microfiber Wet Mops Blend Mops Cotton Mop without Looped Ends
Catering	Premium Washable Mops Standard Washable Mop Unwashable Disposable Mop	Microfiber Wet Mops Blend Mops Cut-end Blend Mops	Rough Floor Mops Universal Headband Mops Cut-end Cotton Mops	Microfiber Wet Mops Blend Mops Synthetic Blend Mops
Office Building	Premium Washable Mops Standard Washable Mop Unwashable Disposable Mop	Microfiber Wet Mops Blend Mops Cut-end Cotton Mops	Rough Floor Mops Universal Headband Mops Cut-end Cotton Mops	Microfiber Wet Mops Blend Mops Cut-End Cotton Mops
Hotels	Premium Washable Mops Standard Washable Mop Unwashable Disposable Mop	Microfiber Wet Mops Blend Mops Cut-end Blend Mops	Rough Floor Mops Universal Headband Mops Cut-end Cotton Mops	Microfiber Wet Mops Blend Mops Synthetic Blend Mops
Gymnasium	Premium Washable Mops Standard Washable Mop Unwashable Disposable Mop	Microfiber Wet Mops Blend Mops Cut-end Cotton Mops	Rough Floor Mops Universal Headband Mops Cut-end Cotton Mops	Microfiber Wet Mops Blend Mops Cut-End Cotton Mops
Club	Premium Washable Mops Standard Washable Mop Unwashable Disposable Mop	Microfiber Wet Mops Blend Mops Cut-end Blend Mops	Rough Floor Mops Universal Headband Mops Cut-end Cotton Mops	Microfiber Wet Mops Blend Mops Synthetic Blend Mops

## FOR CLEANING, SCRUBBING AND FINISHING

Cleaning and Scrubbing	Finish
Blend Mops	Nylon Finish Mops
Premium Mop without Looped Ends	Blend Mops
Economy Cotton Mops	Blend Mops

### PREMIUM WASHABLE MOPS:

Allow for average 75-100 laundering and re-use.

### STANDARD WASHABLE MOPS:

Allow for average 25-75 laundering and re-use.

### UNWASHABLE/DISPOSABLE MOPS:

Laundering is not suggested.

# WET MOPS

## BLEND MOPS

### PRODUCT FEATURES:

1. Outperforms and outlasts premium cut-end mops by a factor of two to one.
2. Balanced blend of cotton and synthetic yarns for higher absorbency and strength.
3. Looped ends and yarn tailbanded mops have greater floor coverage.



6013

6015

Model	Description	Mop Size	Headband Size	Headband Color	Mop Color	Pack
6013	Blend Mop	Medium	12.7cm	GRN	BLUE, GRN, RED, WHT	6
6014	Blend Mop	Large	12.7cm	RED	BLUE, GRN, RED, WHT	6
6015	Blend Mop	Medium	3.2cm	GRN	BLUE, GRN, RED, WHT	6
6016	Blend Mop	Large	3.2cm	RED	BLUE, GRN, RED, WHT	6

## COTTON MOPS

### PRODUCT FEATURES:

1. Excellent, all-purpose mop for general cleaning.
2. Looped ends reduce fraying associated with cut-end mops.



6023

6025

Model	Description	Mop Size	Headband Size	Headband Color	Mop Color	Pack
6023	Cotton Mop	Medium	12.7cm	GRN	WHT	12
6024	Cotton Mop	Large	12.7cm	RED	WHT	12
6025	Cotton Mop	Medium	3.2cm	GRN	WHT	12
6026	Cotton Mop	Large	3.2cm	RED	WHT	12

## SUPERFINE FIBER MOPS

### PRODUCT FEATURES:

1. Looped ends and yarn tailbanded mops have greater floor coverage.
2. Soft and elastic fiber won't cause the slightest damage to the cleaning surface.
3. Excellent absorbency, strong dirt-removal performance and long service life.



6033

Model	Description	Mop Size	Headband Size	Headband Color	Mop Color	Pack
6033	Superfine Fiber Mop	Medium	12.7cm	GRN	WHT	12
6034	Superfine Fiber Mop	Large	12.7cm	RED	WHT	12
6035	Superfine Fiber Mop	Medium	3.2cm	GRN	WHT	12
6036	Superfine Fiber Mop	Large	3.2cm	RED	WHT	12

## ECONOMY COTTON MOPS

### PRODUCT FEATURES:

1. Economical cut-end mops.
2. Cotton mops for various cleaning applications.



6112



6113

Model	Description	Mop Size	Headband Size	Headband Color	Mop Color	Pack
6112	Economy Cotton Mop, Small	Small	12.7cm	WHT	WHT	12
6113	Economy Cotton Mop, Small	Small	3.2cm	WHT	WHT	12

## FINISH MOPS

### PRODUCT FEATURES:

1. Suitable for floor finish application.
2. Balanced blend of cotton and synthetic yarns ensures higher absorbency and strength.
3. Bright blue and white yarn helps color code the finish mop from general-purpose mops.
4. Looped ends with yarn tailbanded ensure greater coverage with each stroke and help reduce streaking.
5. Tightly twisted, 4-ply yarn helps reduce linting.



6043

Model	Description	Mop Size	Headband Size	Headband Color	Mop Color	Pack
6043	Finish Mop	Medium	12.7cm	BLUE	BLUE/WHT	6
6044	Finish Mop	Medium	3.2cm	BLUE	BLUE/WHT	6

## CLEAN ROOM MOPS

### PRODUCT FEATURES:

1. Looped ends and yarn tailbanded mop for greater floor coverage with each stroke.
2. For use in Class 10, 000 and higher industrial applications such as paint booths, pharmaceutical labs, etc.
3. Made of a woven/rayon/polyester fabric that will not fray or lint.
4. Washable and pre-shrunk for long product life.



6053

Model	Description	Mop Size	Headband Size	Headband Color	Mop Color	Pack
6053	Clean Room Mop, Medium	Medium	12.7cm	GRN	WHT	12
6054	Clean Room Mop, Large	Large	12.7cm	RED	WHT	12
6055	Clean Room Mop, Medium	Medium	3.2cm	GRN	WHT	12
6056	Clean Room Mop, Large	Large	3.2cm	RED	WHT	12

## SUPERFINE FIBER MOPS

### PRODUCT FEATURES:

1. Quality superfine fibers effectively remove bacteria.
2. Absorbency up to ten times its weight.
3. Effectively enhances the performance of chemical cleansers.
4. Free of lint.
5. Extra-strong mildew-resistance.
6. Comes with tailbanded (6062/6063/6065/6066) to ensure greater coverage with each stroke.
7. 6064 can work in couple with (6351/6352/6353/6388) handles.



6063

6064



Innovative **yarn spinning technology** ensures excellent absorbency and strong dirt-removal

Model	Description	Mop Size	Headband Size	Headband Color	Mop Color	Pack
6062	Super Fiber Mop	Medium	12.7cm	GRN	WHT	12
6063	Super Fiber Mop	Large	12.7cm	RED	WHT	12
6064	Super Fiber Mop With Plastic Threaded Tip	Medium	5.4 × 3.8cm	BLUE	WHT	12
6065	Super Fiber Mop	Medium	3.2cm	GRN	WHT	12
6066	Super Fiber Mop	Large	3.2cm	RED	WHT	12

## MICROFIBER TUBE MOPS

### PRODUCT FEATURES:

1. Blend of microfiber and polyester.
2. More durable than traditional blend mops and can withstand three times the number of launderings than traditional blend mops.
3. Superior absorbency and release.
4. Tube shape reduces drag effectively.



6082

6084

Model	Description	Mop Size	Headband Size	Headband Color	Mop Color	Pack
6082	Microfiber Tube Mop	Medium	12.7cm	GRN	GRN	6
6083	Microfiber Tube Mop	Large	12.7cm	RED	GRN	6
6084	Microfiber Tube Mop	Medium	3.2cm	GRN	GRN	6
6085	Microfiber Tube Mop	Large	3.2cm	RED	GRN	6



## MICROFIBER STRING MOPS

### PRODUCT FEATURES:

1. Blend of microfiber and cotton.
2. Washable, resistant to shrinking.
3. More durable than traditional blend mops and can withstand twice the number of launderings than traditional blend mops.
4. Superior absorbency and release.



6092

6094

Model	Description	Mop Size	Headband Size	Headband Color	Mop Color	Pack
6092	Microfiber String Mop	Medium	12.7cm	GRN	GRN	6
6093	Microfiber String Mop	Large	12.7cm	RED	GRN	6
6094	Microfiber String Mop	Medium	3.2cm	GRN	GRN	6
6095	Microfiber String Mop	Large	3.2cm	RED	GRN	6

## QUICK CONNECT MOPS

### PRODUCT FEATURES:

1. Quick-connect mops are fit for general cleaning.
2. Quick-connect design makes assembly and replacement easier.
3. Looped-ends and yarn tailbanded mop have greater floor coverage.
4. Balanced blend of cotton and synthetic yarns for higher absorbency, efficiency and longer product life.
5. Works with wringers (5211/5223/5226).
6. Optional handles (6413/6414) available, which are sold separately.



6072

Model	Description	Mop Size	Headband Size	Headband Color	Mop Color	Pack
6072	Quick Connect Mop	Medium	N/A	N/A	BLUE, GRN, RED, WHT	24
6073	Quick Connect Mop	Large	N/A	N/A	BLUE, GRN, RED, WHT	24



## SYNTHETIC FIBER MOPS

### PRODUCT FEATURES:

1. Synthetic fiber for excellent water absorption and a long service life.
2. Looped-ends and yarn tailbanded mops have greater floor coverage.



6133



6135

Model	Description	Mop Size	Headband Size	Headband Color	Mop Color	Pack
6133	Synthetic Fiber Mop	Medium	12.7cm	GRN	BLUE , GRN, RED, WHT	6
6134	Synthetic Fiber Mop	Large	12.7cm	RED	BLUE , GRN, RED, WHT	6
6135	Synthetic Fiber Mop	Medium	3.2cm	GRN	BLUE , GRN, RED, WHT	6
6136	Synthetic Fiber Mop	Large	3.2cm	RED	BLUE , GRN, RED, WHT	6

## ANTIBIOTIC BLENDED MOPS

### PRODUCT FEATURES:

1. Integrated antibiotic protection effectively inhibits the growth of bacteria, prevents odors and extends life cycle.
2. Made of a blend of polyester, antibiotic acrylic fibers and cotton.
3. Very moisture-absorbing, durable and effective cleaning.
4. Washable, resistant to shrinking.
5. Looped ends and yarn tailbanded mop for greater floor coverage with each stroke.



6103



6105

Model	Description	Mop Size	Headband Size	Headband Color	Mop Color	Pack
6103	Antibiotic Blended Mop	Medium	12.7cm	GRN	GRN	6
6104	Antibiotic Blended Mop	Large	12.7cm	RED	GRN	6
6105	Antibiotic Blended Mop	Medium	3.2cm	GRN	GRN	6
6106	Antibiotic Blended Mop	Large	3.2cm	RED	GRN	6

## ANTIBIOTIC MICROFIBER MOPS

### PRODUCT FEATURES:

1. Integrated antibiotic protection inhibits the growth of bacteria, prevents odors and extends life cycle.
2. Blended polyester-nylon composite yarns and antibiotic acrylic fibers.
3. Very moisture-absorbing, durable and effective cleaning.
4. Washable, resistant to shrinking.
5. Looped ends and yarn tailbanded mop for greater floor coverage with each stroke.



6123



6125

Model	Description	Mop Size	Headband Size	Headband Color	Mop Color	Pack
6123	Antibiotic Microfiber Mop	Medium	12.7cm	GRN	GRN	6
6124	Antibiotic Microfiber Mop	Large	12.7cm	RED	GRN	6
6125	Antibiotic Microfiber Mop	Medium	3.2cm	GRN	GRN	6
6126	Antibiotic Microfiber Mop	Large	3.2cm	RED	GRN	6



# WET MOP HANDLES



## SIDE GATE MOP HANDLES

### PRODUCT FEATURES:

1. Large plastic mop head and threaded-tight structure ensures that the mop is held securely in place.
2. The handle is made from light and durable high-performance composite material.
3. Patented design allows for easy mop replacement.
4. Suitable for mops with headband size of 3.2cm.



6311



Model	Description	Dimensions	Capacity	Color	Pack
6311	Side Gate Mop Handle	137.0cm	N/A	BLUE, GRAY, GRN, RED, YEL	12
6312	Side Gate Mop Handle	152.0cm	N/A	BLUE, GRAY, GRN, RED, YEL	12
6313	Side Gate Mop Handle	137.0cm	N/A	LAC	12
6314	Side Gate Mop Handle	152.0cm	N/A	LAC	12
6315	Side Gate Mop Handle	137.0cm	N/A	MSILV	12
6316	Side Gate Mop Handle	152.0cm	N/A	MSILV	12

## CLAMP STYLE MOP HANDLES

### PRODUCT FEATURES:

1. Threaded-tight structure ensures that the mop is held securely in place..
2. The handle is made from light and durable high-performance composite material.
3. Threaded-bolt head for quick and easy mop changes.
4. Suitable for mops with headband size of 12.7cm.



6321



Model	Description	Dimensions	Capacity	Color	Pack
6321	Clamp Style Mop Handle	137.0cm	N/A	BLUE, GRAY, GRN, RED, YEL	12
6322	Clamp Style Mop Handle	137.0cm	N/A	BLUE, GRAY, GRN, RED, YEL	12
6323	Clamp Style Mop Handle	152.0cm	N/A	BLUE, GRAY, GRN, RED, YEL	12
6324	Clamp Style Mop Handle	152.0cm	N/A	BLUE, GRAY, GRN, RED, YEL	12
6325	Clamp Style Mop Handle	137.0cm	N/A	LAC	12
6326	Clamp Style Mop Handle	152.0cm	N/A	LAC	12
6327	Clamp Style Mop Handle	137.0cm	N/A	MSILV	12
6328	Clamp Style Mop Handle	152.0cm	N/A	MSILV	12

## HINGED SIDE GATE MOP HANDLES

### PRODUCT FEATURES:

1. Thumb release mechanism permits mop replacement without touching the dirty mop.
2. The handle is made from light and durable high-performance composite material.
3. Suitable for mops with headband size of 3.2cm.



6331



Thumb release mechanism permits mop replacement without touching dirty mop

Model	Description	Dimensions	Capacity	Color	Pack
6331	Hinged Side Gate Mop Handle	137.0cm	N/A	BLUE	12
6332	Hinged Side Gate Mop Handle	152.0cm	N/A	BLUE	12

## STEEL MOP HANDLES

### PRODUCT FEATURES:

1. Durable corrosion-resistant metal head.
2. 137cm and 152cm lengths optional.
3. Suitable for mops with headband size of 3.2cm.



6341

Model	Description	Dimensions	Capacity	Color	Pack
6341	Steel Mop Handle, Hardwood Handle	137.0cm	N/A	LAC	12
6342	Steel Mop Handle, Hardwood Handle	152.0cm	N/A	LAC	12

## NAELC® ALUMINUM QUICK CONNECT HANDLES



### PRODUCT FEATURES:

1. Lightweight aluminum construction enhances cleaning efficiency.
2. Quick-connect design makes assembly and replacement easier.
3. Ergonomically designed handles are comfortable and easily maneuverable.
4. 6415 can be used with TRUST threaded tools.

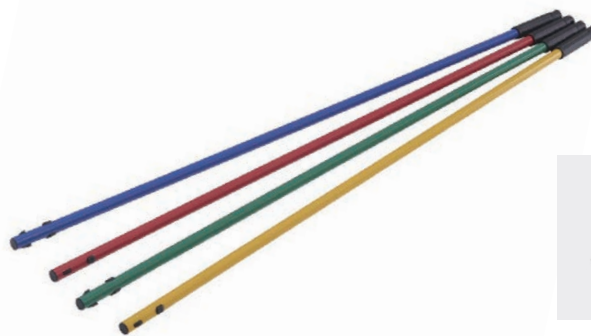

6413



Quick-connect Adapter (6415) can be used with TRUST threaded tools

Model	Description	Dimensions	Capacity	Color	Pack
6413	NAELC® Aluminum Quick Connect Handle	132.0cm	N/A	BLUE, GRAY, GRN, RED, YEL	12
6414	NAELC® Aluminum Quick Connect Handle	147.0cm	N/A	BLUE, GRN, RED, YEL	12
6415	Quick-connect Adapter	3.3 x 9.5cm	N/A	BLA	3



## DUST MOP SELECTION GUIDE

### SELECTING THE BEST CLEANING TOOLS FOR YOUR FACILITY:

The guide below provides some key factors to consider when selecting the most suitable dust mop for your floor.

Facility	Best	Better	Good
Hotels	Microfiber Dust Mop	Synthetic Dust Mop	Blended Dust Mop
Catering	Microfiber Dust Mop	Synthetic Dust Mop	Blended Dust Mop
Health Care	Microfiber Dust Mop	Blended Dust Mop	Synthetic Dust Mop
Industrial and Commercial	Microfiber Dust Mop	Synthetic Dust Mop	Blended Dust Mop
School	Microfiber Dust Mop	Synthetic Dust Mop	Synthetic Dust Mop
Office Building	Microfiber Dust Mop	Synthetic Dust Mop	Blended Dust Mop

### GENERAL DUST MOPPING:

Durable dust mops with high dust pick-up capacity are preferred. If permitted, washable dust mops are the most cost-efficient choice. Twisted loop mops, reinforced stitching and easily attachable backing units are factors that contribute to superior cleaning and performance.



#### TWISTED LOOP END

For optimal cleaning of dust and dirt. Twisted loops resist snagging, fraying or unravelling while laundering.

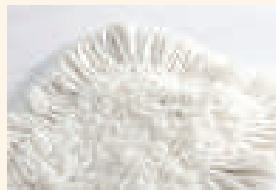

#### CUT ENDS

Economical construction for general purpose dusting.



#### REINFORCED STITCHING

Add reinforced stitching on easily-wearing parts for extended service life.



#### BACKING DESIGN

Backing for easy attaching and detaching from the frame helps improve cleaning efficiency.

### LAUNDERABILITY

Laundryability is the number of times a dust mop can be laundered and dried before it becomes worn out, or is under-performing.

Synthetic and blended dust mops have the highest laundryability.

### DURABILITY

Durability is indicated by the length of time that passes before it is necessary to replace a worn dust mop.

Synthetic and blended Mops have the highest durability.

Antimicrobial fiber mops are more durable thanks to their capability to inhibit the growth of bacteria, reduce odor and prevent fading.

### DUST PICK UP

Dust Pick-up Performance means the mop's capacity to pick up dirt and dust from the floor.

Microfiber dust mops have the best dust pick-up performance.

## NAELC® QUICK CONNECT HANDLES

### PRODUCT FEATURES:

1. Lightweight aluminum construction.
2. Telescopic handle for cleaning high places.
3. 6415 can be used with TRUST threaded tools.



Quick-connect Adapter (6415) can be used with TRUST threaded tools



Model	Description	Dimensions	Capacity	Color	Pack
6411	NAELC® 51.0-102.0cm Quick-connect Short Extension Handle	Open: 102.0 × 5.1 × 5.1cm Closed: 68.0 × 5.1 × 5.1cm	N/A	YEL	6
6412	NAELC® 122.0-183.0cm Quick-connect Straight Extension Handle	Open: 183.0 × 5.1 × 5.1cm Closed: 132.0 × 5.1 × 5.1cm	N/A	YEL	6
6416	NAELC® 122.0-235.0cm Quick-connect Straight Extension Handle	Open: 235.0 × 5.3 × 5.3cm Closed: 122.0 × 5.3 × 5.3cm	N/A	YEL	6
6417	NAELC® 180.0-360.0cm Quick-connect Straight Extension Handle	Open: 360.0 × 5.3 × 5.3cm Closed: 180.0 × 5.3 × 5.3cm	N/A	YEL	6
6415	Quick-connect Adapter	3.3 × 9.5cm	N/A	BLA	3

## NAELC® QUICK CONNECT FRAMES

### PRODUCT FEATURES:

1. Lightweight aluminum construction.
2. Designed with a round plastic cover on both ends to protect walls and furniture.



Model	Description	Dimensions	Capacity	Color	Pack
6420	NAELC® 28.0cm Quick-connect Wall/Stair Frame	28.0 × 8.9 × 3.8cm	N/A	BLA	6
6421	NAELC® 46.0cm Quick-connect Frame	46.0 × 8.9 × 3.8cm	N/A	BLA	6
6422	NAELC® 61.0cm Quick-connect Frame	61.2 × 8.9 × 3.8cm	N/A	BLA	6
6423	NAELC® 91.0cm Quick-connect Frame	91.7 × 8.9 × 3.8cm	N/A	BLA	6
6424	NAELC® 122.0cm Quick-connect Frame	122.2 × 8.9 × 3.8cm	N/A	BLA	6
6425	NAELC® 152.0cm Quick-connect Frame	152.4 × 8.9 × 3.8cm	N/A	BLA	6

# DUST MOPS

## NAELC® DUST MOPS

### PRODUCT FEATURES:

1. High cleaning performance.
2. Looped end construction increases the cleaning coverage and reduces linting.
3. Foam-like edge and 5cm-long fringe help remove large amounts of dust and dirt.
4. Fully washable in water up to 93°C.

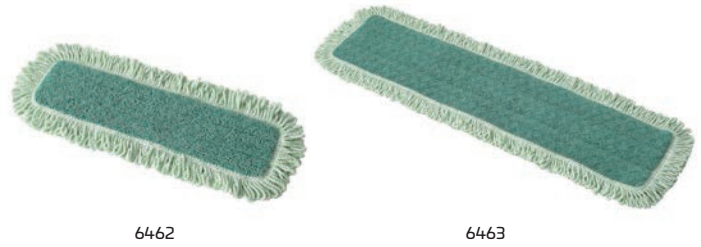

Model	Description	Dimensions	Capacity	Color	Pack
6461	NAELC® 46.0cm Microfiber Fringed Dust Mop	54.5 × 22.9 × 1.3cm	N/A	GRN	6
6462	NAELC® 61.0cm Microfiber Fringed Dust Mop	71.1 × 22.9 × 1.3cm	N/A	GRN	6
6463	NAELC® 91.0cm Microfiber Fringed Dust Mop	101.6 × 22.9 × 1.3cm	N/A	GRN	6
6464	NAELC® 122.0cm Microfiber Fringed Dust Mop	132.1 × 22.9 × 1.3cm	N/A	GRN	6
6465	NAELC® 152.0cm Microfiber Fringed Dust Mop	162.6 × 22.9 × 1.3cm	N/A	GRN	6

## NAELC® DRY MOPS

### PRODUCT FEATURES:

1. 100% superfine fiber.
2. With foam-like edges for removing dust and dirt from irregular corners.
3. Large dusting pads (6472/6473/6474) have greater cleaning coverage by 40% than the comparative.



Model	Description	Dimensions	Capacity	Color	Pack
6471	NAELC® 46.0cm Microfiber Room Dust Mop	47.0 × 14.0 × 1.3cm	N/A	GRN, WHT	12
6472	NAELC® 61.0cm Microfiber Hall Dust Mop	62.2 × 14.0 × 1.3cm	N/A	GRN	12
6473	NAELC® 91.0cm Microfiber Hall Dust Mop	92.7 × 14.0 × 1.3cm	N/A	GRN	12
6474	NAELC® 122.0cm Microfiber Hall Dust Mop	123.2 × 14.0 × 1.3cm	N/A	GRN	12

## NAELC® WET MOPS

### PRODUCT FEATURES:

1. 100% superfine fiber.
2. Special handling mop surface (6501) effectively cleans stains from floor surfaces.
3. Compared with a traditional mop, it reduces 95% of the chemical usage.
4. Compared with a traditional wet mop, it saves 90% water.
5. It has a longer service life and higher cleaning efficiency when used together with a bleach and water solution.
6. Without bleach the mops can be repeatedly washed up to 500 times, or up to 200 times when used together with bleach.
7. Washable in water up to 93°C without bleach solution.
8. Various mop colors available to help reduce the risk of cross contamination between work areas.



Innovated blue rigid string to remove stubborn stains effectively

Model	Description	Dimensions	Capacity	Color	Pack
6500	NAELC® 28cm Microfiber Damp Room Mop	34.8 × 14.0 × 1.3cm	N/A	BLUE	6
6501	NAELC® 46cm Microfiber Super Scrubber Mop	50.8 × 14.0 × 1.3cm	N/A	YEL	6
6502	NAELC® 46cm Microfiber Damp Room Mop	53.5 × 15.2 × 1.3cm	N/A	BLUE, GRN, RED	12
6503	NAELC® 61cm Microfiber Damp Room Mop	62.2 × 14.0 × 1.3cm	N/A	BLUE	12

## NAELC® DUST MOP HANDLES AND DUST MOP FRAMES

### PRODUCT FEATURES:

1. Corrosion-resistant, powder-coated dust mop frames allow for durable performance.
2. Spring-loaded clip easily attaches to the dust mop frame.
3. Sliding collar locks the handle into position or allow for a full 360° swivel action.
4. Available in easily sanitized hardwood handle.

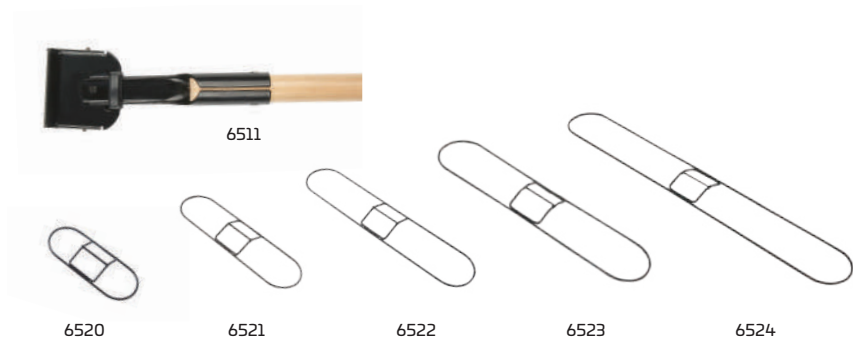

Model	Description	Dimensions	Capacity	Color	Pack
6511	NAELC® Snap-on Wire Dust Mop Handle, Hard Wood	152.4cm	N/A	LAC	12
6513	NAELC® Snap-on Wire Dust Mop Handle	152.4cm	N/A	MSILV	12
6520	NAELC® Dust Mop Frame	30.5 × 12.7cm	N/A	BLA	12
6521	NAELC® Dust Mop Frame	45.7 × 12.7cm	N/A	BLA	12
6522	NAELC® Dust Mop Frame	61.0 × 12.7cm	N/A	BLA	12
6523	NAELC® Dust Mop Frame	91.4 × 12.7cm	N/A	BLA	12
6524	NAELC® Dust Mop Frame	121.9 × 12.7cm	N/A	BLA	12

## NAELC® DUST MOPS

### PRODUCT FEATURES:

1. Premium dust mop for general-purpose dust mopping
2. Pre-treated and pre-shrunk.
3. Fully washable for a longer service life.
4. Envelope-end backing style.
5. All sewn construction.



Model	Description	Dimensions	Capacity	Color	Pack
6530	NAELC® Dust Mop	34.0 × 14.5cm	N/A	BLUE, WHT	12
6531	NAELC® Dust Mop	47.0 × 14.5cm	N/A	BLUE, WHT	12
6532	NAELC® Dust Mop	65.0 × 14.5cm	N/A	BLUE, WHT	12
6533	NAELC® Dust Mop	95.0 × 14.5cm	N/A	BLUE, WHT	12
6534	NAELC® Dust Mop	125.0 × 14.5cm	N/A	BLUE, WHT	12

## WEDGE DUST MOPS

### PRODUCT FEATURES:

1. Suitable for corners, around the bottom of appliances and behind furniture.
2. Galvanized iron wire frame and wooden handle.
3. Envelope-end backing design.



Model	Description	Dimensions	Capacity	Color	Pack
6512	Wedge Mop Handle and Frame	N/A	N/A	LAC	12
6561	Wedge Mop Dust Mop Head, Looped-end	N/A	N/A	YEL	12
6562	Wedge Dust Mop Head, Cut-end	N/A	N/A	YEL	12

# MICROFIBER CLEANING SYSTEM



## MICROFIBER TECHNOLOGY

Microfiber is an extremely thin thread - 10,000 meters of which weighs just 1 gramme! By way of comparison: microfibers are twice as fine as silk fibers (the thinnest natural fiber), 3 times finer than cotton fibers and 200 times finer than a human hair. As a result, they offer a much greater "contact surface" for dirt absorption than the fibers commonly used in mops and cloths.

Due to their fineness, microfibers develop a mechanical cleaning action even in the micropores of surfaces which cannot be registered by the human eye. They easily capture dirt thanks to their hair-like scaly structure.

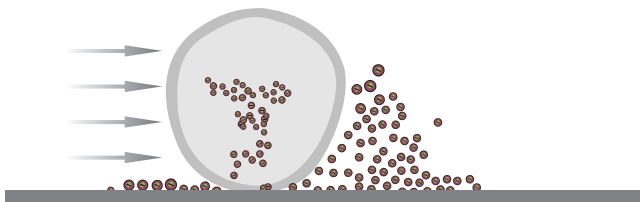

**ORDINARY FIBER**  
leaves dirt behind after cleaning

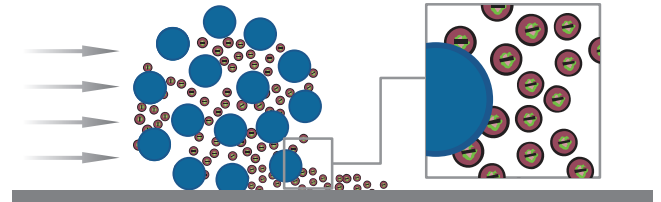

**MICROFIBER**  
wipes away more than 99.99% of bacteria and dirt



## Proven Performance To Ensure Healthy, Safe Environments

- Superior microfiber proven to remove microorganisms
- Helps reduce cross-transmission
- Withstands up to 500 commercial launderings

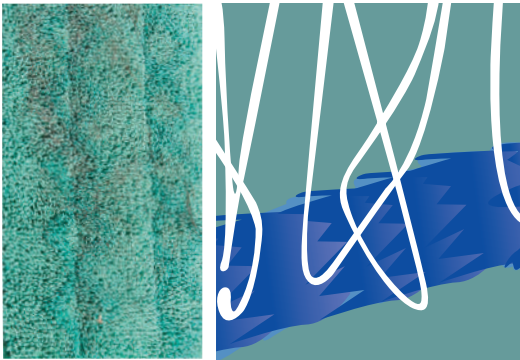

The high-quality microfiber cleans amazingly and leaves floors shinier.

## Sustainable Development Low Cost and High Benefits

**Economic Return:** Use with water only. Save the cost of chemical detergent by 90%. Cut the cost for disposable items and relevant garbage disposal expense.

**Social Welfare:** Improve the health and safety of operators by eliminating the use of chemical detergents.

**Environment Benefit:** Reduce pollution to the environment by reducing the consumption of water and avoiding the use of chemical detergents.

Premium superfine fibers make your floor brighter

Increase the cleanliness of floors by 45% when compared to regular mops.

25% better cleaning effects than traditional microfiber dust pads

Effectively removes over 99.9% of bacteria and dirt with less water (only 1.5L for every 250 m<sup>2</sup>)



## U-RAG® MICROFIBER CLOTHS



### PRODUCT FEATURES:

1. Double finished edges add durability.
2. Durable construction withstands more than 500 launderings.
3. Allows for a sterilization in 100°C hot water without bleaching agent.
4. Color coded products help reduce cross-contamination by differentiating area of use.



Model	Description	Dimensions	Capacity	Color	Pack
6431	U-RAG® Microfiber Bathroom Cloth	40.6 × 40.6cm	N/A	YEL	12
6432	U-RAG® Microfiber General Purpose Cloth	40.6 × 40.6cm	N/A	BLUE, GRN, RED	12
6433	U-RAG® Microfiber Glass/Mirror Cloth	40.6 × 40.6cm	N/A	BLUE	12
6434	U-RAG® Microfiber XL General Purpose Cloth	50.8 × 50.8cm	N/A	GRN	12
6435	U-RAG® Microfiber Bathroom Cloth	30.0 × 30.0cm	N/A	YEL	12
6436	U-RAG® Microfiber General Purpose Cloth	30.0 × 30.0cm	N/A	BLUE, GRN, RED	12
6437	U-RAG® Microfiber Glass/Mirror Cloth	30.0 × 30.0cm	N/A	BLUE	12

## U-RAG® LIGHT MICROFIBER CLEANING CLOTHS



### PRODUCT FEATURES:

1. Microfiber technology optimizes the effect of cleaning.
2. Washable and reusable up to 100 times.
3. Bleach as needed.
4. More effective at cleaning than cotton cloths up to 30%.
5. Effective at capturing up to 99.9% of bacteria.
6. Reduces chemical use more effectively.



Model	Description	Dimensions	Capacity	Color	Pack
6485	U-RAG® Light Microfiber Cleaning Cloth	40.6 × 40.6cm	N/A	RED	144
6486	U-RAG® Light Microfiber Cleaning Cloth	40.6 × 40.6cm	N/A	YEL	144
6487	U-RAG® Light Microfiber Cleaning Cloth	40.6 × 40.6cm	N/A	BLUE	144
6488	U-RAG® Light Microfiber Cleaning Cloth	40.6 × 40.6cm	N/A	GRN	144
6571	U-RAG® Light Microfiber Cleaning Cloth	30.0 × 30.0cm	N/A	RED	144
6572	U-RAG® Light Microfiber Cleaning Cloth	30.0 × 30.0cm	N/A	YEL	144
6573	U-RAG® Light Microfiber Cleaning Cloth	30.0 × 30.0cm	N/A	BLUE	144
6574	U-RAG® Light Microfiber Cleaning Cloth	30.0 × 30.0cm	N/A	GRN	144



## U-RAG® SUPERFINE FIBER CLOTHS

### PRODUCT FEATURES:

1. Superfine fiber cloth offers optimized cleaning performance.
2. Rinsable and reusable, withstands washing up to 40 times.
3. Bleach cleaning safe.
4. 30% higher decontamination capabilities than cotton rag.
5. Removes more than 99.9% of the bacteria and dirt.
6. Reduces the use of chemical cleansers.
7. Extends service life, reduces the use of paper towels.



Model	Description	Dimensions	Capacity	Color	Pack
6481	U-RAG® Superfine Fiber Cloth	48.3 × 40.6cm	N/A	RED	144
6482	U-RAG® Superfine Fiber Cloth	48.3 × 40.6cm	N/A	YEL	144
6483	U-RAG® Superfine Fiber Cloth	48.3 × 40.6cm	N/A	BLUE	144
6484	U-RAG® Superfine Fiber Cloth	48.3 × 40.6cm	N/A	GRN	144

## U-RAG® MICROFIBER MITTS

### PRODUCT FEATURES:

1. Reach into crevices and irregular surfaces for easy cleaning.
2. 6441 fit for general cleaning.
3. 6442 fit for glass or chrome-plated surface cleaning.
4. 6443 fit for dry dusting cleaning.



6441

6442

6443

Model	Description	Dimensions	Capacity	Color	Pack
6441	U-RAG® Microfiber All Purpose Mitt with Thumb	27.9 × 22.2cm	N/A	GRN	12
6442	U-RAG® Microfiber Glass/Mirror Mitt with Thumb	27.9 × 22.2cm	N/A	BLUE	12
6443	U-RAG® Microfiber Dusting Mitt with Thumb	30.2 × 25.1cm	N/A	GRN	6



# MICROFIBER CLEANING SYSTEM

## U-RAG® MICROFIBER DUSTERS

### PRODUCT FEATURES:

1. Reach into crevices and awkward places to remove dust, dirt and allergens.
2. Replacement sleeves are washable.
3. Handles may be bent to any angle for high cleaning efficiency.
4. Quick-connect dusting wand can be changed to a long handle.
5. 6453 is effective in cleaning extreme-dirt areas and removing hairs or large debris.



6451

6453

Model	Description	Dimensions	Capacity	Color	Pack
6451	U-RAG® Quick-connect Flexible Dusting Wand with Microfiber Sleeve	70.5 × 8.3 × 2.9cm	N/A	GRN	6
6452	U-RAG® Wand Duster Microfiber Replacement Sleeve	54.0 × 8.3 × 1.9cm	N/A	GRN	6
6453	U-RAG® Quick-connect Flexible Dusting Wand with High Performance Sleeve	72.1 × 11.0 × 2.9cm	N/A	WHT	6
6454	U-RAG® Wand Duster High Performance Microfiber Replacement Sleeve	57.7 × 11.0 × 2.8cm	N/A	WHT	6

## LAUNDRY NETS

### PRODUCT FEATURES:

1. Helps protect mops and other cleaning items during laundering.



6986

Model	Description	Dimensions	Capacity	Color	Pack
6986	Laundry Net	91.4 × 61.0cm	N/A	WHT	12





# BROOMS AND BRUSHES

## BROOMS AND BRUSHES COMPONENTS

To improve cleaning productivity it is important to select the correct brooms and brushes to suit the floor material and the kinds of dirt. TRUST provides you with a wide range of brush heads and bristles to suit all kinds of floors.

### BLOCK STRUCTURES

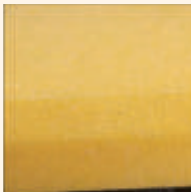

#### PLASTIC FOAM BLOCKS

Lightweight, textured surface, durable, resists splitting, deforming and decaying, non-absorbent, extended service life.



#### WOODEN BODIES

Conventional appearance, resists splitting, vulnerable to decay and mildew.

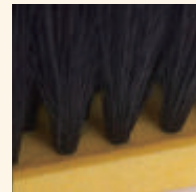

#### INJECTION-MOLDED BLOCKS

Durable, resists splitting, deforming and decaying, non-absorbent, resists bacteria, extended service life.





### BRISTLES - NATURAL MATERIALS



#### HORSEHAIRS

The ends are subject to special treatment to resist breaking and add durability; Resists scratching even on smooth and polished floor; Not fit for applications on oily or warm surfaces.

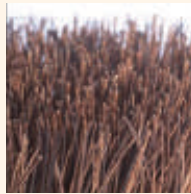

#### PALM LEAVES

Palm leaf fibers of medium to high stiffness are easy to restore to their original form after use; Fit for use on either wet or dry surfaces.

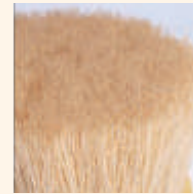

#### TAMPICO FIBERS

Soft and medium stiffness Tampico fibers are easy to restore to their original form after use; Resists heat, alkaline, solvents and acid; Fit for use on either wet or dry surfaces.

### BRISTLES - SYNTHETIC FIBERS

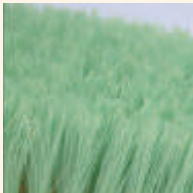

#### NYLONS

Very durable and resistant to wear or breaking; Bristles are easy to restore its original form after operation; Resists stain, fade or odor; Fit for use on either wet or dry surfaces; Resists alkaline and most solvents.



#### POLYVINYL CHLORIDES

Very durable and resistant to wear or breaking; Bristles easily restore to their original form after use, resists stain, water and oil solvents; Not fit for use on residential premises or oily surfaces.

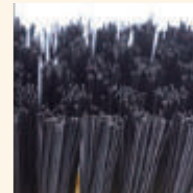

#### POLYPROPYLENES

Very durable and resistant to wear or breaking; It will neither pollute the floor, nor fade or absorb odors. Resists solvents, acid, oil, bacteria. Fit for use on either wet or dry surfaces.

### BRISTLES - METAL WIRES

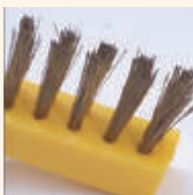

#### COPPER

Resists wearing, won't leave scratches on even hard surfaces; Will not rust; Best for cleaning surfaces of metal or brick surfaces which need to be protected from scratching.

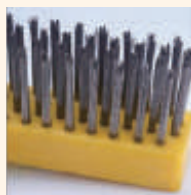

#### STAINLESS STEEL

Resists wearing, water and chemical solutions. Will not rust; Easy to restore its original form after use; Best for tough cleaning jobs such as removal of residues on metals or other persistent dirt.

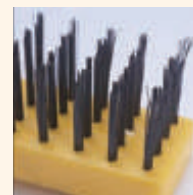

#### STEEL BRISTLES

Resists wearing or corrosion; Easy to restore its original form after operation; Best for tough cleaning jobs such as removal of residues on metal or bricks.

# BROOMS AND BRUSHES

## ANGLE BROOMS

### PRODUCT FEATURES:

1. Ideal for cleaning hard-to-reach areas.
2. Long-lasting stain-resistant Polypropylene bristles.
3. 6623 body comes with 2 handle attachment positions for 2 different cleaning purposes.
4. 6624 cleans medium-sized rubbish, such as fine sand across large cleaning areas.
5. Handle is sold separately.



6623                      6622                      6621                      6613                      6624

Model	Description	Dimensions	Capacity	Color	Pack
6613	Angle Broom, PP Fill	29.0cm	N/A	YEL	12
6621	Angle Broom with Handle, PET Fill	19.0cm	N/A	YEL, BLA	6
6622	Angle Broom, PP Fill	30.0cm	N/A	YEL	12
6623	Angle Broom, PET Fill	32.0cm	N/A	BLA	12
6624	Angle Broom with Handle, PET Fill	48.0cm	N/A	BLA	12

## FINE FLOOR SWEEPS

### PRODUCT FEATURES:

1. Designed to pick up the finest debris.
2. Ideal for highly polished or waxed floors.
3. Two-threaded handle holes on either side of block for even wear.
4. Available in PET or polypropylene, horsehair, Tampico blend.
5. Handle is sold separately.



6632                      6643                      6634

Model	Description	Dimensions	Capacity	Color	Pack
6632	Plastic Foam Block, Fine Floor Sweep, PET Fill	45.5cm	N/A	YEL, BLA	12
6633	Plastic Foam Block, Fine Floor Sweep, PET Fill	61.0cm	N/A	YEL, BLA	12
6634	Hardwood Block, Fine Floor Sweep, PET Fill	92.0cm	N/A	LAC	2
6642	Plastic Foam Block, Fine Floor Sweep, Tampico Fill with Horsehair Border	45.5cm	N/A	YEL, BLA	12
6643	Plastic Foam Block, Fine Floor Sweep, Tampico Fill with Horsehair Border	61.0cm	N/A	YEL, BLA	12
6644	Hardwood Block, Fine Floor Sweep, Tampico Fill with Horsehair Border	92.0cm	N/A	LAC	2



## MEDIUM FLOOR SWEEPS

### PRODUCT FEATURES:

1. Designed to pick up dirt from multiple floor surfaces.
2. Long-lasting polypropylene and natural Tampico bristles are designed to remove heavier dirt and debris on both rough wood and smooth floor surfaces.
3. Two-threaded handle holes on either side of block for even wear.
4. Available in polypropylene, Tampico, or PET+PP blend.
5. Handle is sold separately.



6672

6663

6674

Model	Description	Dimensions	Capacity	Color	Pack
6652	Plastic Foam Block, Medium Floor Sweep, PP Fill	45.5cm	N/A	YEL, BLA	12
6653	Plastic Foam Block, Medium Floor Sweep, PP Fill	61.0cm	N/A	YEL, BLA	12
6654	Hardwood Block, Medium Floor Sweep, PP Fill	92.0cm	N/A	LAC	2
6662	Plastic Foam Block, Medium Floor Sweep, Tampico Fill	45.5cm	N/A	YEL, BLA	12
6663	Plastic Foam Block, Medium Floor Sweep, Tampico Fill	61.0cm	N/A	YEL, BLA	12
6664	Hardwood Block, Medium Floor Sweep, Tampico Fill	92.0cm	N/A	LAC	2
6672	Plastic Foam Block, Medium Floor Sweep, PET and PP Fill	45.5cm	N/A	YEL, BLA	12
6673	Plastic Foam Block, Medium Floor Sweep, PET and PP Fill	61.0cm	N/A	YEL, BLA	12
6674	Hardwood Block, Medium Floor Sweep, PET and PP Fill	92.0cm	N/A	LAC	2

## HEAVY-DUTY FLOOR SWEEPS

### PRODUCT FEATURES:

1. Reliability for industrial-strength jobs.
2. Heavy-duty polypropylene bristles resist stains and odors.
3. Two-threaded handle holes on either side of block for even wear.
4. Handle is sold separately.



6692

6683

6694

Model	Description	Dimensions	Capacity	Color	Pack
6682	Plastic Foam Block, Heavy-duty Floor Sweep, PP Fill	45.5cm	N/A	YEL, BLA	12
6683	Plastic Foam Block, Heavy-duty Floor Sweep, PP Fill	61.0cm	N/A	YEL, BLA	12
6684	Hardwood Block, Heavy-duty Floor Sweep, PP Fill	92.0cm	N/A	LAC	2
6692	Plastic Foam Block, Heavy-duty Floor Sweep, Palmyra Fill	45.5cm	N/A	YEL, BLA	12
6693	Plastic Foam Block, Heavy-duty Floor Sweep, Palmyra Fill	61.0cm	N/A	YEL, BLA	12
6694	Hardwood Block, Heavy-duty Floor Sweep, Palmyra Fill	92.0cm	N/A	LAC	2



## LIGHT WOODEN FLOOR SWEEPS

### PRODUCT FEATURES:

1. Designed to pick up fine debris, such as sands, sawdust, dusts.
2. One tapered hole on either side of block for even wear.
3. Heavy-duty steel handle bracket ensures strength and durability.
4. Polypropylene bristles resist stains and odors.
5. Zigzag nut prevents loosening.
6. Handle is sold separately.



6871

Model	Description	Dimensions	Capacity	Color	Pack
6851	Light Wooden Floor Sweep, PP Fill	30.5 × 6.5cm	N/A	LAC	6
6861	Light Wooden Floor Sweep, PP Fill	40.6 × 9.0cm	N/A	LAC	6
6871	Light Wooden Floor Sweep, PP Fill	45.7 × 6.0cm	N/A	LAC	6
6881	Light Wooden Floor Sweep, PP Fill	60.0 × 6.0cm	N/A	LAC	6
6891	Light Wooden Floor Sweep, PP Fill	60.0 × 7.5cm	N/A	LAC	6

## MEDIUM WOODEN FLOOR SWEEPS

### PRODUCT FEATURES:

1. Designed to pick up medium-sized debris, such as stones, leaves, and metal.
2. One tapered hole on either side of block for even wear.
3. Heavy-duty steel handle bracket ensures strength and durability.
4. Polypropylene bristles resist stains and odors.
5. Zigzag nut prevents loosening.
6. Handle is sold separately.



6852



6882

Model	Description	Dimensions	Capacity	Color	Pack
6852	Medium Wooden Floor Sweep, PP Fill	30.5 × 6.5cm	N/A	LAC	6
6862	Medium Wooden Floor Sweep, PP Fill	40.6 × 9.0cm	N/A	LAC	6
6872	Medium Wooden Floor Sweep, PP Fill	45.7 × 6.0cm	N/A	LAC	6
6882	Medium Wooden Floor Sweep, PP Fill	60.0 × 6.0cm	N/A	LAC	6
6892	Medium Wooden Floor Sweep, PP Fill	60.0 × 7.5cm	N/A	LAC	6

## HEAVY-DUTY WOODEN FLOOR SWEEPS

### PRODUCT FEATURES:

1. Designed to pick up large and heavy debris, such as stones, leaves and straw etc.
2. One tapered hole on either side of block for even wear.
3. Heavy-duty steel handle bracket ensures strength and durability.
4. Polypropylene bristles resist stains and odors.
5. Zigzag nut prevents loosening.
6. Handle is sold separately.



6863



6893



Model	Description	Dimensions	Capacity	Color	Pack
6853	Heavy-duty Wooden Floor Sweep, PP Bristles	30.5 × 6.5cm	N/A	LAC	6
6863	Heavy-duty Wooden Floor Sweep, PP Bristles	40.6 × 9.0cm	N/A	LAC	6
6873	Heavy-duty Wooden Floor Sweep, PP Bristles	45.7 × 6.0cm	N/A	LAC	6
6883	Heavy-duty Wooden Floor Sweep, PP Bristles	60.0 × 6.0cm	N/A	LAC	6
6893	Heavy-duty Wooden Floor Sweep, PP Bristles	60.0 × 7.5cm	N/A	LAC	6



# BROOMS AND BRUSHES

## TOILET BRUSHES

### PRODUCT FEATURES:

1. Available in several handle lengths, head sizes and styles.
2. Polypropylene bristles resist stains and odors.
3. 6798 Toilet Bowl Brushes with TPR non-slip handle offers comfortable handling.



Model	Description	Dimensions	Capacity	Color	Pack
6791	Toilet Brush, Hardwood Handle, PP Fill	43.0cm	N/A	YEL	12
6792	Toilet Brush, Plastic Handle, PP Fill	42.0cm	N/A	WHT	24
6793	Toilet Brush Holder	13.5cm	N/A	WHT	24
6794	Toilet Brush, Plastic Handle, PP Fill	43.0cm	N/A	YEL, BLA	12
6795	Plastic Handle Brush, PP Fill	51.0cm	N/A	YEL	12
6796	Plastic Handle Brush, PP Fill	50.0cm	N/A	YEL	12
6797	Plastic Handle Brush, Tampico Fill	50.0cm	N/A	YEL	12
6798	Toilet Brush, Plastic Handle, PP Fill	42.0cm	N/A	WHT	12

## WIRE BRUSHES

### PRODUCT FEATURES:

1. Special design for various applications.
2. For efficient removal of rust, fouling and grease.
3. Convenient hole at the end of handle for hanging.
4. Metal wire bristles tackle tough cleaning jobs.



Model	Description	Dimensions	Capacity	Color	Pack
6761	Stainless Steel Wire Brush	26.0cm	N/A	YEL, BLA	12
6764	30cm Wire Brush	30.0cm	N/A	YEL, BLA	12
6765	Wire Brush with Scraper	31.0cm	N/A	YEL, BLA	12
6773	28cm Wire Brush	28.0cm	N/A	YEL, BLA	12
6783	Tile and Grout Brush, Brass Bristles	21.6cm	N/A	YEL	12



## COUNTER BRUSHES

### PRODUCT FEATURES:

1. Perfect for quick clean-up of counters.
2. All-plastic structural foam handles ensure strength and durability.
3. Handle with hang-up hole for easy storage.
4. Bristles are available in Polypropylene, Tampico, and PET.



Model	Description	Dimensions	Capacity	Color	Pack
6701	Counter Brush, PET Fill	30.0cm	N/A	YEL, BLA	6
6702	Counter Brush, PP Fill	28.5cm	N/A	YEL, BLA	6
6703	Counter Brush, Tampico Fill	38.5cm	N/A	YEL, BLA	6
6704	Counter Brush, PET Fill	38.5cm	N/A	YEL, BLA	6

## PLASTIC HANDLE UTILITY BRUSHES

### PRODUCT FEATURES:

1. Choice of long or short handles. Available Palmyra, Polypropylene and Tampico bristles.
2. All-plastic structural foam handles ensure strength and durability.
3. Handle with hang-up hole for easy storage.
4. Ideal for food service applications.



Model	Description	Dimensions	Capacity	Color	Pack
6712	Short Plastic Handle Utility Brush, Palmyra Fill	24.0cm	N/A	YEL, BLA	6
6713	Long Plastic Handle Utility Brush, Palmyra Fill	52.0cm	N/A	YEL, BLA	6
6722	Short Plastic Handle Utility Brush, PP Fill	24.0cm	N/A	YEL, BLA	6
6723	Long Plastic Handle Utility Brush, PP Fill	52.0cm	N/A	YEL, BLA	6
6732	Short Plastic Handle Utility Brush, Tampico Fill	24.0cm	N/A	YEL, BLA	6
6733	Long Plastic Handle Utility Brush, Tampico Fill	52.0cm	N/A	YEL, BLA	6



## SCRUB BRUSHES

### PRODUCT FEATURES:

1. Polypropylene and Tampico bristles in plastic block.
2. Designed for easier operation when scrubbing tile, floors, baseboards, walls and counter tops.

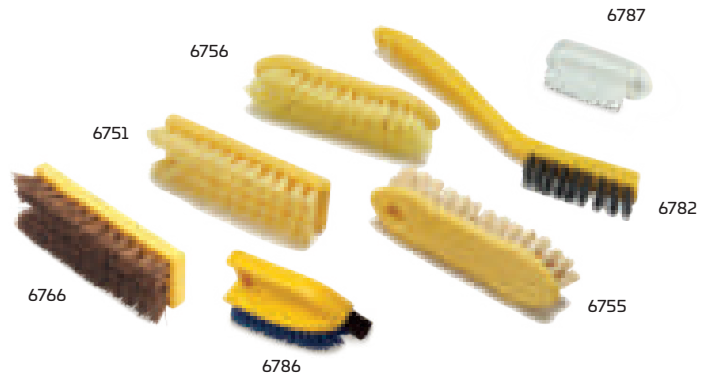

Model	Description	Dimensions	Capacity	Color	Pack
6751	Square Block Scrub Brush, PP Fill	18.5cm	N/A	YEL, BLA	12
6755	Pointed Scrub Brush, Tampico Fill	21.5cm	N/A	YEL, BLA	12
6756	Pointed Scrub Brush, PP Fill	21.5cm	N/A	YEL, BLA	12
6766	Square Block Scrub Brush, Palmyra Fill	18.5cm	N/A	YEL, BLA	12
6782	Tile and Grout Brush, Nylon Fill	22.0cm	N/A	YEL	12
6786	Iron Handle Scrub Brush, PP Fill	17.0cm	N/A	YEL	12
6787	Plastic Hand and Nail Brush, Nylon Fill	10.3cm	N/A	WHT	12

## WASH BRUSHES

### PRODUCT FEATURES:

1. Plastic blocks resist splitting or delaminating to ensure durability and strength.
2. Available in multiple bristle types.
3. Handle is sold separately.



6752 has a **built-in squeegee** which is ideal for cleaning surface liquid



Model	Description	Dimensions	Capacity	Color	Pack
6743	Deck Brush, Tampico and PP Fill	23.0cm	N/A	YEL, BLA	12
6746	Deck Brush, PVC Fill	27.5cm	N/A	YEL, BLA	6
6747	Wash Brush, Nylon Fill	27.5cm	N/A	YEL, BLA	6
6752	Wash Brush with Squeegee, PP Fill	61.0cm	N/A	YEL, BLA	6
6753	Floor Scrub, Plastic Block Tampico Fill	23.0cm	N/A	YEL, BLA	12
6754	Wash Brush, Round Block, PP Fill	26.0cm	N/A	YEL, BLA	6
6784	Deck Brush, Plastic Block, Tampico Fill	Dia 12.0cm	N/A	YEL, BLA	12

## BROOM HANDLES

### PRODUCT FEATURES:

1. Available in threaded or tapered tips.
2. Handles with tapered tips are for use with push brooms.



Model	Description	Dimensions	Capacity	Color	Pack
6350	Steel Broom Handle, with Threaded Tip	2.5 × 72.0cm	N/A	BLA	12
6351	Steel Broom Handle, with Threaded Tip	2.2 × 124.0cm	N/A	BLUE, GRN, RED, YEL	12
6352	Wood Handle, Threaded	2.4 × 137.0cm	N/A	LAC	12
6353	Wood Handle, Threaded	2.4 × 152.0cm	N/A	LAC	12
6362	Wood Handle, Tapered	2.9 × 137.0cm	N/A	LAC	12
6363	Wood Handle, Tapered	2.9 × 152.0cm	N/A	LAC	12
6388	Wood Handle, Threaded Metal Tip	2.4 × 152.0cm	N/A	LAC	12
6389	Steel Broom Handle, with Metal Threaded Tip	2.5 × 150.0cm	N/A	BLA	12



## TOILET BRUSHES

### PRODUCT FEATURES:

1. 6789 has a 15cm diameter head.
2. 30cm length heavy-duty round handle.
3. Funnel-shaped squeezing structure allows moving forward to squeeze without side leakage.
4. Holes on the tailend of handle are available for hanging and storage.
5. Polypropylene texturized filament brush wires offer excellent water absorption and stain removing capabilities; resist acid and alkaline; soft, and non-marking.



Model	Description	Dimensions	Capacity	Color	Pack
6788	Toilet Brush	30.0 × 12.0cm	N/A	WHT	12
6789	Tapered Toilet Brush	30.0 × 12.0cm	N/A	WHT	12
6790	Bathtub Brush	30.0 × 12.0cm	N/A	WHT	12

## TOILET BRUSH HOLDERS

### PRODUCT FEATURES:

1. Provides a secure location for a spray bottle (6947).
2. Toilet bowl brush (6788) can be kept under the fliptop to contain the odors.
3. Compact structure, easy to carry.



6947/6785/6788

Model	Description	Dimensions	Capacity	Color	Pack
6785	Toilet Brush Holder	19.0 × 10.0 × 16.0cm	N/A	BLUE, GRN, RED, YEL, WHT	6



## SCOURING PAD CLEANING SYSTEMS

### PRODUCT FEATURES:

1. Designed to remove stains and dirt on various surfaces.
2. Made of heavy-duty galvanized sheets to add to sturdiness and durability.
3. Ergonomic handles offer a comfortable grip and easy operation.
4. The bracket and pad are easily dismantled. Worn out pads are replaceable.



Model	Description	Dimensions	Capacity	Color	Pack
6601	Steel Scouring Pad Bracket	14.5 × 10.0 × 6.3cm	N/A	BLUE	12
6602	Light Scouring Pad	14.5 × 10.0 × 2.0cm	N/A	WHT	12
6603	Medium Scouring Pad	14.5 × 10.0 × 2.0cm	N/A	BLUE	12
6604	Medium Scouring Pad	14.5 × 10.0 × 2.0cm	N/A	BLA	12

## SCOURING PAD BRUSHES

### PRODUCT FEATURES:

1. 6605 is an ideal tool to clean bathtubs, tiles, sinks, barrels and covers.
2. 6606 is an ideal tool to clean the floor, corner, and trace dirt.
3. 6607 high-performance cleaning particles coupled with premium fiber will effectively remove stains on porcelain floor, stone walls and floor.
4. Plastic scrapper assists in removing persistent and hard stains.



Model	Description	Dimensions	Capacity	Color	Pack
6605	Light Scouring Pad Brush	15.0 × 9.0 × 7.0cm	N/A	WHT	12
6606	Medium Scouring Pad Brush	15.0 × 9.0 × 7.0cm	N/A	BLUE	12
6607	Heavy-duty Scouring Pad Brush	15.0 × 9.0 × 7.0cm	N/A	BLA	12



## CORN BROOMS

### PRODUCT FEATURES:

1. Designed for rugged indoor/outdoor cleaning.
2. 100% natural broom corn fibers for long life and effective pick-up.
3. Removes fine dirt from even or rough surfaces.
4. Hand-selected, heavy-duty lacquered pine handles.



Model	Description	Dimensions	Capacity	Color	Pack
6801	Corn Whisk Broom	31.1cm	N/A	BLUE	12
6802	Lobby Broom, 100% Corn Fill	21.0cm	N/A	RED	12
6803	Corn Broom, Standard, 2.5cm Stained/Lacquered Handle	40.0cm	N/A	RED	12
6804	Corn Broom, Warehouse, 2.9cm Stained/Lacquered Handle	34.0cm	N/A	RED	12
6805	Corn Broom, Warehouse, 2.9cm Stained/Lacquered Handle	30.5cm	N/A	RED	12

## CONDENSER CLEANING BRUSHES

### PRODUCT FEATURES:

1. Designed to clean rear and bottom area of various equipment such as refrigerators and air conditioning condenser.
2. Handle hole for hanging and storage.



Model	Description	Dimensions	Capacity	Color	Pack
6762	Condenser Cleaning Brush	Dia 4.0 × 64.5cm	N/A	YEL	12

## DUSTING BRUSHES

### PRODUCT FEATURES:

1. 6774 is suitable for cleaning the top and bottom of fans.
2. 6775 is suitable for cleaning high steps and platforms.
3. 6994 is suitable for cleaning spider webs from corners.
4. Use with NAELC® quick connect type handle to improve efficiency of cleaning.
5. Handle is sold separately.

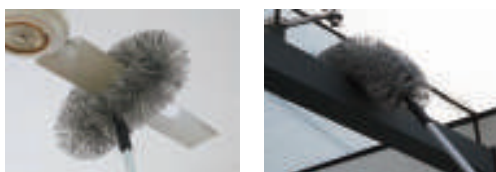

Model	Description	Dimensions	Capacity	Color	Pack
6774	Fan Duster Brush	41.0 × 31.0 × 15.0cm	N/A	BLA	6
6775	Dusting brush	47.0 × 21.0 × 20.0cm	N/A	BLA	6
6994	Spider web dusting brush	Dia: 19.0 × 36.0cm	N/A	BLA	12

## SHOE BRUSHES

### PRODUCT FEATURES:

1. Three-sided cleaning ensures optimized cleaning performance.
2. Heavy-duty steel structure offers strength and durability.
3. Heavy-duty PP brush wires help remove stains and soil easily.



6763

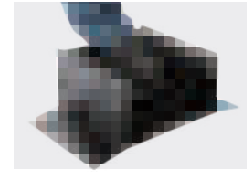

Model	Description	Dimensions	Capacity	Color	Pack
6763	Three-sided Shoe Brush	50.0 × 30.0 × 19.5cm	N/A	BLA	1

## PIPE BRUSHES

### PRODUCT FEATURES:

1. Designed to clean the surface of pipes.
2. A threaded hole is available on the tail to add a handle.
3. Handle is sold separately.



5711



Model	Description	Dimensions	Capacity	Color	Pack
5711	Hook-shaped Brush for Pipeline	29.2cm	N/A	BLUE, GRN, RED, YEL, WHT	12
5712	Circular Brush for Pipeline	30.5cm	N/A	BLUE, GRN, RED, YEL, WHT	12

## CLEANING BRUSHES FOR PIPES

### PRODUCT FEATURES:

1. Designed to clean pipes of various sizes.
2. Material in compliance with FDA requirements.
3. Hole on the tailend of handle for hanging and storage.
4. Select a suitable brush according to the pipe diameter and length.



5663

5641

5633

5621

Model	Description	DIA	Dimensions	Color	Pack
5621	Cleaning Brush for Pipeline	1.0cm	30.5cm	WHT	12
5633	Cleaning Brush for Pipeline	1.3cm	61.0cm	WHT	12
5641	Cleaning Brush for Pipeline	1.6cm	45.7cm	WHT	12
5652	Cleaning Brush for Pipeline	1.9cm	61.0cm	WHT	12
5663	Cleaning Brush for Pipeline	2.5cm	61.0cm	WHT	12
5672	Cleaning Brush for Pipeline	3.8cm	91.4cm	WHT	12
5683	Cleaning Brush for Pipeline	5.1cm	61.0cm	WHT	12

# DUST PANS



## PREDATOR® UPRIGHT DUST PANS

### PRODUCT FEATURES:

1. Stylish appearance and an innovative design.
2. Fit for applications such as a mall, canteen or lobby.
3. Durable rear wheels improve wear resistance and extend product life.
4. Patent pending self-opening and closing lid conceals unsightly dirt and debris.
5. Bracket for storage of Lobby Broom (6621) is available on the handle.



Using the 6915 Upright Dust Pan Hanger Bracket



6911

6912

6913

Model	Description	Dimensions	Capacity	Color	Pack
6911	PREDATOR® Upright Dust Pan with Hook	32.3 × 13.9 × 95.8cm	N/A	BLA	6
6912	PREDATOR® Upright Dust Pan with Cover and Hook	33.2 × 14.4 × 95.8cm	N/A	BLA	6
6913	PREDATOR® Upright Dust Pan with Cover without Hook	33.2 × 14.4 × 95.8cm	N/A	BLA	6
6914	PREDATOR® Upright Dust Pan without Cover and Hook	32.2 × 13.9 × 95.8cm	N/A	BLA	6
6915	PREDATOR® Upright Dust Pan Hanger Bracket	10.6 × 4.9 × 3.7cm	N/A	BLA	6

## PREDATOR® DRY/WET DUST PANS

### PRODUCT FEATURES:

1. Allows dry/wet spills to be swept away quickly and safely.
2. 6916 holds up to 2L liquid or solid debris for efficient clean up.
3. Easy to clean smooth surface.
4. Soft double-layer microporous foam rubber blade cleans well even on uneven surfaces.



6916

6917

Model	Description	Dimensions	Capacity	Color	Pack
6916	PREDATOR® Dry/Wet Dust Pan	44.3 × 27.2 × 111.6cm	2L	BLA	4
6917	PREDATOR® Dry/Wet Floor Squeegee	34.3 × 4.8 × 127.0cm	N/A	BLA	4

## DUST PANS

### PRODUCT FEATURES:

1. Picks up dirt and debris quickly.
2. Durable plastic structure prolongs service life.
3. Available in Extra Large & Jumbo sizes to hold more dirt and debris.
4. 6927, 6928 integrated steel heavy-duty dust pans, suitable for cleaning metal scrap and other hard objects.



Model	Description	Dimensions	Capacity	Color	Pack
6923	Heavy-duty Dust Pan	31.1 × 21.0 × 6.7cm	N/A	BLA	12
6924	Extra Large Dust Pan	40.6 × 37.5 × 13.7cm	N/A	BLA	6
6925	Jumbo Dust Pan	55.9 × 45.7 × 19.7cm	N/A	BLA	6
6926	Heavy-duty Dust Pan and Counter Brush	31.1 × 21.0 × 6.7cm	N/A	BLA	6
6927	Steel Heavy-duty Dust Pan	30.5 × 34.5 × 7.5cm	N/A	BLA	6
6928	Steel Heavy-duty Dust Pan	40.0 × 36.5 × 12.5cm	N/A	BLA	6

## STEP&SWEEP DUST PANS

### PRODUCT FEATURES:

1. Wide mouth dust pan ideal for indoor and outdoor clean-ups.
2. Step-on design helps to hold the dust pan on the ground without bending.
3. Soft rubber leading edge for efficient surface contact.
4. Ergonomic, soft rubber handle, comfortable and convenient.
5. Hole on the tail-end of handle for hanging and storage.



6929



Step-on design helps fixing the dust pans to the ground without bending

Model	Description	Dimensions	Capacity	Color	Pack
6929	Step&Sweep Dust Pan	37.0 × 33.0 × 12.5cm	N/A	GRAY	6

# FLOOR SQUEEGEES



## TRADITIONAL FLOOR SQUEEGEES

### PRODUCT FEATURES:

1. Galvanized metal frame and locking strip.
2. Fits 6362, 6363 wood broom handles which are sold separately.
3. For removing liquids and heavy dirt.



Model	Description	Dimensions	Capacity	Color	Pack
6814	46.0cm Straight Floor Squeegee	45.7 × 10.2 × 17.3cm	N/A	BLA	6
6815	61.0cm Straight Floor Squeegee	61.0 × 10.2 × 17.3cm	N/A	BLA	6
6816	91.0cm Straight Floor Squeegee	91.4 × 10.2 × 17.3cm	N/A	BLA	6
6817	46.0cm Replacement Blade	45.7 × 0.6 × 5.1cm	N/A	BLA	6
6818	61.0cm Replacement Blade	61.0 × 0.6 × 5.1cm	N/A	BLA	6
6819	91.0cm Replacement Blade	91.4 × 0.6 × 5.1cm	N/A	BLA	6
6825	61.0cm Curved Floor Squeegee	59.7 × 10.2 × 17.3cm	N/A	BLA	6

## DUAL MOSS SQUEEGEES

### PRODUCT FEATURES:

1. Non-marking, flexible blades are ideal for uneven surfaces.
2. Leaves floors virtually dry to the touch, ideal for spills.
3. Handles are sold separately.



Model	Description	Dimensions	Capacity	Color	Pack
6841	46.0cm Standard Floor Squeegee	45.7 × 7.6 × 11.4cm	N/A	BLA	10
6842	56.0cm Standard Floor Squeegee	55.9 × 7.6 × 11.4cm	N/A	BLA	10
6843	56.0cm Heavy-duty Floor Squeegee	55.9 × 8.3 × 14.0cm	N/A	BLA	10
6844	76.0cm Heavy-duty Floor Squeegee	76.2 × 8.3 × 14.0cm	N/A	BLA	10

## PROFESSIONAL PLASTIC SQUEEGEES



### PRODUCT FEATURES:

1. Pre-treated polypropylene resists corrosion.
2. Twin black porous foam blades.
3. For removing liquids, moderate dirt.
4. Rubber resists oils, greases and most chemicals.
5. Fits 6351 broom handle which is sold separately.



6831

Model	Description	Dimensions	Capacity	Color	Pack
6831	46.0cm Plastic Professional Squeegee with Black Dual Moss Rubber	45.7 x 5.8 x 8.9cm	N/A	BLUE, GRN, RED, YEL	10



# DUSTING TOOLS



## LAMBSWOOL DUSTERS

### PRODUCT FEATURES:

1. 100% lambs wool duster.
2. Ideal for dusting large areas quickly and effectively.



6987

Model	Description	Dimensions	Capacity	Color	Pack
6987	76.0-100.0cm Lambswool Duster with Telescoping Plastic Handle	N/A	N/A	GRAY	6

## OSTRICH DUSTERS

### PRODUCT FEATURES:

1. Ideal for offices, malls, schools etc.
2. South African ostrich feathers are delicate, pliable, anti-static and with good dusting capability.
3. Handle with hang-up hole for easy storage.



6995

Model	Description	Dimensions	Capacity	Color	Pack
6995	35cm Ostrich Duster	N/A	N/A	LAC	12

## OVERHEAD DUSTING TOOL WITH FLEXIBLE HEAD

### PRODUCT FEATURES:

1. For difficult overhead dusting.
2. Flexible head adjusts to match virtually any shape.
3. The washable dust mitt can be worn on the hand or used with the flexible head dusting tool.
4. Dusting Tool and Dust Mitt are available.



6988

Model	Description	Dimensions	Capacity	Color	Pack
6988	Overhead Dusting Tool with Flexible Head, Flexible Head with 152.0cm Aluminum Handle	N/A	N/A	MSILV	6
6989	Dust Mitt Off-floor Tool, Cotton	N/A	N/A	WHT	12

## OVERHEAD DUSTING TOOLS

### PRODUCT FEATURES:

1. For difficult overhead dusting.
2. Flexible head adjusts to match virtually any shape.
3. The washable dust mitt can be worn on the hand or used with the flexible head dusting tool.
4. Dusting Tool and Dust Mitt are available.



Model	Description	Dimensions	Capacity	Color	Pack
6990	Overhead Dusting Tool with Washable Head, 130.0cm Extension Handle	N/A	N/A	GRAY	12
6991	Overhead Dusting Tool with Angled Washable Head, 130.0cm Extension Handle	N/A	N/A	GRAY	12
6992	Overhead Dusting Tool with Washable Head, 260.0cm Extension Handle	N/A	N/A	GRAY	12
6993	Overhead Dusting Tool Replacement Head, Fits 6990/6991/6992	N/A	N/A	WHT	12

## WALL WASHER KITS

### PRODUCT FEATURES:

1. Pivoting head for smooth, even control.
2. Washable brushes can be changed easily.
3. Quick-Connector for replacing easily and quickly.
4. Handles (6411/6412/6413/6414) need to be purchased separately.



6901/6411

Model	Description	Dimensions	Capacity	Color	Pack
6901	Wall Washer Kit Includes 2 Brushes	20.0 x 9.5 x 17.0cm	N/A	BLA	2
6902	Wall Washer Kit Includes 2 Microfiber Brushes	20.0 x 9.5 x 17.0cm	N/A	BLA	2
6903	Wall Washer Kit Replacement Brushes	23.0 x 12.7cm	N/A	WHT	12
6904	Wall Washer Kit Replacement Microfiber Brushes	23.0 x 12.7cm	N/A	WHT	12





## CLEANING TOOL HOLDERS



### PRODUCT FEATURES:

1. Helps increase productivity and efficiency through better tool storage and access.
2. S-hooks hold 1.6cm to 3.2cm handle diameters.
3. Special hooks afford easy accessibility.
4. Clip for holding a record book.
5. 25113, 25114 and 25115 aluminum alloy material, light and rust-proof. Used with stuck clips, hooks and signboards.
6. 25116 is suitable for holding handles with a diameter of 22-32mm.
7. 25117 is suitable for holding handles with a diameter of 28-38mm.
8. 25118 is suitable for holding cleaning tools with hanging holes.
9. 25119 can be used with the base of the aluminum alloy tool rack, which enables clear identification of the hung tools at each position.



6942



6941



25114/25117/25116/25118/25119



Model	Description	Dimensions	Capacity	Color	Pack
6941	Closet Organizer/Tool Holder Kit	45.7 × 8.3 × 10.8cm	N/A	BLUE, GRN, RED, YEL	6
6942	Closet Organizer/Tool Holder Kit	86.4 × 8.3 × 10.8cm	N/A	BLUE, GRN, RED, YEL	4
25113	HEDGEHOG® Cleaning Tool Rack Base, 300mm	30.0 × 5.0 × 1.0cm	N/A	BLUE, VGRN, RED, GLD	12
25114	HEDGEHOG® Cleaning Tool Rack Base, 500mm	50.0 × 5.0 × 1.0cm	N/A	BLUE, VGRN, RED, GLD	12
25115	HEDGEHOG® Cleaning Tool Rack Base, 900mm	90.0 × 5.0 × 1.0cm	N/A	BLUE, VGRN, RED, GLD	12
25116	HEDGEHOG® Small Stuck Clip	8.0 × 8.0 × 3.6cm	N/A	BLUE, VGRN, RED, GLD	12
25117	HEDGEHOG® Large Stuck Clip	8.5 × 8.0 × 3.6cm	N/A	BLUE, VGRN, RED, GLD	12
25118	HEDGEHOG® Hook	4.0 × 4.4 × 3.3cm	N/A	BLUE, VGRN, RED, GLD	12
25119	HEDGEHOG® Signboard	11.2 × 12.5 × 0.9cm	N/A	BLUE, VGRN, RED, GLD	12

## IRONING ORGANIZERS

### PRODUCT FEATURES:

1. An ideal solution for placing a hot iron.
2. Installs easily, virtually anywhere.
3. Efficiently stores iron with ironing board for convenience.
4. Ultimate heat resistant plastic construction.
5. Aesthetic design complements guest room decor.



6951

Model	Description	Dimensions	Capacity	Color	Pack
6951	Ironing Organizer	13.3 × 29.4cm	N/A	BLA, WHT	6

## COMMERCIAL CLEANING AND MAINTENANCE GLOVES

### PRODUCT FEATURES:

1. Designed for harsh applications and rough materials.
2. Non-skid Neoprene is available at the finger tip to ensure a non-slip grip.
3. Breathable stretch materials add to comfort.
4. Designed with elastic materials at the palm to reduce shock.



6983



Designed with **elastic materials at the palm** to reduce shock

Model	Description	Dimensions	Capacity	Color	Pack
6983	Heavy-duty Glove, Large	24.5 × 11.4cm	N/A	BLA	6
6984	Heavy-duty Glove, Extra Large	24.5 × 11.8cm	N/A	BLA	6

## PROFESSIONAL KNEEPADS

### PRODUCT FEATURES:

1. Non-marking cap protects surfaces.
2. Non-skid cap helps to avoid slipping.
3. Breathable perforated Neoprene materials.
4. Notched for comfort when standing.
5. One-strap sizing plus opening for ventilation.



6985



**Professional kneepad** can protect your knees from harm

Model	Description	Dimensions	Capacity	Color	Pack
6985	Professional Kneepads	22.9 × 17.8 × 10.8cm	N/A	BLA	6

## FOLDING STEPSTOOLS

### PRODUCT FEATURES:

1. Slip resistant surfaces on steps and foot pads.
2. Easy to transport and space efficient with folded size only 15.9cm.
3. Plastic web-structure molded, supports loads up to 150 kg.
4. Easy to clean and resistant to other damage.
5. Meeting the standards of EN 14183:2003.



6932



Easy to transport

Model	Description	Dimensions	Load	Color	Pack
6932	Two-step Folding Stepstool	Open: 47.5 × 51.5 × 59.0cm Closed: 47.5 × 15.9 × 65.0cm	150 kg	GRAY, DGRAY, BLA	3

## MOVABLE STEPSTOOLS

### PRODUCT FEATURES:

1. Compression castors for easy mobility.
2. Supports loads up to 160 kg.
3. The two steps are equipped with a soft non-slip pad.
4. The castors will automatically retract when weight is applied.
5. Heavy-duty plastic structure, solid and durable, and will not damage walls or furniture.
6. Meets standards EN14183:2003.



6933

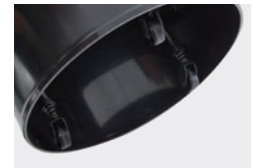

Compression castors  
for easy mobility

Model	Description	Dimensions	Load	Color	Pack
6933	Movable Two-step Stepstool	40.6 × 34.3cm	160 kg	BLA, BEIG	1

## ROTMOLDED PLASTIC PEDALS

### PRODUCT FEATURES:

1. Rotomolded; industrial-grade; sturdy and durable.
2. One-piece body construction provides superior strength and durability.
3. The two pedals are equipped with a soft non-slip pad.
4. Bearing up to 160 kg.
5. Rubber pad at the bottom with anti-skid function, increase security.
6. Four direction pedal design, easy to use.
7. Meeting the standards of EN 14183:2003.



6930

Model	Description	Dimensions	Load	Color	Pack
6930	Rotomolded Plastic Pedal	49.0 × 49.0 × 36.4cm	160 kg	YEL, BLA	1

# MULTI-FUNCTION LADDERS

## PRODUCT FEATURES:

1. Complies with the requirements of ANSI 14.2, AS/NZS 1892.1 and EN-131.
2. Patented auto-locking hinge design.
3. Triple modes of A-shaped ladder, straight ladder and extension ladder.
4. Made from premium quality lightweight aluminum, with outstanding strength and durability.
5. Non-slip step design for added safety.
6. Reliable soft tips feet.
7. Can be folded down to save space and transportation costs.
8. Extends up to four times folded height.



### 6945 Schematic Work Status

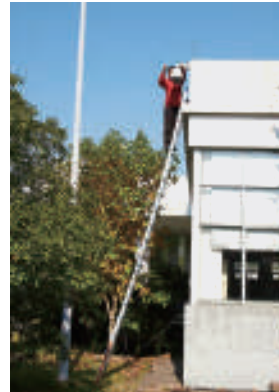
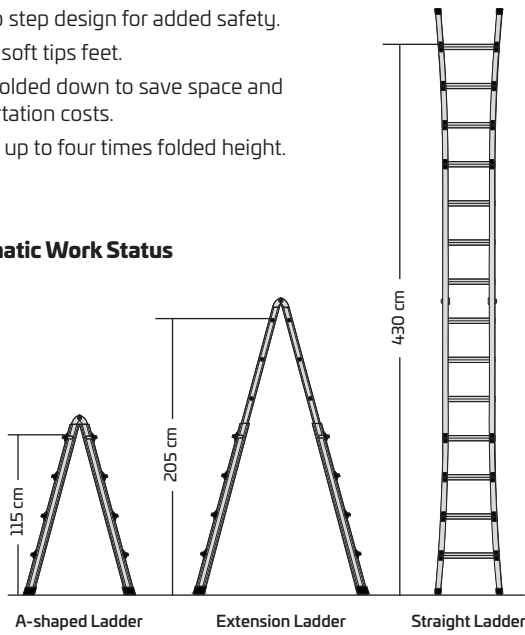

Can be quickly converted into a **straight ladder**, high operating convenience



Can be **used on the stairs**, safe and reliable

Model	Description	Dimensions	Extension Length	Folding Length	Load	Color	Pack
6945	Multi-function Ladder	131.0 × 60.5 × 20.0cm	452.0cm	220.0cm	150 kg	MSILV	1
6946	Multi-function Ladder	198.0 × 75.0 × 20.0cm	686.0cm	334.0cm	150 kg	MSILV	1



## FOLDING LADDERS

### PRODUCT FEATURES:

1. Made by premium quality lightweight aluminum, with outstanding strength and durability.
2. Can be folded down easily and quickly, compactable for space saving.
3. Non-slip step design for safety.
4. Reliable soft tips feet.



Model	Description	Dimensions	Load	Color	Pack
6943	Two-step Folding Ladder	Open: 46.0 × 47.0 × 92.0cm Closed: 46.0 × 15.2 × 98.5cm	120 kg	BLA	1
6944	Three-step Folding Ladder	Open: 51.0 × 63.5 × 116.0cm Closed: 51.0 × 15.2 × 123.5cm	120 kg	BLA	1

## DELUXE CARRY CADDIES

### PRODUCT FEATURES:

1. Perfect for carrying tools and cleaning supplies.
2. Conveniently fits on cleaning and housekeeping carts.
3. User friendly handles fit your hand and allow for a comfortable grip.
4. Securely holds spray bottle (6935) and other common cleaning tools.
5. Allows for stable stacking to save space.
6. Rounded corners ensure safety and prevent injury.
7. Innovative design, double-layer toolbox (6955) can carry more cleaning supplies at once to improve work efficiency.
8. 6955 used with 6956 to locate toilet brush.



6955 used with 6956 to locate toilet brush

Model	Description	Dimensions	Capacity	Color	Pack
6931	Deluxe Carry Caddy	38.6 × 28.0 × 17.0cm	N/A	BLA	6
6955	Double-layer Tool Basket	38.4 × 26.5 × 28.8cm	N/A	BLA	3
6956	Toilet Brush Holder for 6955	10.3 × 9.0 × 9.1cm	N/A	BLA	6

## NOZZLE AND SPRAY BOTTLES



### PRODUCT FEATURES:

1. Easier and more efficient for a variety of cleaning jobs.
2. Adjustable nozzle, spray distance up to 75cm.
3. High-capacity up to 3ml.
4. Sturdy HDPE spray bottle won't be damaged even in case of collision or falling thanks to its excellent strength and toughness.
5. Ergonomic grip-type nozzle offers a comfortable hold and easy operation.



Model	Description	Dimensions	Capacity	Color	Pack
6934	Nozzle	12.5 × 3.3 × 34.0cm	N/A	BLUE, GRN, RED, YEL, WHT	12
6935	950ml Spray Bottle	8.9 × 25.0cm	N/A	WHT	12
6947	Spray Bottle with Trigger	12.5 × 8.5 × 34.0cm	N/A	RED	12
6952	650ml Spray Bottle	8.9 × 20.0cm	N/A	WHT	12

## PNEUMATIC SPRAYERS

### PRODUCT FEATURES:

1. Easier and more efficient for a variety of cleaning jobs.
2. Sturdy and durable structure.
3. Adjustable nozzle for spraying mist or water droplets.



Model	Description	Dimensions	Capacity	Color	Pack
6936	Pneumatic Sprayer	N/A	1.0L	WHT	12
6937	Pneumatic Sprayer	N/A	1.5L	WHT	12
6938	Pneumatic Sprayer	N/A	2.0L	WHT	12



## NIPPERS

### PRODUCT FEATURES:

1. Safely collects syringes, sharp objects and general waste.
2. User-friendly handle provides comfortable and easy maneuverability.
3. Clamp made of soft materials to enable an easy pick-up of objects.



6997

Model	Description	Dimensions	Capacity	Color	Pack
6996	Nipper	45.0cm	N/A	BLA	12
6997	Nipper	84.0cm	N/A	BLA	12

## TOILET PUMPS

### PRODUCT FEATURES:

1. Head made of rubber suitable for unblocking toilets and sewers.
2. Produces high pressure for unblocking.
3. Handle hole for hanging and storage.



6939



6940

Model	Description	Dimensions	Capacity	Color	Pack
6939	Toilet Pump	14.0 × 50.5cm	N/A	BLA	12
6940	Toilet Pump	14.5 × 51.5cm	N/A	BLA	12

## SCRAPERS

### PRODUCT FEATURES:

1. Heat treated carbon steel blade for maximum strength.
2. Polished blade treated with a clear coat protectant against corrosion.
3. Contoured handle helps reduce effort.
4. Non-slip elastic handle offers a comfortable hold.



6981



6982

Model	Description	Dimensions	Capacity	Color	Pack
6981	8.0cm Scraper	21.3 × 7.6 × 2.4cm	N/A	BLA	6
6982	4.0cm Scraper	20.3 × 4.0 × 2.4cm	N/A	BLA	6





## HEIMDALL® BABY CHANGING STATIONS



### PRODUCT FEATURES:

1. Wide table is equipped with adjustable seat belts enhancing safety and reliability.
2. All plastic web structure ensures strength and durability.
3. Two die cast hooks are convenient for hanging accessories.
4. Storage units at the top of the table are convenient to place baby care products.
5. Closed width is only 10.2cm, saving space.
6. Table is equipped with handle, convenient to open.
7. Built-in shelf and liner storage.
8. Microban® antibacterial technology effectively inhibits bacterial growth and odor generation.
9. Meeting the standards of ASTM F2285 and EN 12221-1.



8021



8023



### MICROBAN® ANTI-BACTERIA PROTECTION TECHNOLOGIES

1. Microban® anti-bacteria technologies provide full protection and resist odor and stain due to bacteria.
2. Microban® anti-bacteria ingredients have been added to the baby changing station during its production for permanent protection.



Plastic sample without Microban® anti-bacteria ingredients.



Plastic sample with Microban® anti-bacteria ingredients.

\*Microban® is the registered owner of Microban® trademark, and reserves all the rights. Microban® anti-microbial protection is not designed to protect users against disease causing micro-organisms and is not a substitute for routine cleaning.



Two die cast hooks are convenient for hanging accessories. Storage units at the top of the table are convenient for placing baby care products.

Model	Description	Dimensions	Color	Pack
8021	HEIMDALL® Baby Changing Station	Closed: 84.5 × 54.6 × 10.2cm	LPLAT	1
8022	Protective Liners For Baby Changing Station (20 Units)	32.5 × 44.5cm	WHT	16
8023	HEIMDALL® Baby Changing Station	Closed: 58.4 × 86.6 × 10.2cm	LPLAT	1

## KID&COOL® INFANT SAFETY SEATS

### PRODUCT FEATURES:

1. All plastic web structure ensures strength and durability.
2. Strap type safety belt for effective protection.
3. Closed width is only 13.0cm, saving space.
4. Smooth surface for easy cleaning.
5. Microban® antibacterial technology effectively inhibits bacterial growth and odor generation.
6. Meeting the standards of ASTM F2613 and EN 12520.



8031

Model	Description	Dimensions	Color	Pack
8031	KID&COOL® Infant Safety Seat	Closed: 35.5 × 13.0 × 48.6cm	LPLAT	1



## WALL-MOUNTED SANITARY NAPKIN RECEPTACLES

### PRODUCT FEATURES:

1. Saves space, easy to use.
2. Tightly-sealed cover prevents odors spreading.
3. Detachable stiff liner is easy to clean and maintain.
4. Smooth surface for easy cleaning.
5. Five waxed bags are included for easy collection of waste and to maintain clean inner walls.



6950

Model	Description	Dimensions	Capacity	Color	Pack
6950	Wall-mounted Sanitary Napkin Receptacle	27.3 x 13.3 x 31.8cm	N/A	WHT	1
6998	Waxed Bag (50 per bundle)	22.2 x 21.6cm	N/A	N/A	5

## FEMININE SANITARY BINS

### PRODUCT FEATURES:

1. The safe, sanitary solution for handling personal waste.
2. Smooth surfaces are easy to clean and avoid hidden dirt and bacteria.
3. Pedal operation avoids direct contact.
4. Deep grooves prevent sanitary napkins from adhering to bin walls.
5. Lined interior for stain prevention.



6949

6948



Model	Description	Dimensions	Capacity	Color	Pack
6948	Pedal Sanitary Bin	42.3 x 15.5 x 49.0cm	11L	GRAY, WHT	1
6949	Pedal Sanitary Bin	48.2 x 15.5 x 53.9cm	19L	GRAY, WHT	4
6966	Bin Liner Refills (15 Pieces Per Roll), for 6948	N/A	N/A	N/A	12
6967	Bin Liner Refills (15 Pieces Per Roll), for 6949	N/A	N/A	N/A	12

## BATH MATS

### PRODUCT FEATURES:

1. Does not contain natural rubber latex, which may cause allergic reactions.
2. Perfect for shower stall or bathtub.
3. Suction-backed to stay firmly in place.
4. Textured surface prevents slippage.
5. Products containing antibacterial agents, inhibiting the growth of bacteria, mildew resistant.



6961

6963

Model	Description	Dimensions	Capacity	Color	Pack
6961	Bath Mat	57.2 x 35.6cm	N/A	BEIG, WHT	4
6963	Bath Mat	71.1 x 40.6cm	N/A	BEIG, WHT	4
6965	Bath Mat	91.4 x 45.7cm	N/A	BEIG, WHT	4





**MOBILE WORK CENTERS**

Bitbar® Mobile Work Centers	146
Bitbar® Utility Carts	147
Bitbar® Flat-shelf Carts	147
Ladder Carts	148
Material Supply Carts	149

**PLATFORM TRUCKS**

Castors Selection Guide	150
Oeasy® Platform Trucks	152
Oeasy® A-Frame Panel Trucks	153
Oeasy® Sheet & Panel Trucks	153
Oeasy® Work Height Platform Trucks	154
Oeasy® Stanchion Platform Trucks	155
Oeasy® Skid Platform Trucks	155
Oeasy® Panel Platform Trucks	156
Utility Trolleys	156
Totes Trolleys	157

**CUBE TRUCKS**

Cube Trucks	158
-------------	-----

**TILT TRUCKS**

Rotomolded Tilt Trucks	160
Heavy-duty Towable Tilt Trucks	160
Heavy-duty Forkliftable Tilt Trucks	161
Structural Foam Tilt Trucks	161
Tilt Truck Covers	162
Collapsible Linen Carts	162

**UTILITY SERVICE CARTS**

Hi5® Utility Service Carts	164
Hi5® Folding Service Carts	166

**CART ACCESSORIES**

Cart Accessories Selection Guide	168
----------------------------------	-----

**STORAGE AND ORGANIZATION**

Shelving Systems	170
Bitbar® Tool Boxes	171
Thor® Large Totes with Lid	171
Thor® Stackable Tote Bins	172
Multi-function Ladders	173
Folding Ladders	173
Folding Stepstools	174
Movable Pedals	174
Rotomolded Plastic Pedals	174
Storage Pallets	175
Goods Shelves	175

**CONTAINER TOOLS**

Nestable Pallets	176
Shelf Pallets	177
Stacking Pallets	177
Heavy-load Bulk Containers	178

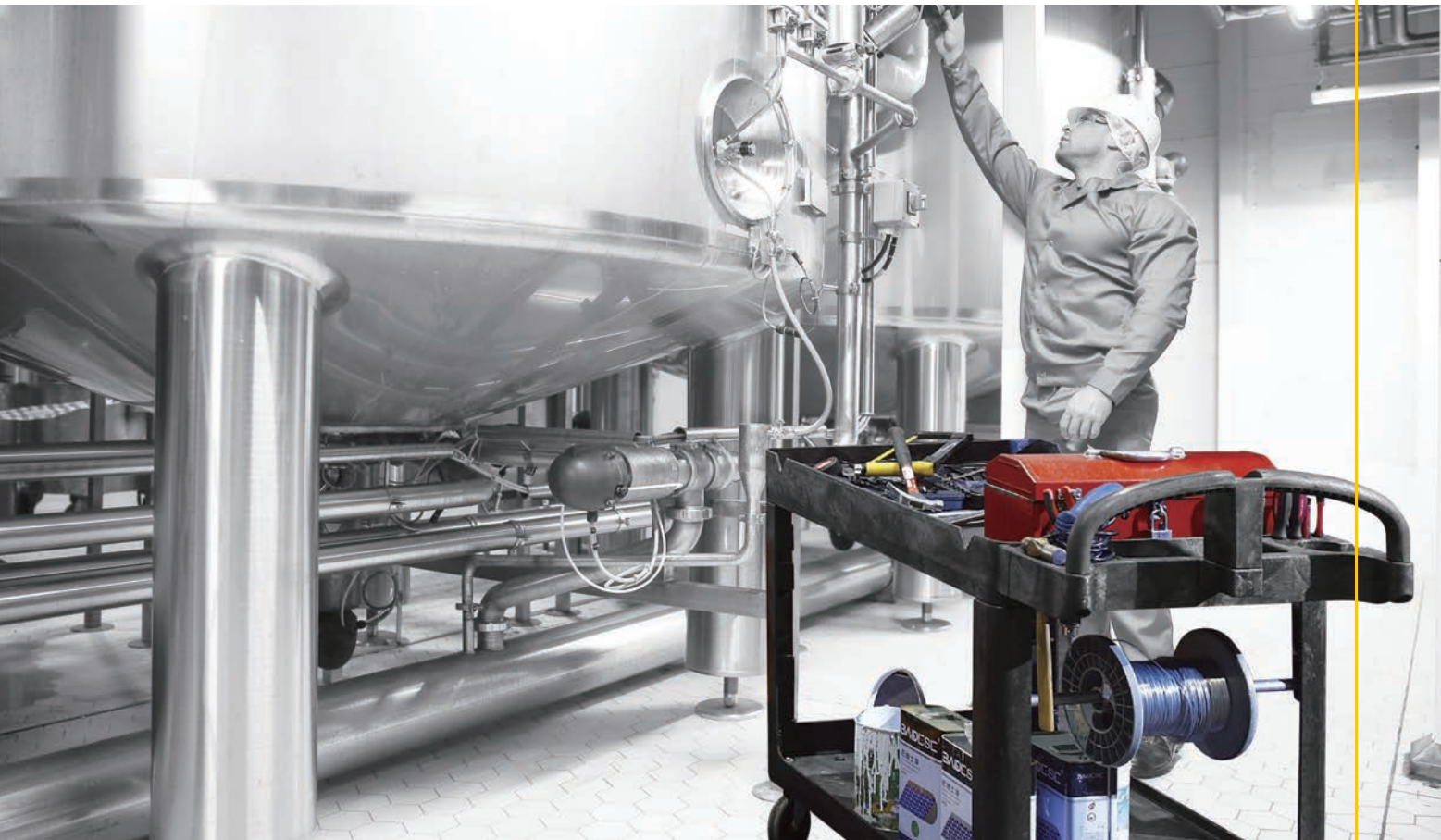

## Innovative Designs

TRUST platform trucks and utility carts deliver transport solutions to meet the demands of every environment.

## Robust construction resists distortion, dents, breakage, rust and decay

Tough, resilient surface absorbs impact and provides quiet operation. Virtually maintenance-free; resistant to most chemicals, impervious to water damage, and can be easily cleaned.



Conventional metal trolleys are susceptible to dents and rust.



Conventional wooden trolleys are susceptible to splinters and rot

## Transport Materials Effectively and Safely

The handle on the cart is adjustable to fit your height and reduce muscle strain.

## Castors meet exacting demands

Castors are optimized for each product through repeated testing to provide the most effective and durable material transport solutions.



Polyolefin

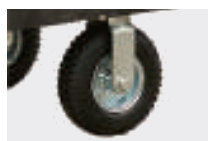

Pneumatic



Thermoplastic Rubber

# MOBILE WORK CENTERS



## BITBAR® MOBILE WORK CENTERS



### PRODUCT FEATURES:

1. Innovative design for easy transportation of any item.
2. Sturdy structural foam construction won't rust, dent, chip, or peel.
3. Molded-in storage compartments and cup holder are suitable for storage of small items and tools.
4. User friendly handles provide comfortable and easy maneuverability.
5. 12.5cm non-marking castors (two fixed and two swivel with full braking mechanism) ensure easy maneuverability.
6. Full extension metal drawers with ball bearing slides are available.



4031

4033



The top has open-side to enable convenient use



The grooves on the top prevent small items against rolling out



Lockable storage compartment helps keep contents secure



Sturdy aprons up to 67mm height prevent items against rolling out



Doors open up to 270° provide easy access to content

Model	Description	Dimensions	Load	Color	Pack
4031	BITBAR® Mobile Work Center with 4-drawer and Cabinet	124.5 × 67.0 × 97.2cm	340kg	BLA	1
4032	BITBAR® Mobile Work Center with 2-door Cabinet	124.5 × 67.0 × 97.2cm	340kg	BLA	1
4033	BITBAR® Mobile Work Center with 8-drawer	124.5 × 67.0 × 97.2cm	340kg	BLA	1

## BITBAR® UTILITY CARTS



### PRODUCT FEATURES:

1. Innovative design for easy transportation of any item.
2. Sturdy structural foam construction won't rust dent, chip, or peel.
3. Molded-in storage compartments and cup holder - suitable for storage of small items and tools.
4. User friendly handles provide comfortable and easy maneuverability.
5. Integrated molded grooves for inserting steel tube or metal reeled coils or other coil-like items.

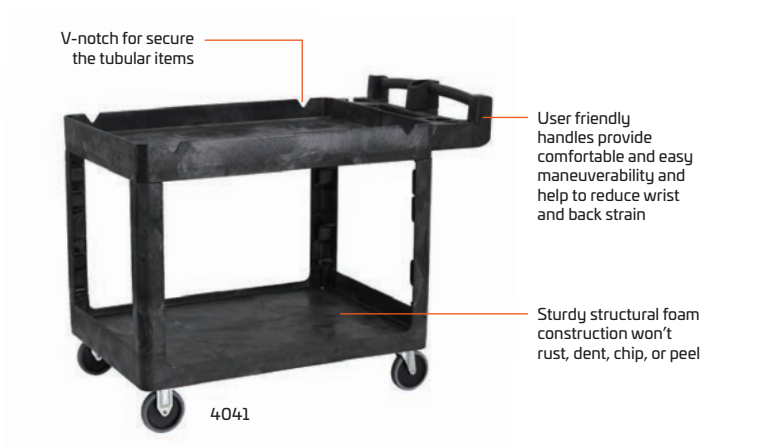

4042



4043



4044



4046

Model	Description	Dimensions	Load	Color	Castor Type	Pack
4041	BITBAR® 2-shelf Utility Cart	115.0 × 64.1 × 98.7cm	230kg	BLA, BEIG	12.5cm TPR	1
4042	BITBAR® Utility Cart with Drawer	115.0 × 64.1 × 98.7cm	230kg	BLA, BEIG	12.5cm TPR	1
4043	BITBAR® 3-shelf Utility Cart	115.0 × 64.1 × 98.7cm	230kg	BLA, BEIG	12.5cm TPR	1
4044	BITBAR® 2-shelf Utility Cart	97.8 × 43.5 × 98.7cm	230kg	BLA, BEIG	12.5cm TPR	1
4046	BITBAR® 3-shelf Utility Cart	97.8 × 43.5 × 98.7cm	230kg	BLA, BEIG	12.5cm TPR	1

## BITBAR® FLAT-SHELF CARTS



### PRODUCT FEATURES:

1. Innovative design for easy transportation of any item.
2. Sturdy structural foam construction won't rust dent, chip, or peel.
3. Molded-in storage compartments and cup holder are suitable for storage of small items and tools.
4. User friendly handles provide comfortable and easy maneuverability.
5. Integrated molded grooves for inserting steel tube or metal reeled coils or other coil-like items.



4047

Model	Description	Dimensions	Load	Color	Castor Type	Pack
4045	BITBAR® 2-shelf Utility Cart Flat Shelf	97.8 × 43.5 × 96.8cm	230kg	BLA, BEIG	12.5cm TPR	1
4047	BITBAR® 3-shelf Utility Cart Flat Shelf	97.8 × 43.5 × 96.8cm	230kg	BLA, BEIG	12.5cm TPR	1

## LADDER CARTS

### PRODUCT FEATURES:

1. For storing and moving 1.8 m ladder without damaging walls, doors or elevators.
2. The cart body is made of commercial grade plastic and galvanized steel. Maximum load up to 250kg.
3. Compact design enhances the operability of the cart, and takes up less space.
4. Cart is ergonomically designed to offer a comfortable working height.
5. The cart is for storage of ladders and other long objects, and fits for a variety of work environments.



Tool case can be used as a worktable once turned over



Tool Holder allows easy access to small tools



Unlock the rail to remove the ladder easily

Model	Description	Dimensions	Load	Color	Pack
4051	Ladder Cart	80.5 × 69.1 × 112.1cm	250kg	BLA	1

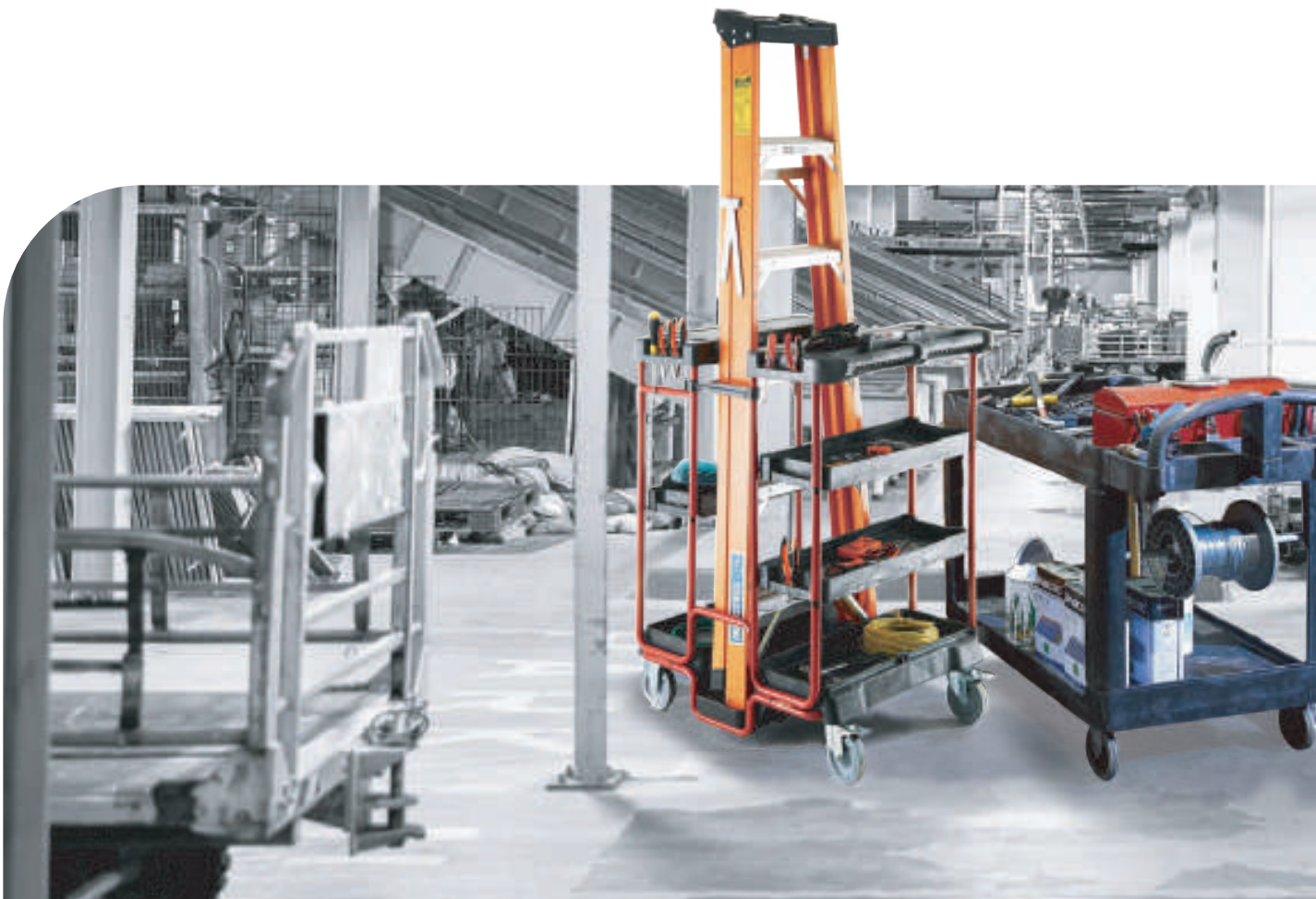

# MATERIAL SUPPLY CARTS



## PRODUCT FEATURES:

1. Ideal choice for storing, counting and collecting goods.
2. Molded fabrication, strength and durability won't rust, dent, chip or peel.
3. Powder-coated steel handle is durable.
4. Various shelf positions available providing additional space for managing and transporting small cartons.
5. Carton recycling unit assures safe and clean aisles.



Various shelf (4063) positions available providing additional space for managing and transporting small cartons

Pre-installed armrest with a small table for easy recording

4821 Storage container, helps store small articles and improve work efficiency

4063/4821/4061



4062



Real-time carton recycling



Molded fabrication, strength and durability won't rust, dent, chip or peel

Model	Description	Dimensions	Load	Color	Pack
4061	Material Supply Cart	163.4 × 45.4 × 163.2cm	810kg	BLA	1
4062	Material Supply Cart	196.0 × 45.4 × 163.2cm	810kg	BLA	1
4063	Shelf for 4061	163.4 × 45.4 × 7.0cm	N/A	BLA	1
4064	Shelf for 4062	196.0 × 45.4 × 7.0cm	N/A	BLA	1
4065	Carton Recovery System	66.5 × 38.2 × 76.5cm	N/A	YEL	1



# PLATFORM TRUCKS

## CASTORS SELECTION GUIDE

**TRUST** carts and trucks use top quality castors to meet every demand.



### PP Castors

PP castors are easier to move than soft castors. They are non-marking, resistant to impact and chemical corrosion, and will neither slide off course, nor suffer damage from metal debris or nails under load. Excellent on concrete, wood, carpet and steel surfaces.

### Pneumatic Castors

Ideal for fragile goods. Allows the trucks to run quietly on uneven rough surfaces as if they are moving across a soft cushion. Excellent on nearly all surfaces, including smooth concrete and rough gravel surfaces.

### TPR Castors

TPR castors help reduce shock, protect the floor and run quietly. Excellent on tiles, Terrazzo, wood, smooth concrete, and carpets.



## CASTORS PERFORMANCE GUIDE

	Environmental Conditions	TPR Castors	PP Castors	Pneumatic Castors
Ground	Asphalt	●●●	●	●●●
	Bricks	●●●	●	●●●
	Carpet	●●●	●●	●●●
	Concrete	●●●	●●	●●●
	Asphalt Felt Ground tile	●●●	●	●●●
	Steel Surface - textured	●●	●	●●●
	Steel Surface - polished	●●	●●	●●●
	Terrazzo	●●●	●	●●●
	Wooden Floor	●●●	●●	●●●
	Transportation Conditions	Moderate Chemicals	●	●●
Serious Chemicals		●	●	●●
Metal Debris - S		●	●●●	●
Metal Debris - L		●	●●	●●
Animal Fat		●●	●●	●●
Grease		●	●●	●
Water and Vapor		●●	●●●	●●
Other Factors		Ground Protection	●●●	●●
	Quiet Transportation	●●●	●	●●●
	Load Buffer	●●	N/A	●●●
	Resistance to Pressure	●●	●●●	●●●
	Rolling Sensibility	●	●●●	●
	Resistance to Wear (Not Damaged)	●	●●	●●●
	No Extreme Wear (Under Static Load)	●	●●●	●●

## Advanced Structural Foam Technology

- New technology, low pressure injection molding has no internal stress.
- Optimized composite structure of surface and core layers provides improved bend resistance per cross-section and increased stiffness of structural components.
- Honeycomb core layer has good cushioning performance and better impact resistance.
- Blend structure of plastic and metal has the carrying capacity 50-60% higher than that of traditional products.



## World-class Durability

- When it comes to durability TRUST carts outperform industry peers.
- TRUST platform trucks have a unique design to ensure a long life and to make the job of operators easier.

## Multiple Solutions

- We offer multiple products in different sizes to meet a wide variety of demands.



# PLATFORM TRUCKS



## OEASY® PLATFORM TRUCKS

### PRODUCT FEATURES:

1. Perfect for transporting heavy loads in any environment.
2. User friendly handles help to maneuver the cart and ensure the safety of operators.
3. Molded-in structure adds strength and durability, and prolongs the service life.
4. Textured surfaces for non-skid and safe transporting.
5. Grooves close to edges help prevent small items from rolling out.
6. Notches on both sides are for secure latch of items.
7. Flexible fixing clip helps to prevent accidental release of handle while allowing easy disassembly.
8. Durable Powder-coated steel handle.



4411

Notches on both sides help latch items securely

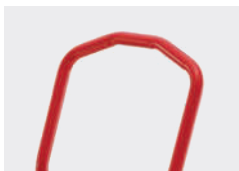

Durable Powder-coated steel handle



User friendly handles help to maneuver the cart and ensure the safety of operators



Grooves close to edges help prevent small items from rolling out



Textured surfaces for non-skid and safe transporting



Flexible fixing clip helps to prevent accidental release of handle while allowing easy disassembly

Model	Description	Deck Size	Dimensions	Load	Castor Type	Pack
4411	OEASY® Platform Trucks	91.4 × 61.0cm	101.9 × 61.0 × 100.6cm	450kg	15.0 × 5.0cm TPR	1
4412	OEASY® Platform Trucks	91.4 × 61.0cm	101.9 × 61.0 × 100.6cm	900kg	15.0 × 5.0cm PP	1
4413	OEASY® Platform Trucks	121.9 × 61.0cm	132.4 × 61.0 × 105.7cm	900kg	20.0 × 5.0cm TPR	1
4414	OEASY® Platform Trucks	121.9 × 61.0cm	132.4 × 61.0 × 107.0cm	540kg	20.0 × 5.0cm Pneumatic	1
4415	OEASY® Platform Trucks	121.9 × 61.0cm	132.4 × 61.0 × 105.7cm	1130kg	20.0 × 5.0cm PP	1
4416	OEASY® Platform Trucks	152.4 × 76.2cm	162.9 × 76.2 × 105.7cm	900kg	20.0 × 5.0cm TPR	1
4417	OEASY® Platform Trucks	152.4 × 76.2cm	162.9 × 76.2 × 107.0cm	540kg	20.0 × 5.0cm Pneumatic	1
4418	OEASY® Platform Trucks	152.4 × 76.2cm	162.9 × 76.2 × 105.7cm	1130kg	20.0 × 5.0cm PP	1

## OEASY® A-FRAME PANEL TRUCKS



### PRODUCT FEATURES:

1. Designed for transporting bulky plate-like items and difficult-to-move items, such as doors, wood, stone slab, tabletop and wardrobes, etc.
2. Molded-in structure adds strength and durability, and prolongs the service life.
3. Textured surfaces for non-skid and safe transporting.
4. Grooves close to edges help prevent small items from rolling out.
5. Notches on both sides help latch items securely.
6. Flexible fixing clip helps to prevent accidental release of handle while allowing easy disassembly.
7. Durable Powder-coated steel handle.



Model	Description	Deck Size	Dimensions	Load	Castor Type	Pack
4421	OEASY® A-Frame Panel Trucks	91.4 × 61.0cm	98.4 × 61.0 × 109.2cm	900kg	15.0 × 5.0cm PP	1
4422	OEASY® A-Frame Panel Trucks	121.9 × 61.0cm	128.9 × 61.0 × 114.0cm	900kg	20.0 × 5.0cm PP	1
4423	OEASY® A-Frame Panel Trucks	152.4 × 76.2cm	159.4 × 76.2 × 114.0cm	900kg	20.0 × 5.0cm PP	1

## OEASY® SHEET & PANEL TRUCKS



### PRODUCT FEATURES:

1. Designed for transporting bulky plate-like items and difficult-to-move items, such as doors, wood, stone slab, tabletop and wardrobes, etc.
2. Molded-in structure adds strength and durability, and prolongs the service life.
3. Three removable power-coated steel vertical frames provide support for bulky loads. Frames can be removed as needed based on load requirements.
4. Textured surfaces for non-skid and safe transporting.
5. Grooves close to edges help prevent small items from rolling out.
6. Notches on both sides help latch items securely.
7. Flexible fixing clip helps to prevent accidental release of handle while allowing easy disassembly.
8. Durable Powder-coated steel handle.



Model	Description	Deck Size	Dimensions	Load	Castor Type	Pack
4431	OEASY® Sheet & Panel Trucks	91.4 × 61.0cm	98.4 × 61.0 × 109.2cm	900kg	15.0 × 5.0cm PP	1
4432	OEASY® Sheet & Panel Trucks	121.9 × 61.0cm	128.9 × 61.0 × 114.0cm	900kg	20.0 × 5.0cm PP	1
4433	OEASY® Sheet & Panel Trucks	152.4 × 76.2cm	159.4 × 76.2 × 114.0cm	900kg	20.0 × 5.0cm PP	1

## OEASY® WORK HEIGHT PLATFORM TRUCKS



### PRODUCT FEATURES:

1. User-friendly cart is unique with height adjustable capacity to suit the operator.
2. Three height options ranging from 73cm to 88cm with an interval of 7.5cm are available for the work surface height.
3. User friendly handles help to maneuver the cart and ensure the safety of operators.
4. Molded-in structure adds strength and durability, and prolongs the service life.
5. Textured surfaces for non-skid and safe transporting.
6. Grooves close to edges help prevent small items from rolling out.
7. Notches on both sides are for secure latch of items.
8. Flexible fixing clip helps to prevent accidental release of handle while allowing easy disassembly.
9. Powder-coated steel handle is durable.
10. Two directional castors plus two universal castors ensure easy maneuverability.

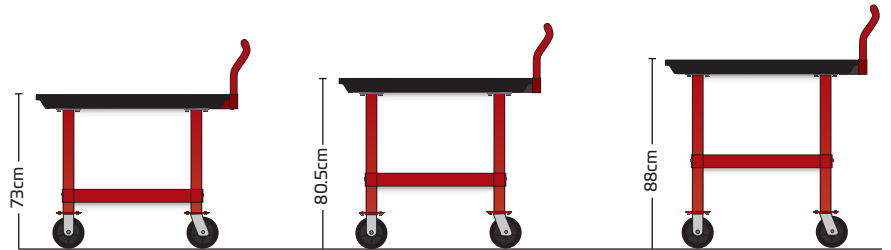

Three height options ranging from 73cm to 88cm with an interval of 7.5cm are available for different work surface heights.



Unique User-friendly cart with adjustable height to suit the user



Textured surfaces for non-skid and safe transporting



Flexible fixing clip helps to prevent accidental release of handle while allowing easy disassembly

Model	Description	Deck Size	Dimensions	Load	Castor Type	Pack
4441	OEASY® Work Height Platform Trucks	91.4 × 61.0cm	98.4 × 61.0 × 114.0cm	900kg	15.0 × 5.0cm TPR	1
4442	OEASY® Work Height Platform Trucks	121.9 × 61.0cm	128.9 × 61.0 × 119.1cm	900kg	20.0 × 5.0cm TPR	1
4443	OEASY® Work Height Platform Trucks	152.4 × 76.2cm	159.4 × 76.2 × 119.1cm	900kg	20.0 × 5.0cm TPR	1



## OEASY® STANCHION PLATFORM TRUCKS



### PRODUCT FEATURES:

1. Designed for transporting long and heavy pipes, wood and rolled stock, etc..
2. Molded-in structure adds strength and durability, and prolongs the service life.
3. Textured surfaces for non-skid and safe transporting.
4. Grooves close to edges help prevent small items from rolling out.
5. Notches on both sides help latch items securely.
6. Flexible fixing clip helps to prevent accidental release of handle while allowing easy disassembly.
7. Two directional castors plus two universal castors ensure easy maneuverability.



Model	Description	Deck Size	Dimensions	Load	Castor Type	Pack
4451	OEASY® Stanchion Platform Truck	91.4 × 61.0cm	98.4 × 61.0 × 103.2cm	1130kg	15.0 × 5.0cm PP	1
4452	OEASY® Stanchion Platform Truck	121.9 × 61.0cm	128.9 × 61.0 × 108.0cm	1130kg	20.0 × 5.0cm PP	1
4453	OEASY® Stanchion Platform Truck	152.4 × 76.2cm	159.4 × 76.2 × 108.0cm	1130kg	20.0 × 5.0cm PP	1

## OEASY® SKID PLATFORM TRUCKS



### PRODUCT FEATURES:

1. An ideal choice for moving, temporary storing and supplementing materials.
2. Molded construction adds to strength, durability and extended service life.
3. Textured non-slip surface for added safety.
4. There are two notches on both sides of platform for latching of objects to enhance security.
5. Mobile jack handle is Powder-coated and durable; designed with a large steering angle to fit tight spaces.
6. Jack handle is sold separately.



Model	Description	Deck Size	Dimensions	Load	Castor Type	Pack
4471	OEASY® Skid Platform Truck	91.4 × 61.0cm	96.5 × 61.0 × 31.8cm	900kg	20.0 × 5.0cm TPR	1
4472	OEASY® Skid Platform Truck	122.0 × 61.0cm	127.0 × 61.0 × 31.8cm	900kg	20.0 × 5.0cm TPR	1
4473	OEASY® Skid Platform Truck	152.0 × 76.0cm	157.0 × 76.0 × 31.8cm	900kg	20.0 × 5.0cm TPR	1
4474	OEASY® Skid Platform Jack Handle	N/A	127.0 × 29.8 × 26.0cm	900kg	20.0 × 5.0cm TPR	1



# PLATFORM TRUCKS

## OEASY® PANEL PLATFORM TRUCKS



### PRODUCT FEATURES:

1. Designed to deliver small parcels and objects.
2. Powder-coated wire cage around the truck ensures effective protection of goods carried.
3. Cage is removable to allow for transporting jumbo sized objects.
4. User-friendly handrails for easy maneuverability and improved worker safety.
5. Sturdy and durable structural foam construction adds to the durability and service life of the cart.
6. Designed with elastic retaining clip to effectively prevent the handrail from coming off; and offers easy disassembly/assembly.
7. Durable Powder-coated steel handle.
8. Two directional castors plus two universal castors ensure easy maneuverability.



Wire cage sides are easy to dismantle for accommodating objects of various sizes

Model	Description	Deck Size	Dimensions	Load	Castor Type	Pack
4461	OEASY® Panel Platform Trucks	91.4 × 61.0cm	111.8 × 61.0 × 99.7cm	450kg	15.0 × 5.0cm TPR	1
4462	OEASY® Panel Platform Trucks	121.9 × 61.0cm	142.2 × 61.0 × 105.4cm	550kg	20.0 × 5.0cm Pneumatic	1
4463	OEASY® Panel Platform Trucks	121.9 × 61.0cm	142.2 × 61.0 × 104.8cm	900kg	20.0 × 5.0cm TPR	1
4464	OEASY® Panel Platform Trucks	152.4 × 76.2cm	173.0 × 76.2 × 105.4cm	550kg	20.0 × 5.0cm Pneumatic	1
4465	OEASY® Panel Platform Trucks	152.4 × 76.2cm	173.0 × 76.2 × 104.8cm	900kg	20.0 × 5.0cm TPR	1

## UTILITY TROLLEYS



### PRODUCT FEATURES:

1. Efficiently transports large bulky loads, and then folds flat for easy storage.
2. Sturdy structural foam deck won't rust, dent, chip, or peel.
3. Non-skid platform surface helps prevent loads from shifting.
4. Three-position handle lets users push, pull or fold flat for use as a dolly.
5. Non marking castors.



Three handle positions provide greater flexibility, and convenient storage



Model	Description	Dimensions	Load	Color	Pack
4481	Utility Trolley, Utility Duty with 7.5cm Castors	85.0 × 52.1cm	110kg	BLA	1
4482	Utility Trolley, Standard Duty with 12.5cm Castors	85.0 × 52.1cm	230kg	BLA	1

# TOTES TROLLEYS



## PRODUCT FEATURES:

1. Maneuverability for carrying heavy objects.
2. Sturdy structural foam construction won't rust, dent, chip, or peel.
3. Non-marking swivel castors ensure easy maneuverability.
4. Use 4483 to load Large Totes (3011/3012) and 55.5 × 35.0cm Containers.
5. Use 8888 used to load 60.0 × 40.0cm Containers.
6. Use 8889 to load 69.0 × 49.0cm Containers.



Maneuverability for carrying heavy objects



Stackable for easy storage and space saving

Model	Description	Dimensions	Load	Color	Pack
4483	Totes Trolley	63.0 × 43.5 × 18.5cm	150kg	BLA	1
8888	Totes Trolley	67.6 × 43.6 × 17.3cm	150kg	BLA	1
8889	Totes Trolley	75.5 × 51.7 × 16.5cm	150kg	BLA	1



# CUBE TRUCKS



## CUBE TRUCKS

### PRODUCT FEATURES:

1. For waste collection, material transport and laundry handling.
2. Rotomolded, industrial-grade strength, transports heavy loads with ease.
3. Metal frame provides durable support.



**Domed, hinged lid** conceals loads without reducing capacity



4711



4712

Model	Description	Dimensions	Load	Color	Pack
4710	0.2m <sup>3</sup> Cube Truck	98.0 × 72.0 × 76.0cm	135kg	BLA	2
4711	0.3m <sup>3</sup> Cube Truck	114.5 × 75.0 × 88.0cm	180kg	GRN, RED, YEL, WHT, BLA	2
4712	0.3m <sup>3</sup> Heavy-duty Utility Truck	114.5 × 75.0 × 89.3cm	360kg	BLA	2
4713	Lid for 4711/4712	113.0 × 70.5 × 13.2cm	N/A	BLA	1
4714	0.4m <sup>3</sup> Cube Truck	117.0 × 84.0 × 86.0cm	230kg	BLA	2
4715	0.5m <sup>3</sup> Cube Truck	125.5 × 92.0 × 94.0cm	230kg	BLA	2



# TILT TRUCKS



## ROTOMOLDED TILT TRUCKS

### PRODUCT FEATURES:

1. Fits through standard commercial doorways and onto elevators easily.
2. Angled design of the front end assists in emptying.
3. Industrial strength trucks handle heavy loads with ease.
4. Insert wheel position helps prevent damage to walls, equipment and customers.
5. Smooth surfaces are easy to clean and resist corrosion.
6. Optional hinged domed lid available.



4512

4522

Model	Description	Dimensions	Load	Color	Pack
4512	Tilt Truck	183.2 × 85.1 × 111.4cm	270kg	BLA	1
4522	Tilt Truck, Utility Duty	183.2 × 85.1 × 111.4cm	390kg	BLA	1

## HEAVY-DUTY TOWABLE TILT TRUCKS

### PRODUCT FEATURES:

1. Heavy-duty tow bar, hitch and frame for multiple truck towing and training.
2. Pneumatic wheels for smooth movement over various terrain surfaces or stairs.



4532

Model	Description	Dimensions	Load	Color	Pack
4532	Heavy-duty Towable Tilt Truck	183.2 × 85.1 × 111.4cm	950kg	BLA	1

## HEAVY-DUTY FORKLIFTABLE TILT TRUCKS

### PRODUCT FEATURES:

1. Fully compatible with forklifts.
2. Multi-purpose, durable, welded fork pockets.



4542

Model	Description	Dimensions	Load	Color	Pack
4542	Heavy-duty Forkliftable Tilt Truck	183.2 × 85.1 × 111.4cm	570kg	BLA	1

## STRUCTURAL FOAM TILT TRUCKS

### PRODUCT FEATURES:

1. Molded construction adds to strength, transports heavy loads with ease.
2. Easy access to standard doors and lifts.
3. Non-marking wheels prevent floor marking and reduce the post-job clean-up.
4. Easily operated by a single person.
5. Easy to clean, maintenance-free.
6. Optional hinged domed lid available.



4612



4614

Model	Description	Dimensions	Capacity	Load	Color	Pack
4611	Tilt Truck, Utility Duty	145.7 × 68.3 × 86.1cm	0.4m <sup>3</sup>	200kg	BLA	1
4612	Tilt Truck, Standard Duty	145.7 × 68.3 × 86.1cm	0.4m <sup>3</sup>	380kg	BLA	1
4613	Tilt Truck, Utility Duty	163.8 × 76.8 × 96.5cm	0.6m <sup>3</sup>	270kg	BLA	1
4614	Tilt Truck, Standard Duty	163.8 × 76.8 × 96.5cm	0.6m <sup>3</sup>	450kg	BLA	1



## TILT TRUCK COVERS

### PRODUCT FEATURES:

1. Rotomolded, industrial-grade strength, sturdy and durable.
2. Foldable, easy to stock.



Model	Description	Dimensions	Capacity	Color	Pack
4513	Cover for 4512/4522/4532/4542	183.2 × 85.1 × 21.5cm	N/A	BLA	1
4615	Cover for 4611/4612	132.1 × 70.8 × 22.9cm	N/A	BLA	1
4616	Cover for 4613/4614	154.9 × 80.6 × 22.9cm	N/A	BLA	1

## COLLAPSIBLE LINEN CARTS

### PRODUCT FEATURES:

1. Suitable for collecting and transporting non-sharp items and laundries, etc.
2. Compact, collapsible frame reduces space by 73% to enable efficient storage and transport.
3. Durable, lightweight and easy to control.
4. Non-marking swivel castors allow easy movement in narrow spaces, providing quiet operation and minimizing floor repair work.
5. Bumpers available at four corners to protect walls and equipment.
6. Durable Powder-coated steel frame.
7. Sturdy and durable vinyl bag, easy to clean.
8. Specially designed trailer function can connect multiple carts to improve transportation efficiency.
9. Cover is sold separately.

## COVER

### PRODUCT FEATURES:

1. High quality vinyl cover, easy to clean.
2. Built-in storage bag allows convenient storage of various cleaning tools.
3. Zipper on the top provides easy access to the items inside without removing the cover.



Model	Description	Dimensions	Capacity	Color	Pack
5088	Collapsible Linen Cart	65.2 × 53.8 × 82.0cm	120L	GRAY	1
5089	Collapsible Linen Cart	76.7 × 64.2 × 82.0cm	200L	GRAY	1
5090	Collapsible Linen Cart	94.2 × 64.2 × 82.0cm	240L	GRAY	1
5091	Cloth/Straw Bag, for 5088	52.0 × 40.0 × 60.0cm	120L	BLA	2
5092	Cloth/Straw Bag, for 5089	67.0 × 51.0 × 60.0cm	200L	BLA	2
5093	Cloth/Straw Bag, for 5090	80.2 × 51.0 × 60.0cm	240L	BLA	2
5094	Cover for 5088	56.0 × 45.0 × 23.0cm	N/A	BLA	2
5097	Cover for 5089	68.0 × 55.0 × 23.0cm	N/A	BLA	2
5098	Cover for 5090	85.0 × 55.0 × 23.0cm	N/A	BLA	2

147282	CH4 UTE 4	A	0
78			0
Team Alert	15	11	00:58
Defekti	0%	0	0
12:16:22			Sunday 02/23/2012



# UTILITY SERVICE CARTS



## HIS® UTILITY SERVICE CARTS

### PRODUCT FEATURES:

1. Versatile, durable for indoor mobility.
2. Molded shelves won't rust, dent, peel.
3. Aluminum uprights engineered for durability and appearance.
4. Convenient handles located on each end and compact size enhance maneuverability.
5. Quiet, non-marking swivel castors.
6. Non-slip surface texture.



Convenient **handles located on each end** and compact size enhance maneuverability



All-plastic molded shelves engineered for durability, **Textured surface** for non-slip performance



Convenient **handles** located on each end and compact size enhance maneuverability



Specially configured **end caps** for easy fitting of bins



Quiet, non-marking **swivel castors**

Model	Description	Dimensions	Load	Color	Pack
4010	HIS® Utility Cart, 2-shelf Unit	85.4 × 47.3 × 96.0cm	60kg	GRAY, BLA, PLAT, OWHT	1
4011	HIS® Utility Cart, Open Sided	85.4 × 47.3 × 96.0cm	90kg	GRAY, BLA, PLAT, OWHT	1
4012	HIS® Utility Cart with Enclose End Panels on 2 Sides	85.4 × 47.3 × 96.0cm	90kg	BLA, PLAT	1
4013	HIS® Utility Cart with Lockable Doors, Sliding Drawer	85.4 × 47.3 × 96.0cm	90kg	BLA	1

# H15<sup>®</sup> UTILITY SERVICE CARTS

## PRODUCT FEATURES:

1. Versatile, durable for indoor mobility.
2. Molded shelves won't rust, dent, peel.
3. Aluminum uprights engineered for durability and appearance.
4. Convenient handles located on each end and compact size enhance maneuverability.
5. Quiet, non-marking swivel castors.
6. Non-slip surface texture.
7. Large shelves suitable for a variety of equipment and supplies.



4021



4022



4023



4024



4025



4026



All-plastic molded shelves engineered for durability, Textured surface for non-slip performance



Specially configured end caps for easy fitting of bins



Quiet, non-marking swivel castors

Model	Description	Dimensions	Load	Color	Pack
4020	H15 <sup>®</sup> Utility Cart, 2-Shelf Unit	103.2 × 50.8 × 96.0cm	90kg	BLA	1
4021	H15 <sup>®</sup> Utility Cart, Open Sided	103.2 × 50.8 × 96.0cm	135kg	GRAY, BLA, OWHT	1
4022	H15 <sup>®</sup> Utility Cart with Enclosed End Panels on 2 Sides	103.2 × 50.8 × 96.0cm	135kg	BLA, OWHT	1
4023	H15 <sup>®</sup> Utility Cart with Enclosed End Panels on 3 Sides	103.2 × 50.8 × 96.0cm	135kg	BLA, OWHT	1
4024	H15 <sup>®</sup> Utility Cart with Lockable Doors, Sliding Drawer	103.2 × 50.8 × 96.0cm	135kg	GRAY	1
4025	H15 <sup>®</sup> Equipment Cart	103.2 × 50.8 × 96.0cm	135kg	BLA	1
4026	H15 <sup>®</sup> 4 Shelf Cart	103.2 × 50.8 × 129.5cm	135kg	BLA	1
4027	H15 <sup>®</sup> Utility Cart with two sets of Lockable Doors	103.2 × 50.8 × 96.0cm	135kg	BLA	1

## HI5® FOLDING SERVICE CARTS

### PRODUCT FEATURES:

1. Versatile, durable for indoor mobility.
2. Molded shelves sturdy and durable won't rust, dent, peel.
3. Fully functional and innovative folding mechanism can be easily folded and opened, saving 50% of the space once folded.
4. Quick locking device to ensures cart remains in position after opening or folding.
5. Comfortable ergonomic handle for more flexible control.
6. Textured surfaces for non-slip and safe transportation.
7. Spacious countertop for the 4072 cart, which can place two bus boxes (8221) at the same time.
8. 10cm silent no-marking castors which is designed to reduce noise and floor wear and tear; Universal wheel with brake function for stability when working.



Comfortable ergonomic handle for more flexible control



Quick locking device to ensures cart remains in position after opening or folding



Innovative folding mechanism makes it easier to open and fold



10cm quiet, non-marking castors

Model	Description	Dimensions	Load	Color	Pack
4071	HI5® Foldable Service Cart	75.0 × 41.2 × 92.0cm	160kg	GRAY, BLA, BRN	1
4072	HI5® Foldable Service Cart	102.5 × 52.3 × 92.0cm	160kg	GRAY, BLA, BRN	1



## HI5® UTILITY SERVICE CARTS



### PRODUCT FEATURES:

1. Sturdy and durable, fully functional carts, suitable for handling work in the front and back of house.
2. The sturdy and durable structure of the entire cart is form molded, and will not rust, dent or come apart.
3. Ergonomic, comfortable handle provides flexible control.
4. Textured surfaces for non-slip and safe transportation.
5. With a spacious countertop, two lower railing basins can be placed side by side (8211).
6. 10cm silent no-marking castors which is designed to reduce noise and floor wear and tear.
7. The sundries barrels (4811, 4821) can be placed on both sides to increase collection capacity.



4081



4082



4083



4084

Model	Description	Dimensions	Load	Color	Pack
4081	HI5® Utility Cart	111.6 × 54.0 × 95.6cm	135kg	BLA	1
4082	HI5® Utility Cart with Enclosed End Panels on 3 Sides	111.6 × 54.0 × 95.6cm	135kg	BLA	1
4083	HI5® Utility Cart with Lockable Doors, Sliding Drawer	111.6 × 54.0 × 95.6cm	135kg	BLA	1
4084	HI5® Utility Cart with Lockable Doors, Enclosed Panels	111.6 × 54.0 × 95.6cm	135kg	BLA	1

## ACCESSORIES



4811



4821



4851

Model	Description	Dimensions	Capacity	Color	Pack
4085	Enclosed Panels	N/A	N/A	BLA	1
4086	Lockable Doors	N/A	N/A	BLA	1
4087	Trim Panel	50.6 × 30.8 × 3.7cm	N/A	BLA	1
4811	Utility Bin	43.2 × 30.8 × 26.7cm	15L	BLA	2
4821	Utility Bin	43.2 × 30.8 × 55.9cm	30L	BLA	2
4851	Utility Sliding Drawer	65.7 × 46.0 × 8.2cm	N/A	BLA, BRN	1

# CART ACCESSORIES

## CART ACCESSORIES SELECTION GUIDE

Cart Model	4811 15L Utility Bin Pack: 2 Color: BLA	4821 30L Refuse Bin Pack: 2 Color: BLA	4830 Hook Kit (Set of 4) Pack: 1 Color: BLA	4831 20cm Pneumatic Castor Kit Pack: 1	4832 Ultra Silent Castor Kit (Set of 4) Pack: 1 Color: GRAY	4841 Single Full Extension Drawer Pack: 1 Color: RED	4850 Utility Sliding Drawer Pack: 1 Color: BLA	4851 Utility Sliding Drawer Pack: 1 Color: BRN, BLA
4011	●	●	●		●		●	
4012	●	●	●		●		●	
4013	●	●	●		●		●	
4021	●	●	●		●			●
4022	●	●	●		●			●
4023	●	●	●		●			●
4024	●	●	●		●			●
4025	●	●	●		●			●
4026	●	●	●		●			●
4031	●	●	●	●				
4032	●	●	●	●				
4033	●	●	●	●				
4041	●	●	●	●		●		
4042	●	●	●	●		●		
4043	●	●	●	●		●		
4044	●	●	●	●				
4045				●				
4046	●	●		●				
4047				●				
4061	●	●		●				
4062	●	●		●				
4081	●	●	●					●
4082	●	●	●					●
4083	●	●	●					●
4084	●	●	●					●







## SHELVING SYSTEMS

### PRODUCT FEATURES:

1. Store, organize and transport in style with these durable, and attractive shelving units.
2. Stationary shelves feature molded feet for added stability.
3. Mobile shelf trucks come with 4 castors (two with brake).
4. Locking doors are optional for 3711, 3712, 3715, 3716.
5. Units are available with four, five or six shelves and a variety of heights up to 184cm.
6. Shelves feature aluminum uprights for smart appearance and durability.
7. Steel bar reinforced molded shelves support higher loads.
8. Textured shelves have higher load capacity.
9. Large shelves can hold a variety of equipment and supplies.



3716

3717



Enclosed panels (3719) and lockable doors (3718) are available for 3711/3712/3715/3716



3711



3712



3713



3714



3715

Model	Description	Dimensions	Load	Color	Pack
3711	Shelving, 4-shelf Unit	89.2 × 50.8 × 116.0cm	360kg	BLA	1
3712	Shelving, 5-shelf Unit	89.2 × 50.8 × 150.0cm	360kg	BLA	1
3713	Shelving, 4-shelf Unit	89.2 × 50.8 × 180.0cm	360kg	BLA	1
3714	Shelving, 5-shelf Unit	89.2 × 50.8 × 180.0cm	360kg	BLA	1
3715	Shelving, 6-shelf Unit	89.2 × 50.8 × 184.0cm	360kg	BLA	1
3716	Mobile Shelf Truck, 5-shelf Unit	89.2 × 50.8 × 153.0cm	360kg	BLA	1
3717	Mobile Shelf Truck, 4-shelf Unit	89.2 × 50.8 × 184.0cm	360kg	BLA	1
3718	Lockable Doors for 3711/3712/3715/3716/4021/4026	N/A	N/A	BLA	1
3719	Enclosed Panels for 3711/3712/3715/3716/4021/4026	N/A	N/A	BLA	1

## BITBAR® TOOL BOXES

### PRODUCT FEATURES:

1. Removable trays provide added compartmentalized storage area.
2. Padlocked for security.
3. 3512 has a 3cm cushion on the top of box to provide a comfortable seat.
4. Handles are provided on both sides of 3511/3512, and optional castors (3513) are convenient for moving heavy objects.
5. 3514 has diverse compartments, for the orderly storage of a variety of tools with a transparent cover for quick identification of the items inside.



Built-in **two sub-grid boxes**, for easy storage



3512 with 3cm thick **comfortable cushion**



**Parts box** with transparent cover at both ends



3514 has compartments, which can be adjusted according to the tool size

Model	Description	Dimensions	Load	Color	Pack
3511	Tool Box	91.6 × 47.0 × 50.9cm	135kg	BLA	1
3512	Tool Box with Cushion	91.6 × 47.0 × 53.9cm	135kg	BLA	1
3513	Castor Kit (4 Units)	Dia 7.5 × 2.0cm	135kg	BLA	1
3514	Multi-purpose Tool Box	45.8 × 33.0 × 8.0cm	N/A	BLA	1

## THOR® LARGE TOTES WITH LID



### PRODUCT FEATURES:

1. Reinforced ribbed bottom allows product to be dragged.
2. User friendly grip handles decrease the potential of hand injury.
3. Lid snaps tight, keeping contents secure.
4. Works with dollies for carrying heavy loads quickly and conveniently.



Works with **dollies** to carrying heavy loads fast and convenient



3011/3012

Model	Description	Dimensions	Capacity	Color	Pack
3011	Tote With Lid	70.8 × 43.4 × 27.2cm	53L	GRAY, WHT	6
3012	Tote With Lid	70.8 × 43.4 × 38.4cm	75L	GRAY, WHT	6
4483	Totes Trolley	63.0 × 43.5 × 18.5cm	N/A	BLA	1

## THOR® STACKABLE TOTE BINS



### PRODUCT FEATURES:

1. Fits 120 × 100cm pallets with no overhang.
2. Nestable for efficient storage and transport.
3. Stackable with and without lids.
4. All-plastic construction will not rust, dent, chip, or peel.
5. Complies with the requirements of NSF #2.



3021



3022/3023

Model	Description	Dimensions	Capacity	Color	Pack
3021	Stackable Tote Bin	59.2 × 39.2 × 27.0cm	40L	GRAY	6
3022	Stackable Tote Bin	59.2 × 39.2 × 36.0cm	55L	GRAY	6
3023	Lid for 3021/3022	60.0 × 40.0 × 3.3cm	N/A	GRAY	6



## MULTI-FUNCTION LADDERS

### PRODUCT FEATURES:

1. Complies with the requirements of ANSI 14.2, AS/NZS 1892.1 and EN-131.
2. Patented auto-locking hinge design.
3. Triple modes of A-shaped ladder, straight ladder and extension ladder.
4. Made with premium quality lightweight aluminum, with outstanding strength and durability.
5. Non-slip step design for safety.
6. Reliable soft tips.
7. Can be folded to one quarter of extended length to save space and transportation costs.
8. Can be extended to four times of length.



### 6945 Schematic Work Status

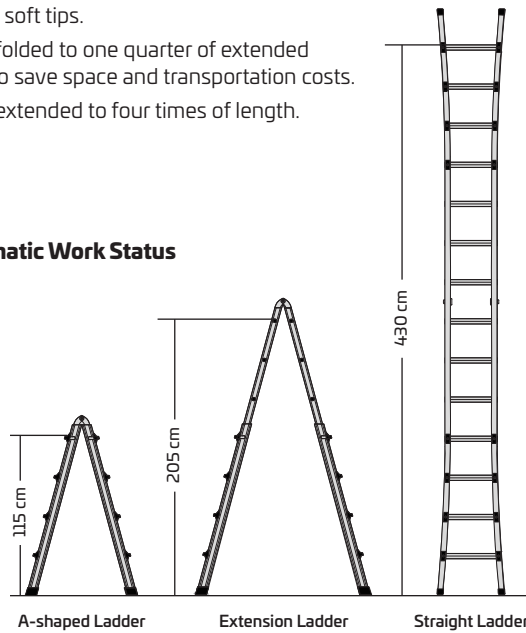

Can be quickly converted into a **straight ladder**, offers high operating convenience



Can be **used on the stairs**, safe and reliable

Model	Description	Dimensions	Extension Length	Folding Length	Load	Color	Pack
6945	Multi-function Ladder	131.0 × 60.5 × 20.0cm	452.0cm	220.0cm	150kg	MSILV	1
6946	Multi-function Ladder	198.0 × 75.0 × 20.0cm	686.0cm	334.0cm	150kg	MSILV	1

## FOLDING LADDERS

### PRODUCT FEATURES:

1. Made by premium quality lightweight aluminum, with outstanding strength and durability.
2. Can be folded down easily and quickly, compactable for space saving.
3. Non-slip step design for enhanced safety.
4. Reliable foot pads.



Model	Description	Dimensions	Load	Color	Pack
6943	Two-step Folding Ladder	Open: 46.0 × 47.0 × 92.0cm Closed: 46.0 × 15.2 × 98.5cm	120kg	BLA	1
6944	Three-step Folding Ladder	Open: 51.0 × 63.5 × 116.0cm Closed: 51.0 × 15.2 × 123.5cm	120kg	BLA	1

## FOLDING STEPSTOOLS

### PRODUCT FEATURES:

1. Slip resistant surfaces on steps and foot pads.
2. Easy to transport and space efficient with folded size only 15.9cm.
3. Plastic molded web-structure, supports loads up to 150kg.
4. Easy to clean and resistant to dents and rest.
5. Meets EN14183:2003 standards.



6932



Easy to transport

Model	Description	Dimensions	Load	Color	Pack
6932	Two-step Folding Stepstool	Open: 47.5 × 51.5 × 59.0cm Closed: 47.5 × 15.9 × 65.0cm	150kg	GRAY, DGRAY, BLA	3

## MOVABLE PEDALS

### PRODUCT FEATURES:

1. Compression castors for easy mobility.
2. Load bearing up to 160kg.
3. Both pedals are equipped with a soft non-slip pad.
4. Castors retract automatically under load.
5. Heavy-duty plastic structure, solid and durable, and will not damage walls or furniture.
6. Meets EN14183:2003 standards.



6933

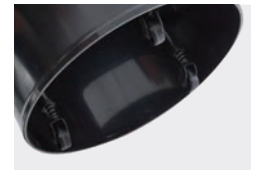

Compression castors for easy mobility

Model	Description	Dimensions	Load	Color	Pack
6933	Movable Two-step Pedal	40.6 × 34.3cm	160kg	BLA, BEIG	1

## ROTMOLDED PLASTIC PEDALS

### PRODUCT FEATURES:

1. Rotomolded; industrial-grade; sturdy and durable.
2. One-piece body construction provides superior strength and durability.
3. All pedals are equipped with a soft non-slip pad.
4. Load bearing up to 160kg.
5. Rubber base pad with anti-skid function for increased security.
6. Four direction pedal design, easy to use.
7. Meets EN14183:2003 standards.



6930

Model	Description	Dimensions	Load	Color	Pack
6930	Rotomolded Plastic Pedal	49.0 × 49.0 × 36.4cm	160kg	YEL, BLA	1

## STORAGE PALLETS

### PRODUCT FEATURES:

1. For overflow operation as drum filling and sub-packaging, chemical and electrolyte storage etc.
2. Prevents leakages of most chemicals including acids, alkaline and corrosive liquids.
3. Molded construction adds to strength, strong and durable, will not rust, dent, chip, or peel.
4. Removable grid for gathering leaked fluids.
5. Optional 4503 slopes for handling heavy drums; rubber strips on surface assure safety.
6. Non-forklifting; no IBC containers allowed.



4501/4502/4503



4501



4502

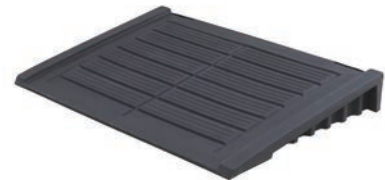

4503

Model	Description	Dimensions	Static Load	Capacity	Color	Pack
4501	Storage Pallet, for 2 Drums	124.5 × 63.5 × 14.0cm	1130kg	90L	BLA	1
4502	Storage Pallet, for 4 Drums	124.5 × 124.5 × 14.0cm	2260kg	185L	BLA	1
4503	Slope, for 4501 and 4502	121.9 × 83.8 × 15.9cm	450kg	N/A	BLA	2

## GOODS SHELVES



### PRODUCT FEATURES:

1. Designed for storage of frozen, refrigerated or dry goods.
2. Structural foam molding ensures strength and durability.
3. Hollow pad offers maximized ventilation for perishable or dry goods.
4. Pad height meets NSF standards.
5. 4491 and 4493 Lock catches can lock goods shelves together for increased stability.



4491

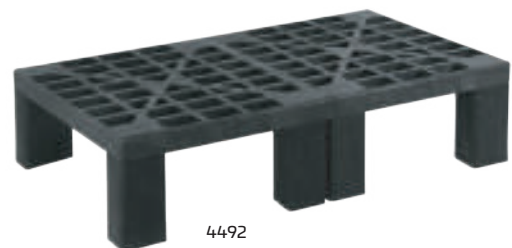

4492



Lock catches can lock goods shelves together for increased stability

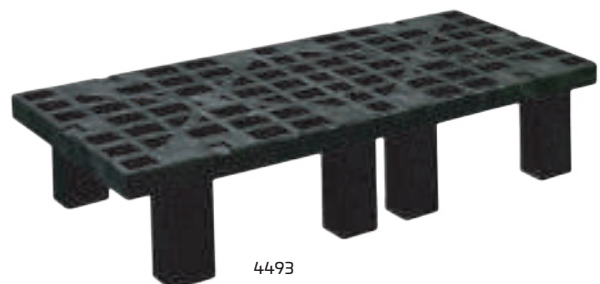

4493

Model	Description	Dimensions	Load	Color	Pack
4491	Goods Shelf	91.0 × 53.3 × 30.5cm	680kg	BLA	1
4492	Goods Shelf	122.0 × 61.0 × 30.5cm	900kg	BLA	1
4493	Goods Shelf	152.0 × 53.3 × 30.5cm	1360kg	BLA	1



## NESTABLE PALLETS

### PRODUCT FEATURES:

1. Structural foam molded handles ensure strength and durability.
2. Nestable stacking, easy to clean, light weight.
3. Made from HDPE, which is recyclable and thus offers a low cost.
4. Materials comply with the requirements of domestic and foreign regulations on the international Food and Drug Sanitation regulations.



PNB1210

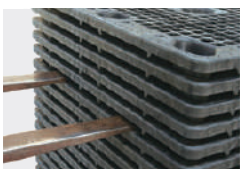

**Stacking coefficient (2.2),** to save storage space of the pallet



Designed for **easy entry of forklift** to save the time and make job simple



**Vents** are available on areas prone to water accumulation, so as to eliminate the possibility of water accumulation even when kept in open air

Model	Description	Dimensions	Fork high	Load (Static/Dynamic)	Color
PNB1111	Nestable Pallet	110.0 × 110.0 × 14.7cm	9.5cm	2500kg / 1000kg	BLA
PNB1208	Nestable Pallet	120.0 × 80.0 × 14.7cm	9.5cm	2000kg / 1000kg	BLA
PNB1210	Nestable Pallet	120.0 × 100.0 × 14.8cm	9.8cm	2500kg / 1000kg	BLA

## SHELF PALLETS

### PRODUCT FEATURES:

1. Structural foam molded handles ensure strength and durability.
2. Easy to clean, light weight.
3. Made from HDPE, which is recyclable and thus offers a low cost.
4. Integral double-sided plastic pallet structure suitable for stacking, shelving systems and cargo transportation.
5. Designed for cleanliness and improved sanitation helping to reduce cleaning frequency.
6. Pallet design is CAE optimized - lightweight with increased load capacity.



PRB1210

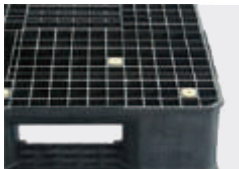

Designed for **easy forklift entry** to save time and reduce the possibility of damage



The **solid, extra-thick base ribs** are arranged to increase strength of pallet base, thus enhancing its shelving and stacking durability



The **grid structure** allows for easy and simple cleaning, and eliminates the problem of water accumulation even when stored in the open

Model	Description	Dimensions	Fork high	Load (Static/Dynamic)	Color
PRB1210	Shelf Pallets	120.0 × 100.0 × 16.7cm	94cm	13500kg / 2300kg	BLA

## STACKING PALLETS

### PRODUCT FEATURES:

1. Structural foam molded handles ensure strength and durability.
2. Easy to clean, light weight.
3. Made from HDPE, which is recyclable and thus offers a low cost.
4. Pallet design is CAE optimized - lightweight with increased load capacity. Patented leg design for easy servicing.
5. All-plastic structure and smooth surfaces reduce the possibility of damage to products.
6. Materials comply with the requirements of domestic and international Food and Drug Sanitation regulations.



PSB1210



**Patented detachable legs** can be easily replaced if the pallet is partially damaged



The round corner of the leg and the beveled angle of the top and base plates are designed for **easy operation of forklifts**



**Extra-large area base plate** ensures maximized contact area between the material and the plate to enhance stacking stability

Model	Description	Dimensions	Fork high	Load (Static/Dynamic)	Color
PSB1210	Stacking Pallet	120.0 × 100.0 × 14.9cm	7.6cm	4500kg / 1200kg	BLA

## HEAVY-LOAD BULK CONTAINERS

### PRODUCT FEATURES:

1. Structural foam molded construction ensures strength and durability.
2. Easy to clean, lightweight.
3. Provides reliable protection for contents when used in picking, assembling, processing, warehousing and logistics operations in a variety of industries.

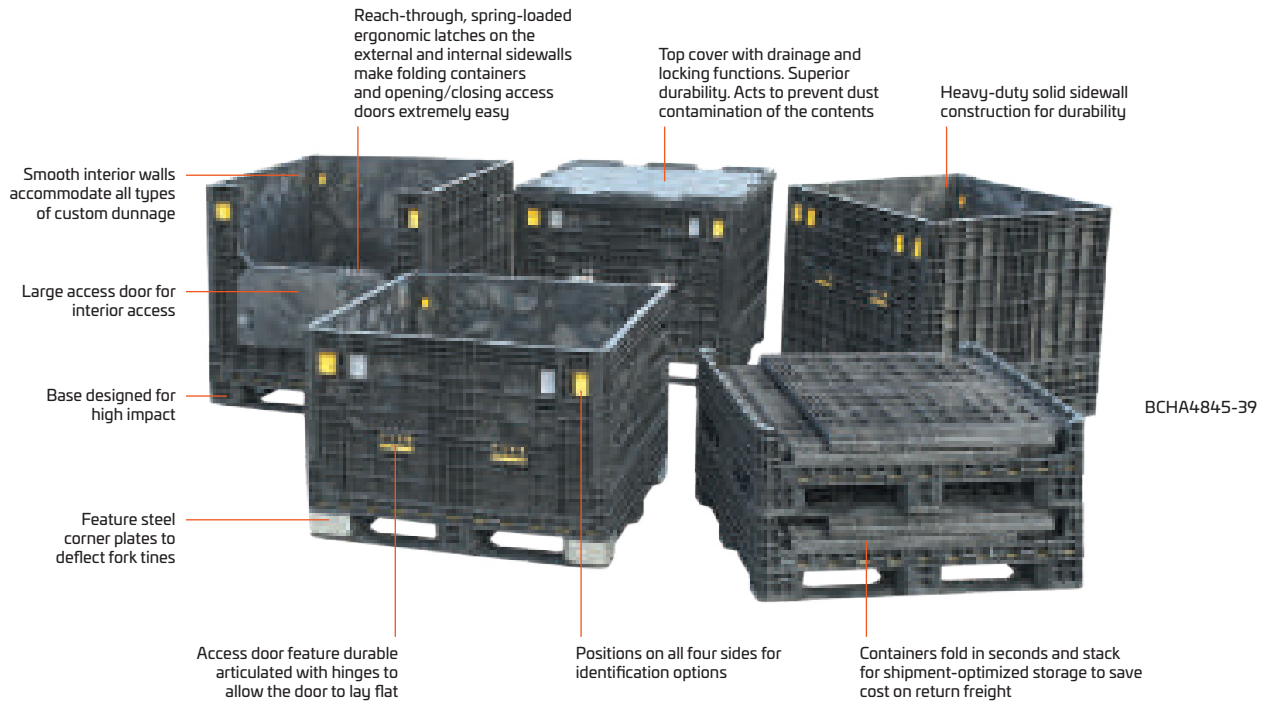

**Large size flip door** for easy loading and unloading of cargo



**Top cover with drainage and locking functions.** Superior durability. Acts to prevent dust contamination of the contents.



**Secure stackability** maximizes warehouse space without the use of racking



Bulk containers **can be folded** to save storage space and reduce transport cost

Model	Description	Container External Dimension	Container Internal Dimension	Load	Color
BCHA1210-09	Heavy-load Bulk Container	120.0 × 100.0 × 87.1cm	111.8 × 91.8 × 73.0cm	788kg	BLA
BCHA1210-10	Heavy-load Bulk Container	120.0 × 100.0 × 97.5cm	111.8 × 91.8 × 83.4cm	788kg	BLA
BCHA1210-11	Heavy-load Bulk Container	120.0 × 100.0 × 107.4cm	111.8 × 91.8 × 93.3cm	675kg	BLA
BCHA4845-25	Heavy-load Bulk Container	121.9 × 114.3 × 63.5cm	113.2 × 105.2 × 47.0cm	900kg	BLA
BCHA4845-34	Heavy-load Bulk Container	121.9 × 114.3 × 86.3cm	113.2 × 105.2 × 69.8cm	788kg	BLA
BCHA4845-39	Heavy-load Bulk Container	121.9 × 114.3 × 99.0cm	113.2 × 105.2 × 82.5cm	788kg	BLA
BCHA4845-42	Heavy-load Bulk Container	121.9 × 114.3 × 106.6cm	113.2 × 105.2 × 90.1cm	675kg	BLA
BCHA4845-46	Heavy-load Bulk Container	121.9 × 114.3 × 116.8cm	113.2 × 105.2 × 100.3cm	675kg	BLA
BC1210	Top	122.0 × 101.9 × 8.8cm	N/A	N/A	BLA
BC4845	Top	124.3 × 116.7 × 7.7cm	N/A	N/A	BLA





**FOOD STORAGE**

Food Material Storage Bins	184
Shelf-type Raw Food Material Containers	185
Goods Shelves	185
Thor® Food Storage Boxes	186
Thor® Stackable Food Storage Bins	186
Thor® Square Food Containers	187
Large Food Containers	187
Thor® Fresh Fruit and Vegetables Storage Bins with Lid and Cart	188
Thor® Ice Buckets	188
Food Pans	190
Cold Food Pans	190
Hot Food Pans	190
Cold Food Pans	196
Polycarbonate (PC) Cold Food Pans	196
Polypropylene (PP) Cold Food Pans	196
Round Storage Containers	200

Firmgre® Storage System	202
Firmgre® Starter Kits and Extensions	208
Firmgre® Mobile Storage Kits	210
Firmgre® Parts	211
Firmgre® Accessories	212
Firmgre® Modus Storage System	214
Firmgre® Modus Starter Kits and Extensions	214
Firmgre® Modus Accessories	216
Firmgre® Modus Parts	217

**INSULATED PRODUCTS**

Insulated Boxes	218
Insulated Bottles	219
Cold Drink Coolboxes	219
Excebox® Insulated Food Carriers	220
Front-Loading Excebox®	224
Top-Loading Excebox®	226

Excebox® Accessories	228
----------------------	-----

**TRANSPORT**

Food Storage Racks/Carts	230
Adjustable Tray & Dish Carts	231
Oeasy® Platform Trucks	232
Hi5® Utility Service Carts	232
Hi5® Folding Service Carts	233
Hi5® Utility Service Carts Accessories	234
Bitbar® Utility Carts	235
Bitbar® Flat-shelf Carts	236
Utility Trolleys	238
Glass Rack Trolleys	238
Catering Disks	239
GRP Non-slip Trays	239
PP Non-slip Trays	240
Wood Grain Non-slip Trays	240



**FOOD PREPARATION**

Scrapper	242
Chopping Boards	243

**DISHWASHING AND STORAGE**

Cupcomb® Warewashing System	244
Cupcomb® Full Size Glass Racks	245
Cupcomb® Half Size Glass Racks	247
Cupcomb® Base and Flatware Racks	248
Cupcomb® Peg Rack	249
Cupcomb® Tray Rack	249
Cupcomb® Flatware Basket	250
Cupcomb® Extender	250
Cupcomb® Accessories	251

**TOTE BOXES**

Tote Boxes	254
Cutlery Bins	254

Condiment Dispensers	255
Pitchers	255
Budget Pots	255

**YOUTH SERVICE**

Kid&Cool® Youth Seats	256
Heimdall® Baby Changing Stations	258
Kid&Cool® Infant Safety Seats	259

**CLEANING TOOLS**

Floor Sweeps	260
Counter Brushes	260
Multi-purpose Brushes	261
Cleaning Brushes	261
Chopping Board Cleaning Brushes	261
Angle Brooms	262
Vegetable Cleaning Brushes	262
Bottle Cleaning Brushes	262

Pipe Cleaning Brushes	263
High-temperature Cleaning Brushes	263
Coffee Machine Cleaning Brushes	263
Glass Brushes	264
Professional Plastic Squeegees	264
U-Rag® Superfine Fiber Cloths	265
Cleaning Tool Holders	265



## Improved Food Services

Our innovative products enhance food freshness, reduce costs, and improve service delivery.

## Sustainability Commitment

Exceptional product design, sound recyclability and durability, and the use of environmentally friendly materials are our commitment to environmental sustainability.

## Safety Commitment

Our products meet food preparation, storage and transport industry standards.





# HACCP



HAZARD



ANALYSIS



CRITICAL



CONTROL



POINTS

## What is HACCP

HACCP, which stands for Hazard Analysis Critical Control Points, is an internationally recognized method of identifying and managing food safety related risk. It is a management system in which food safety is addressed through the analysis and control of biological, chemical, and physical hazards from raw material production, procurement, and handling, to manufacturing, distribution and consumption of the finished product.

There are seven key principles in food safety:

- Hazard Analysis
- Critical Control Points
- Critical Limits
- Critical Control Monitoring
- Corrective Action
- Procedures
- Record Keeping

The seven HACCP principles are included in the international standard ISO 22000 FSMS 2005 and are implemented in many Food Safety Programs all around the world.

As a leading supplier to the food service industry, our products contribute to HACCP certification. We offer a full range of solutions from material handling to ingredient storage, cooking, transporting, waste management and cleaning to help you maintain food safety in your daily workflow.



### Material Handling

Trust utility carts and platform trucks allow for fast and efficient handling, which ensures food quality and reduces waste.



### Food Storage

Use our storage bins and containers to ensure that ingredients are dry, safe and free from external contamination.



### Cooking

Food pans make it easier to distribute food and measure portions accurately.



### Food Transporting

Our insulated boxes maintain their contents at a constant temperature during transport, ensuring food quality.



### Waste Management

Foot-operated pedal waste bins to avoid hand contact with contaminants and prevent cross-contamination.



### Cleaning

Microfiber cleaning tools for efficient and fast cleaning and disinfection.



## FOOD MATERIAL STORAGE BINS



### PRODUCT FEATURES:

1. Designed with a connected lid and a separate spoon to enable access to food materials with only one hand, for higher work efficiency.
2. Designed with a transparent lid to quickly identify the type of the contents and allows for easy inventory management.
3. Smooth walls assist easy cleaning without leaving behind any dirt.
4. All-plastic web structure ensures strength and durability.
5. The lid is easy to open for higher work efficiency.
6. Complies with NSF standards.



8411



8412



8414

Model	Description	Dimensions	Capacity	Color	Pack
8411	Food Material Storage Bin	74.3 × 33.4 × 75.5cm	80L	WHT	1
8412	Food Material Storage Bin	74.3 × 39.4 × 75.5cm	100L	WHT	1
8413	Food Material Storage Bin	74.3 × 45.7 × 75.5cm	120L	WHT	1
8414	Spoon	27.4 × 12.2 × 12.0cm	1L	CLR	6

### STORAGE BIN LID

8415	Storage Bin Lid - Fits 8411	73.7 × 30.7 × 4.8cm	N/A	WHT	1
8416	Storage Bin Lid - Fits 8412	73.7 × 36.8 × 4.8cm	N/A	WHT	1
8417	Storage Bin Lid - Fits 8413	73.7 × 43.7 × 4.8cm	N/A	WHT	1



## SHELF-TYPE RAW FOOD MATERIAL CONTAINERS



### PRODUCT FEATURES:

1. A space-saving shelf storage system that provides easy access to raw food materials when stacked.
2. Specially designed sliding lid and spoon allow access to raw materials with one hand, improving work efficiency.
3. Transparent lid for quick raw materials identification and inventory management.
4. "First in, first out" design to ensure food circulation and food quality.
5. Smooth inner wall for easy cleaning without leaving any dirt.
6. Durable plastic mesh structure.
7. The lid is easy to open, improving work efficiency.
8. Complies with NSF standards.



A storage system that can still allow you to **obtain raw food materials when stacked**, providing space utilization



Model	Description	Dimensions	Capacity	Color	Pack
8418	Shelf-type Raw Food Material Containers	38.1 × 29.8 × 21.6cm	10L	WHT	1
8419	Shelf-type Raw Food Material Containers	59.7 × 29.2 × 42.9cm	23L	WHT	1
8420	Shelf-type Raw Food Material Containers	59.7 × 48.8 × 42.9cm	47L	WHT	1

### SPOON

8433	0.5-Cup Measuring Spoon for 8418	18.7 × 8.6 × 3.8cm	0.12L	CLR	12
8434	2-Cup Measuring Spoon for 8419, 8420	11.7 × 13.0 × 13.3cm	0.48L	CLR	6

## GOODS SHELVES



### PRODUCT FEATURES:

1. Designed for storage of frozen, refrigerated or dry goods.
2. Structural foam molding ensures strength and durability.
3. The hollow pad offers maximized ventilation for perishable or dry goods.
4. The pad height meets NSF standards.
5. 4491 and 4493 Lock catches can lock shelves together for better stability.

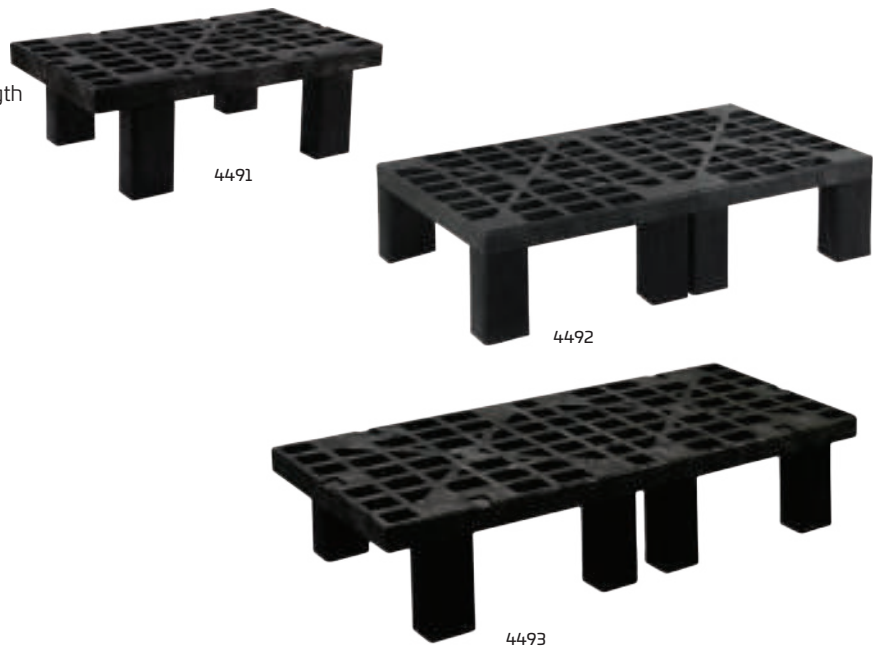

Lock catches can lock goods shelves together for better stability

Model	Description	Dimensions	Load	Color	Pack
4491	Goods Shelf	91.0 × 53.3 × 30.5cm	680kg	BLA	1
4492	Goods Shelf	122.0 × 61.0 × 30.5cm	900kg	BLA	1
4493	Goods Shelf	152.0 × 53.3 × 30.5cm	1360kg	BLA	1

## THOR® FOOD STORAGE BOXES



### PRODUCT FEATURES:

1. A must-to-have container for storage and moving.
2. Ribs on the bottom prevents damage when dragged.
3. Ergonomic handles offer a comfortable grip and help prevent hand injuries.
4. Comes with a tight lid. An ideal choice for the storage of food.
5. Complies with European food safety standards and NSF standards.
6. Combine with dollies to carry heavy loads quickly and conveniently.



Model	Description	Dimensions	Capacity	Color	Pack
3011	Food Storage Box with Lid	70.8 × 43.4 × 27.2cm	53L	BLUE, GRAY, GRN, RED, YEL, WHT, CLR	6
3012	Food Storage Box with Lid	70.8 × 43.4 × 38.4cm	75L	BLUE, GRAY, GRN, RED, YEL, WHT, CLR	6
4483	Totes Trolley	63.0 × 43.5 × 18.5cm	N/A	BLA	1

## THOR® STACKABLE FOOD STORAGE BINS



### PRODUCT FEATURES:

1. For cost-effective storage and transportation.
2. Fits 120 × 100cm pallets with no overhang.
3. Nestable for efficient storage and transport.
4. Stackable with and without lids.
5. All-plastic construction will not rust, dent, chip, or peel.
6. Rounded corners and smooth surfaces are easy to clean.
7. Complies with the requirements of NSF #2.



Staggered stackable

Model	Description	Dimensions	Capacity	Color	Pack
3021	Stackable Food Storage Bin	59.2 × 39.2 × 27.0cm	40L	BLUE, GRN, RED, YEL, WHT	6
3022	Stackable Food Storage Bin	59.2 × 39.2 × 36.0cm	55L	BLUE, GRN, RED, YEL, WHT	6
3023	Lid for 3021/3022	60.0 × 40.0 × 3.3cm	N/A	BLUE, GRN, RED, YEL, WHT	6

## THOR® SQUARE FOOD CONTAINERS



### PRODUCT FEATURES:

1. Square shape offers up to 27% more capacity than round containers.
2. Designed with an ergonomic handle for a smooth and comfortable grip.
3. Reinforced rims add strength and durability.
4. Thick walls up to 4 mm add strength and durability.
5. Bottom hand grips of 30 mm width assist in emptying.
6. Tight fitting lids help protect the contents.
7. Square dollies are available to ensure easy mobility and maneuverability of heavy loads.



Model	Description	Dimensions	Capacity	Color	Pack
1231	THOR® Square Food Container	54.6 × 54.6 × 57.2cm	100L	WHT	6
1233	THOR® Square Food Container	59.7 × 59.7 × 73.0cm	150L	WHT	4
1812	THOR® Square Dolly for 1231/1233	43.8 × 15.9cm	N/A	BLA	2
TOPS					
1661	THOR® Lid for 1231	55.9 × 55.9 × 5.1cm	N/A	WHT	6
1663	THOR® Lid for 1233	61.0 × 61.0 × 5.1cm	N/A	WHT	4

## LARGE FOOD CONTAINERS



### PRODUCT FEATURES:

1. Suitable for delivering and storing raw food materials.
2. Rotomolded, industrial-grade strength, transports heavy loads with ease.
3. Metal frame provides durable support.



Model	Description	Dimensions	Load	Color	Pack
4710	0.2 m <sup>3</sup> Large Food Box	98.0 × 72.0 × 76.0cm	135kg	WHT	2
4711	0.3 m <sup>3</sup> Large Food Box	114.5 × 75.0 × 88.0cm	180kg	WHT	2
4714	0.4 m <sup>3</sup> Large Food Box	117.0 × 84.0 × 86.0cm	230kg	WHT	2
4715	0.5 m <sup>3</sup> Large Food Box	125.5 × 92.0 × 94.0cm	230kg	WHT	2

## THOR® FRESH FRUITS AND VEGETABLES STORAGE BINS WITH LID AND CART



### PRODUCT FEATURES:

1. An ideal solution for storage, washing, drying and to maintain the flavor of fresh fruits and vegetables.
2. Designed with an in-built tank to collect water flowing through the filter disc.
3. Equipped with a handy detachable cart for easily transporting the bin from an unloading area to the cleaning or cold storage areas.
4. Accompanied with a tightly-fit lid to keep fruits and vegetables fresh and clean.
5. Seamless construction and smooth interior walls ensure easy cleaning.
6. For storage of oranges, strawberries, tomatoes and other fruits and vegetables.



Model	Description	Dimensions	Capacity	Color	Pack
8421	Fresh Fruits and Vegetables Storage Bin with a Lid and a Cart Storage Box with Lid	57.2 × 85.1cm	75L	WHT	1
8422	Fresh Fruits and Vegetables Storage Bin with a Lid and a Cart Storage Box with Lid	63.5 × 97.8cm	121L	WHT	1

## THOR® ICE BUCKETS



### PRODUCT FEATURES:

1. Ensures safe delivery of ice.
2. All-plastic construction will not rust, chip, or peel; resists dents.
3. Comes with an ergonomic rounded handle providing a comfortable grip.
4. Reinforced rim adds to strength and durability.
5. Bottom hand-grips of 30 mm width assist in emptying.
6. Bucket surface is printed with the name of the contents for easy recognition.
7. Complies with NSF #2 inspection standards.



Model	Description	Dimensions	Capacity	Color	Pack
8431	Ice Bucket	40.0 × 44.0cm	38L	WHT	6
8432	Ice Bucket	49.0 × 57.0cm	75L	WHT	6





## FOOD PANS



### PRODUCT FEATURES:

1. Makes preparing, cooking, serving and storing effortless.
2. No Bisphenol A, effectively preventing food safety risks.
3. Resistant to rust, dent, twist, odor and cross contamination.
4. Materials are inert reducing the potential for chemical or acid reactions.
5. Effectively prevent cross-contamination.
6. Non-stick feature makes cleaning easier.
7. Complies with the standards of EN 631-1.
8. Complies with the requirements of NSF #2.

## COLD FOOD PANS

### PRODUCT FEATURES:

1. Lessens the work load and operating costs for preparation, freezing, baking and steaming.
2. Temperature rated: -40°C to 100°C.
3. Steam table and microwave safe, not for use with an open flame.
4. Not as cool to touch as metal.

## HOT FOOD PANS

### PRODUCT FEATURES:

1. Lessens the work load and costs of operation over preparation, freezing, baking and steaming.
2. Temperature rated: -40°C to 190°C.
3. Steam table well and microwave safe, not for use open flame.
4. Cooler to the touch than metal.



Tritan™ is a new generation of copolyester from the Eastman company having passed FDA certification.

1. Eastman Tritan does not contain Bisphenol A (BPA). BPA is not and has never been an ingredient or by-product of the production of Eastman Tritan™.
2. Eastman Tritan is transparent with a crystalline luster, light transmittance is greater than 90%, while haze is less than 1%.
3. Eastman Tritan is a tough and durable material that can maintain functional and aesthetic integrity over a long product life. Eastman Tritan compares favorably with PC in notched Izod impact tests. At 1/4" thickness, PC demonstrates low energy absorption and brittle failure, while Eastman Tritan continues to demonstrate high energy absorption (exceeding 15 ft-lb/in.) and ductile behavior.
4. Eastman Tritan has a higher glass transition temperature (Tg) than traditional copolyesters, which can provide a greater ability to withstand higher temperatures in dishwashers and other environments.

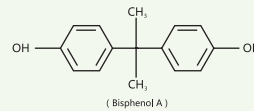

Bisphenol A (BPA), is used to synthesise PC and epoxy resin in industry.

BPA is an environmental health concern due to its widespread exposure as well as its potential toxicity. BPA is an endocrine disruptor which acts as an estrogen mimic. Evidence suggests that BPA affects circulating hormone levels, cardiovascular health, obesity, reproductive health in both males and females, hormone-driven cancers and neurobehavioral development in children. <sup>(1)</sup>

On Oct 18, 2008 Canada announced that bisphenol A is toxic chemical and became the first country in the world to rank it as such and prohibit from use PC food containers which contain bisphenol A. Norway, the United States, Sweden and other European and American developed countries also gradually began to ban the use of BPA in food containers.

(1) Ellen M. Wells, in Encyclopedia of Environmental Health (Second Edition), 2019

## Food Pan Construction



## Food Pan Layout

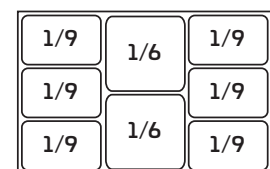
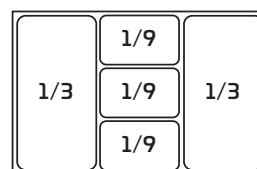
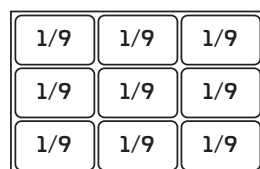
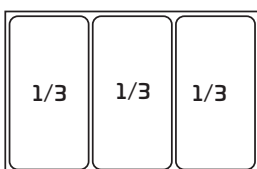
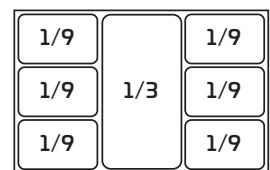
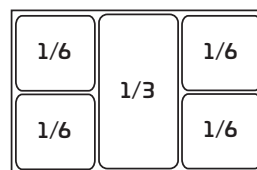
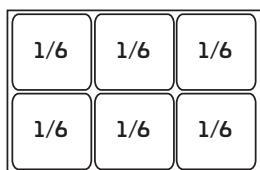
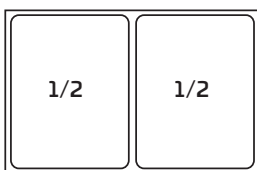
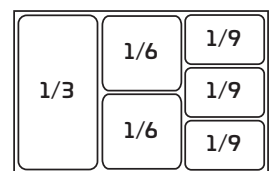
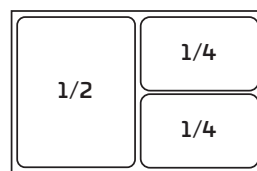
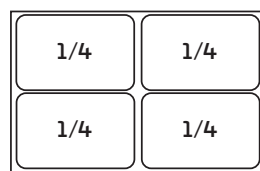
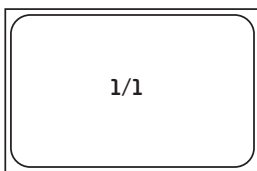

## GN 1/1 FOOD PAN

Size	Depth	Capacity	Cold Food Pan		Hot Food Pan		Case Pack
			Model	Color	Model	Color	
530 × 325mm	65 mm	8.5L	8451	CLR	8811	AMBER, BLA	6
	100 mm	13.0L	8452	CLR	8812	AMBER, BLA	6
	150 mm	19.5L	8453	CLR	8813	AMBER, BLA	6
	200 mm	25.7L	8454	CLR			6

## GN 1/2 FOOD PAN

Size	Depth	Capacity	Cold Food Pan		Hot Food Pan		Case Pack
			Model	Color	Model	Color	
325 × 265mm	65 mm	3.8L	8461	CLR	8821	AMBER, BLA	6
	100 mm	6.0L	8462	CLR	8822	AMBER, BLA	6
	150 mm	8.8L	8463	CLR	8823	AMBER, BLA	6
	200 mm	10.8L	8464	CLR			6

## GN 1/3 FOOD PAN

Size	Depth	Capacity	Cold Food Pan		Hot Food Pan		Case Pack
			Model	Color	Model	Color	
325 × 176mm	65 mm	2.5L	8471	CLR	8831	AMBER, BLA	6
	100 mm	3.8L	8472	CLR	8832	AMBER, BLA	6
	150 mm	5.1L	8473	CLR	8833	AMBER, BLA	6
	200 mm	7.0L	8474	CLR			6

## GN 1/4 FOOD PAN

Size	Depth	Capacity	Cold Food Pan		Hot Food Pan		Case Pack
			Model	Color	Model	Color	
265 × 162mm	65 mm	1.6L	8481	CLR	8841	AMBER, BLA	6
	100 mm	2.4L	8482	CLR	8842	AMBER, BLA	6
	150 mm	3.8L	8483	CLR	8843	AMBER, BLA	6

## GN 1/6 FOOD PAN

Size	Depth	Capacity	Cold Food Pan		Hot Food Pan		Case Pack
			Model	Color	Model	Color	
176 × 162mm	65 mm	1.1L	8491	CLR	8851	AMBER, BLA	6
	100 mm	1.6L	8492	CLR	8852	AMBER, BLA	6
	150 mm	2.4L	8493	CLR	8853	AMBER, BLA	6

## GN 1/9 FOOD PAN

Size	Depth	Capacity	Cold Food Pan		Hot Food Pan		Case Pack
			Model	Color	Model	Color	
176 × 108mm	65 mm	0.6L	8497	CLR	8861	AMBER, BLA	6
	100 mm	0.8L	8498	CLR	8862	AMBER, BLA	6

## LIDS WITH HANDLE



### PRODUCT FEATURES:

1. Molded stable handles.
2. No Bisphenol A, effectively preventing food safety risks.
3. Resistant to rust, dents and twisting.
4. Cold food pan cover temperature rated: -40°C to 100°C.
5. Hot food pan cover temperature rated: -40°C to 190°C.
6. Complies with EN 631-1 standards.
7. Complies with the requirements of NSF #2.

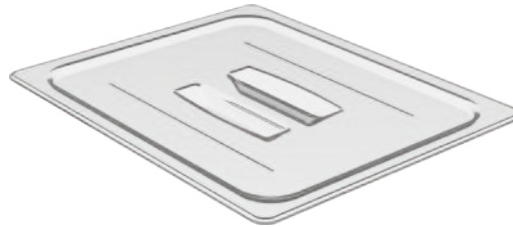

8465

Fits Pan	Cold Food Pan Cover		Hot Food Pan Cover		Case Pack
	Model	Color	Model	Color	
<b>GN1/1</b> 530 × 325 mm	8455	CLR	8814	AMBER	6
<b>GN1/2</b> 325 × 265 mm	8465	CLR	8824	AMBER	6
<b>GN1/3</b> 325 × 176 mm	8475	CLR	8834	AMBER	6
<b>GN1/4</b> 265 × 162 mm	8484	CLR	8844	AMBER	6
<b>GN1/6</b> 176 × 162 mm	8494	CLR	8854	AMBER	6

## LIDS WITH OPENING AND HANDLE



### PRODUCT FEATURES:

1. Molded stable handles.
2. No Bisphenol A, effectively preventing food safety risks.
3. Resistant to rust, dents and twisting.
4. Opening for kitchen utensils for a cleaner more organised kitchen.
5. Cold food pan cover temperature rated: -40°C to 100°C.
6. Hot food pan cover temperature rated: -40°C to 190°C.
7. Complies with EN 631-1 standards.
8. Complies with the requirements of NSF #2.



8466

Fits Pan	Cold Food Pan Cover		Hot Food Pan Cover		Case Pack
	Model	Color	Model	Color	
<b>GN1/1</b> 530 × 325 mm	8456	CLR	8815	AMBER	6
<b>GN1/2</b> 325 × 265 mm	8466	CLR	8825	AMBER	6
<b>GN1/3</b> 325 × 176 mm	8476	CLR	8835	AMBER	6
<b>GN1/4</b> 265 × 162 mm	8485	CLR	8845	AMBER	6
<b>GN1/6</b> 176 × 162 mm	8495	CLR	8855	AMBER	6

## FLAT LIDS



### PRODUCT FEATURES:

1. Fits any plate size.
2. No Bisphenol A, effectively preventing food safety risks.
3. Resistant to rust, dents and twisting.
4. Cold food pan cover temperature rated: -40°C to 100°C.
5. Hot food pan cover temperature rated: -40°C to 190°C.
6. Complies with EN 631-1 standards.
7. Complies with the requirements of NSF #2.



8467

Fits Pan	Cold Food Pan Cover		Hot Food Pan Cover		Case Pack
	Model	Color	Model	Color	
<b>GNI/1</b> 530 × 325 mm	8457	CLR	8816	AMBER	6
<b>GNI/2</b> 325 × 265 mm	8467	CLR	8826	AMBER	6
<b>GNI/3</b> 325 × 176 mm	8477	CLR	8836	AMBER	6
<b>GNI/4</b> 265 × 162 mm	8486	CLR	8846	AMBER	6
<b>GNI/6</b> 176 × 162 mm	8496	CLR	8856	AMBER	6
<b>GNI/9</b> 176 × 108 mm	8499	CLR	8863	AMBER	6

## DRAIN TRAYS



### PRODUCT FEATURES:

1. Suitable for the preparation of vegetables, frozen seafood, meat thawing and storage.
2. No Bisphenol A, effectively preventing food safety risks.
3. Resistant to rust, dents and twisting.
4. Cold drain tray temperature rated: -40°C to 100°C.
5. Hot drain tray cover temperature rated: -40°C to 190°C.
6. Complies with the requirements of NSF #2.

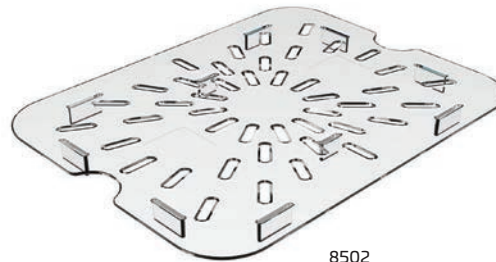

8502

Fits Pan	Cold Drain Tray		Hot Drain Tray		Case Pack
	Model	Color	Model	Color	
<b>GNI/1</b> 530 × 325 mm	8501	CLR	8506	AMBER	6
<b>GNI/2</b> 325 × 265 mm	8502	CLR	8507	AMBER	6
<b>GNI/3</b> 325 × 176 mm	8503	CLR	8508	AMBER	6
<b>GNI/4</b> 265 × 162 mm	8504	CLR	8509	AMBER	6
<b>GNI/6</b> 176 × 162 mm	8505	CLR	8510	AMBER	6





## COLD FOOD PANS

### PRODUCT FEATURES:

1. Makes food preparation, cooking, serving and storing effortless.
2. Break resistant, won't rust, dent or twist.
3. Reduces potential of chemical or acid reactions and resulting food contaminations.
4. Effectively avoids cross-contamination.
5. Dishwasher and microwave safe.
6. Quieter, not as cool to touch and with less condensation than metal.
7. Non-stick surfaces for easy food debris removal and cleaning.
8. Complies with EN 631-1 standards.
9. Comply with the requirements of NSF #2.



### POLYCARBONATE (PC) COLD FOOD PANS

#### PRODUCT FEATURES:

1. Significantly less cost than stainless steel.
2. Crystal clear.
3. Temperature rated: -40°C to 99.8°C.



### POLYPROPYLENE (PP) COLD FOOD PANS

#### PRODUCT FEATURES:

1. The most economical option.
2. Semi-transparent, allows contents to be visible.
3. Temperature rated: -40°C to 70°C.
4. BPA free.



PC

PP

## GN 1/1 FOOD PAN

Size	Depth	Capacity	PC Cold Food Pan		PP Cold Food Pan		Case Pack
			Model	Color	Model	Color	
530 × 325mm	65 mm	8.5L	8911	CLR	8731	CLR	6
	100 mm	13.0L	8912	CLR	8732	CLR	6
	150 mm	19.5L	8913	CLR	8733	CLR	6
	200 mm	25.7L	8914	CLR	8734	CLR	6

## GN 1/2 FOOD PAN

Size	Depth	Capacity	PC Cold Food Pan		PP Cold Food Pan		Case Pack
			Model	Color	Model	Color	
325 × 265mm	65 mm	3.8L	8921	CLR	8741	CLR	6
	100 mm	6.0L	8922	CLR	8742	CLR	6
	150 mm	8.8L	8923	CLR	8743	CLR	6
	200 mm	10.8L	8924	CLR	8744	CLR	6

## GN 1/3 FOOD PAN

Size	Depth	Capacity	PC Cold Food Pan		PP Cold Food Pan		Case Pack
			Model	Color	Model	Color	
325 × 176mm	65 mm	2.5L	8931	CLR	8751	CLR	6
	100 mm	3.8L	8932	CLR	8752	CLR	6
	150 mm	5.1L	8933	CLR	8753	CLR	6
	200 mm	7.0L	8934	CLR	8754	CLR	6

## GN 1/4 FOOD PAN

Size	Depth	Capacity	PC Cold Food Pan		PP Cold Food Pan		Case Pack
			Model	Color	Model	Color	
265 × 162mm	65 mm	1.6L	8941	CLR	8761	CLR	6
	100 mm	2.4L	8942	CLR	8762	CLR	6
	150 mm	3.8L	8943	CLR	8763	CLR	6

## GN 1/6 FOOD PAN

Size	Depth	Capacity	PC Cold Food Pan		PP Cold Food Pan		Case Pack
			Model	Color	Model	Color	
176 × 162mm	65 mm	1.1L	8951	CLR	8771	CLR	6
	100 mm	1.6L	8952	CLR	8772	CLR	6
	150 mm	2.4L	8953	CLR	8773	CLR	6

## GN 1/9 FOOD PAN

Size	Depth	Capacity	PC Cold Food Pan		PP Cold Food Pan		Case Pack
			Model	Color	Model	Color	
176 × 108mm	65 mm	0.6L	8961	CLR	8781	CLR	6
	100 mm	0.8L	8962	CLR	8782	CLR	6

## LIDS WITH HANDLE



### PRODUCT FEATURES:

1. Molded construction handles are stable.
2. PP cold food pan cover does not contain Bisphenol A(BPA), which effectively prevents food safety risks.
3. Resistant to rust, dent and twist.
4. Cold food pan cover temperature rated: -40°C to 99.8°C.
5. Complies with the standards of EN 631-1.
6. Complies with the requirements of NSF #2.

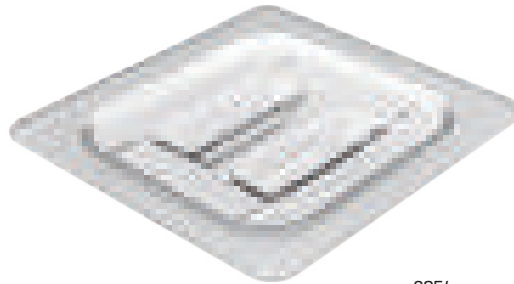

8954

Fits Pan	PC Cold Food Pan Cover		PP Cold Food Pan Cover		Case Pack
	Model	Color	Model	Color	
<b>GNI/1</b> 530 × 325 mm	8915	CLR	8735	CLR	6
<b>GNI/2</b> 325 × 265 mm	8925	CLR	8745	CLR	6
<b>GNI/3</b> 325 × 176 mm	8935	CLR	8755	CLR	6
<b>GNI/4</b> 265 × 162 mm	8944	CLR	8764	CLR	6
<b>GNI/6</b> 176 × 162 mm	8954	CLR	8774	CLR	6

## LIDS WITH ENTRY AND HANDLE



### PRODUCT FEATURES:

1. Molded construction handles are stable.
2. PP cold food pan cover does not contain Bisphenol A(BPA), which effectively prevents food safety risks.
3. Resistant to rust, dent and twist.
4. Gaps design allows the kitchen utensils in the food dish and make sure the kitchen clean.
5. Cold food pan cover temperature rated: -40°C to 99.8°C.
6. Complies with the standards of EN 631-1.
7. Complies with the requirements of NSF #2.

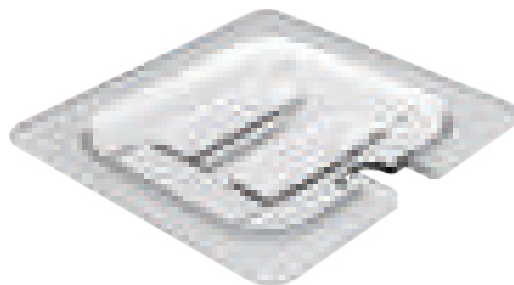

8955

Fits Pan	PC Cold Food Pan Cover		PP Cold Food Pan Cover		Case Pack
	Model	Color	Model	Color	
<b>GNI/1</b> 530 × 325 mm	8916	CLR	8736	CLR	6
<b>GNI/2</b> 325 × 265 mm	8926	CLR	8746	CLR	6
<b>GNI/3</b> 325 × 176 mm	8936	CLR	8756	CLR	6
<b>GNI/4</b> 265 × 162 mm	8945	CLR	8765	CLR	6
<b>GNI/6</b> 176 × 162 mm	8955	CLR	8775	CLR	6

## FLAT LID



### PRODUCT FEATURES:

1. Fits any plate size.
2. PP cold food pan cover does not contain Bisphenol A(BPA), which effectively prevents food safety risks.
3. Resistant to rust, dent and twist.
4. Cold food pan cover temperature rated: -40°C to 99.8°C.
5. Complies with the standards of EN 631-1.
6. Complies with the requirements of NSF #2.

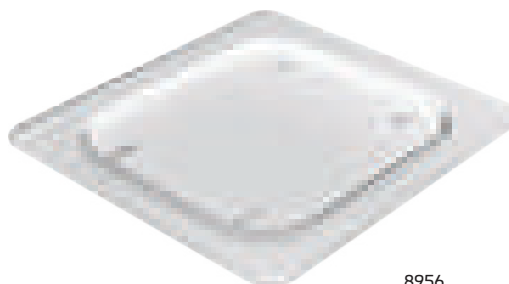

8956

Fits Pan	PC Cold Food Pan Cover		PP Cold Food Pan Cover		Case Pack
	Model	Color	Model	Color	
<b>GN1/1</b> 530 × 325 mm	8917	CLR	8737	CLR	6
<b>GN1/2</b> 325 × 265 mm	8927	CLR	8747	CLR	6
<b>GN1/3</b> 325 × 176 mm	8937	CLR	8757	CLR	6
<b>GN1/4</b> 265 × 162 mm	8946	CLR	8766	CLR	6
<b>GN1/6</b> 176 × 162 mm	8956	CLR	8776	CLR	6
<b>GN1/9</b> 176 × 108 mm	8963	CLR	8783	CLR	6

## DRAIN TRAYS



### PRODUCT FEATURES:

1. Suitable for the preparation of vegetables, frozen seafood, meat thawing and storage.
2. PP cold drain tray does not contain Bisphenol A(BPA), which effectively prevents food safety risks.
3. Resistant to rust, dent and twist.
4. Cold drain tray temperature rated: -40°C to 99.8°C.
5. Complies with the requirements of NSF #2.



8975

Fits Pan	PC Cold Drain Tray		PP Cold Drain Tray		Case Pack
	Model	Color	Model	Color	
<b>GN1/1</b> 530 × 325 mm	8971	CLR	8791	CLR	6
<b>GN1/2</b> 325 × 265 mm	8972	CLR	8792	CLR	6
<b>GN1/3</b> 325 × 176 mm	8973	CLR	8793	CLR	6
<b>GN1/4</b> 265 × 162 mm	8974	CLR	8794	CLR	6
<b>GN1/6</b> 176 × 162 mm	8975	CLR	8795	CLR	6

## ROUND STORAGE CONTAINERS



### PRODUCT FEATURES:

1. Stores food safely and conveniently.
2. Two models available with white polyethylene or semi-clear polypropylene, for better visibility.
3. Easy-to-clean cover.
4. Suitable for temperatures between -34°C and 100°C.
5. Compiles with the requirements of NSF 3A and NSF 2.



**Semi-clear Polypropylene Round Storage Containers**

Model	Description	Dimensions	Capacity	Color	Pack
8311	Round Storage Container	21.6 × 10.2cm	1.9L	STRAN	12
8312	Round Storage Container	21.6 × 19.7cm	3.8L	STRAN	12
8313	Round Storage Container	25.4 × 19.4cm	5.7L	STRAN	12
8314	Round Storage Container	25.4 × 27.0cm	7.6L	STRAN	12
8315	Round Storage Container	33.3 × 20.6cm	11.4L	STRAN	6
8316	Round Storage Container	33.3 × 30.2cm	17.0L	STRAN	6
8317	Round Storage Container	33.3 × 35.6cm	20.8L	STRAN	6
8318	Round Storage Container with Bail	33.3 × 35.6cm	20.8L	STRAN	6



**Polyethylene Round Storage Containers**

Model	Description	Dimensions	Capacity	Color	Pack
8321	Round Storage Container	21.6 × 10.2cm	1.9L	WHT	12
8322	Round Storage Container	21.6 × 19.7cm	3.8L	WHT	12
8323	Round Storage Container	25.4 × 19.4cm	5.7L	WHT	12
8324	Round Storage Container	25.4 × 27.0cm	7.6L	WHT	12
8325	Round Storage Container	33.3 × 20.6cm	11.4L	WHT	6
8326	Round Storage Container	33.3 × 30.2cm	17.0L	WHT	6
8327	Round Storage Container	33.3 × 35.6cm	20.8L	WHT	6
8328	Round Storage Container with Bail	33.3 × 35.6cm	20.8L	WHT	6

## LIDS



### PRODUCT FEATURES:

1. Double wall insulated lock is easy to use and keeps food fresh.
2. Unique way to hold, easy and stable.
3. Taggable with customized notes.
4. Three sizes available to fit up to 8 different kinds of containers.

Specially designed lid is convenient to open



Model	Description	Dimensions	Capacity	Color	Pack
8331	Lid for 8311, 8312, 8321, 8322	22.2 × 2.2cm	N/A	YEL	12
8332	Lid for 8313, 8314, 8323, 8324	26.0 × 2.5cm	N/A	YEL, NAT	12
8333	Lid for 8315, 8316, 8317, 8318, 8325, 8326, 8327, 8328	34.0 × 3.0cm	N/A	YEL, NAT	6



## FIRMGRE STORAGE SYSTEM



Trust offers two shelving storage systems for the hospitality industry comprising the Firmgre® and Firmgre® Modus storage systems. No matter your space or budget, we have a perfect solution for you! By choosing our storage system, you can achieve maximum cost savings, efficient use of space and meet hygiene, food safety and functionality standards.

1. Made from materials that are rust and corrosion-free.
2. Suitable for all kinds of environments, and can be used at temperatures between -40°C and 90°C.
3. Impervious to water, chemicals, salts, acid, alkali and humidity.
4. Maximizes storage space with shelves that are designed to share posts without losing overall load capacity.
5. Specially designed internal slots on the posts create a neat appearance and make the posts safer to hold.
6. Cleaning can be completed quickly without affecting storage capacity and utility.
7. Each shelf can be easily and individually adjusted to accommodate different items.



## FIRMGR® CONFIGURATIONS

### STARTER KIT

Complete set to build one 4-shelf unit:

2 Post Kits 4 Shelf Kits

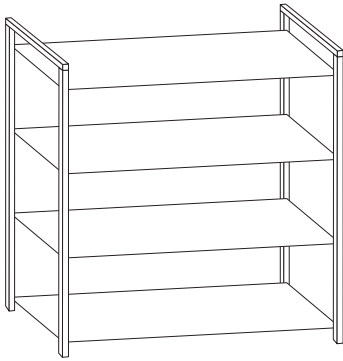

### EXTENSION KIT

Extension set to add to 4-shelf units:

1 Post Kit 4 Shelf Kits

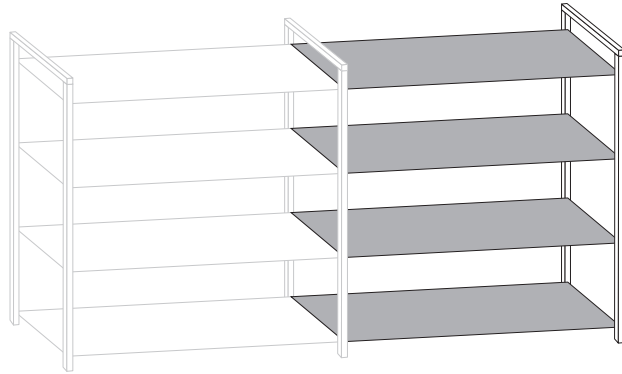

### CORNER UNIT

(STARTER KIT + EXTENSION)

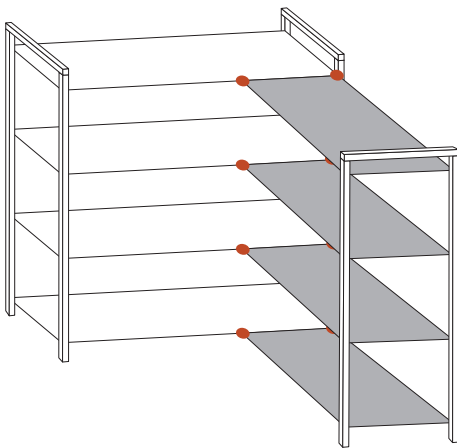

### U-SHAPE UNIT

(2 STARTER KITS + 4 SHELF KITS)

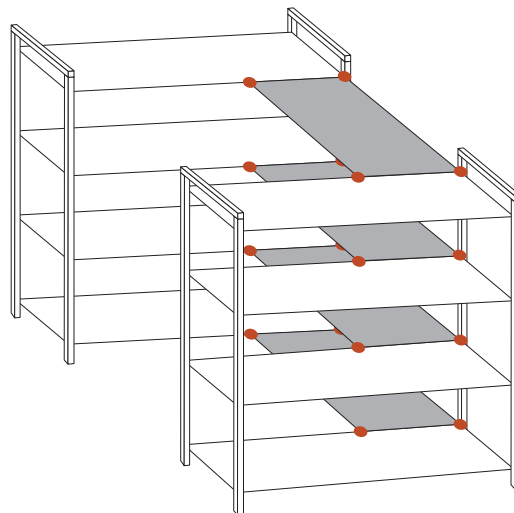

### T-SHAPE UNIT

(STARTER KIT + EXTENSION)

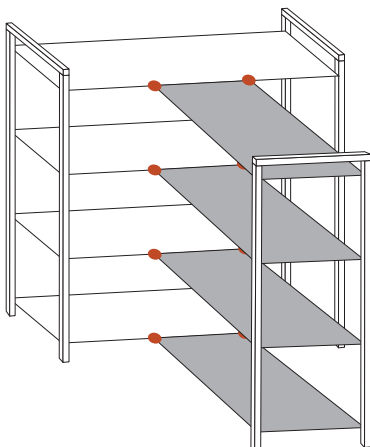

#### ● CORNER CONNECTORS

Connect the shelves with Corner Connectors to turn difficult areas into more accessible storage spaces.

## FIRMGRE® SYSTEM COMPARISON

	FIRMGRE® SYSTEM	FIRMGRE® MODUS SYSTEM
<b>STORAGE AREA</b>	Regular loading and unloading of medium to heavy products for high volume food service operations. 5-7 deliveries per week <b>Wet storage</b> small freezer, cooler, warewashing area <b>Dry storage</b> bulk food, food service equipment, tableware/cutlery, linen products, goods	Regular loading and unloading of light to medium products for medium volume food service operations. 3-4 deliveries per week. <b>Wet storage</b> small freezer, cooler, warewashing area <b>Dry storage</b> bulk food, food service equipment, tableware/cutlery, linen products, goods
<b>RECOMMENDED MARKET SEGMENTS</b>	Hotels and entertainment venues, restaurants, fast food outlets, schools, colleges and universities, medical institutions, military institutions, convention centers, cruise ships, catering venues, corporate cafeteria, convenience stores and grocery stores	Hotels and entertainment venues, restaurants, fast food outlets, schools, colleges and universities, medical institutions, convention centers, catering venues, corporate cafeteria, convenience stores and cafes
<b>LOAD CAPACITY (Please refer to the diagrams on the next page for detail)</b>	<b>Fixed shelf</b> (Based on 610-1220mm length) 350kg load capacity per partition. Each shelf has a load capacity of 1400kg. <b>Mobile shelves</b> each shelf has a load capacity of 340kg. <b>Corner, U-shaped and T-shaped shelves</b> (Based on 610-1220mm length) 180kg on the 3 top partitions, 275kg on the bottom partition, 815kg per shelf.	<b>Fixed shelf</b> (Based on 760-910mm length) 300kg load capacity per partition. Each shelf has a load capacity of 1200kg. <b>Corner, U-shaped and T-shaped shelves</b> (Based on 760-1220mm length) 135kg on the 3 top partitions, 205kg on the bottom partition, 610kg per shelf.
<b>SHELF LENGTH</b>	610, 760, 910, 1070, 1220, 1380, 1530, 1830, 1980mm	760, 910, 1070, 1220, 1380, 1530mm
<b>SHELF DEPTH</b>	360, 460, 540, 610mm	460, 540, 610mm
<b>POST HEIGHT</b>	<b>Fixed rack</b> 1630, 1830, 2140mm <b>Mobile rack</b> 1780, 1980mm (including castors)	<b>Fixed rack</b> 1630, 1830, 2140mm
<b>MOBILE RACK</b>	Yes	No

### FREE FIRMGRE® DESIGN SERVICE

Trust offers a free shelving system design service to prepare your business's most cost-effective and space maximizing storage solution. Our consultants will plan a system design that addresses your space and storage needs.

Please email [firmgre@trustcommercial.com](mailto:firmgre@trustcommercial.com) with the following information. We will provide you with a proposal within 2 working days.

- Project Name
- Storage room type (freezer/refrigerator/ambient)
- Room size (L x W x H)
- Entrance location and dimensions
- Obstacles (condenser/pipe)
- Other preferences/requirements



## MICROBAN®

### MICROBAN® ANTI-MICROBIAL PROTECTION TECHNOLOGIES

Microban® anti-microbial technologies provide full protection by working to destroy or inhibit the growth and reproduction of bacteria, mold and mildew.



Plastic sample without Microban® anti-microbial ingredients.

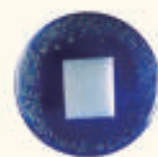

Plastic sample with Microban® anti-microbial ingredients.

\*Microban® is the registered owner of Microban® trademark, and reserves all the rights. Microban® anti-microbial protection is not designed to protect users against disease causing micro-organisms and is not a substitute for routine cleaning.



**Easy clean vented shelf panels**  
Rust free and dishwasher safe



**Maximises storage space**  
Share posts without losing overall load capacity



**Easy to adjust**  
Shelves can be easily adjusted to suit the height of loads

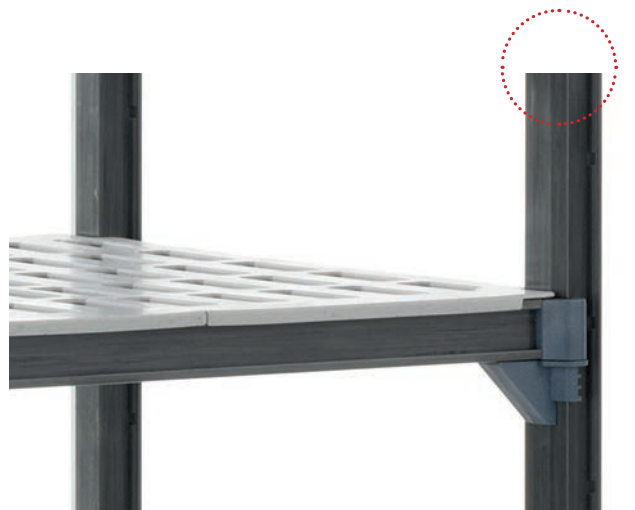

**Internal slots on posts**  
Creates a neat appearance, easy to clean, safer to hold



**Rust and corrosion-free**  
Save on cost of repair and replacement



**Easy adjustment**  
Each shelf can be easily adjusted to suit different stored products

# FOOD STORAGE



## OVERALL LENGTH OF UNITS

### STARTER KIT with EXTENSION

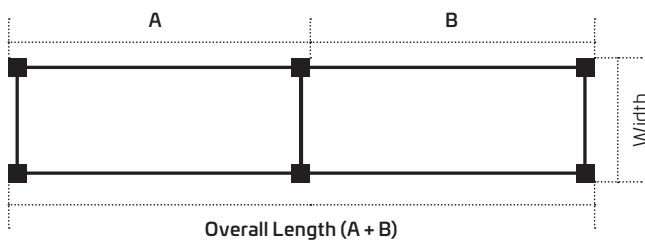

- A = Length of Starter Kit
- B = Length of Extension - 48mm (Standard Firmgre®) or Length of Extension - 36mm (Firmgre® Modus)

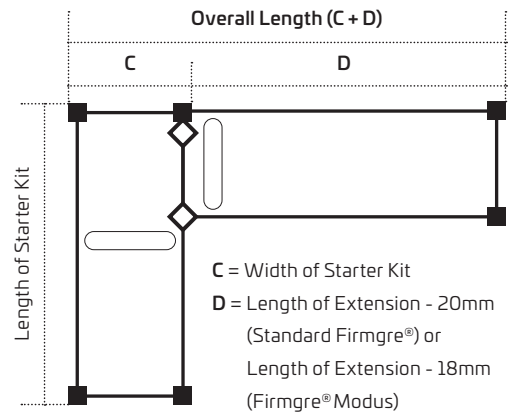

### CORNER UNIT

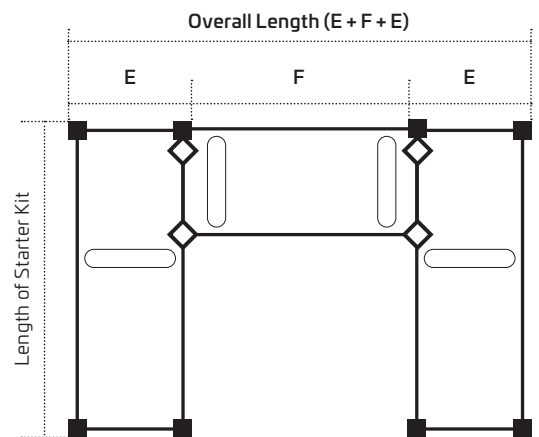

### U-SHAPED UNIT



- E = Width of Starter Kit
- F = Length of Extension - 40mm (Standard Firmgre®) or Length of Extension - 36mm (Firmgre® Modus)

-  **Post:** Share posts to maximise storage space without losing overall load capacity
-  **Corner Connector:** A set of two Corner Connectors required per connecting point.
-  **Dunnage Stand:** 1 Dunnage Stand required for each section of shelves.



## WEIGHT CAPACITY

### STANDARD FIRMGRE® SHELVES

**SINGLE UNIT**  
610 - 1220mm

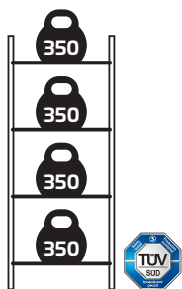

1400kg max  
per unit

**SINGLE UNIT**  
1380 - 1530mm

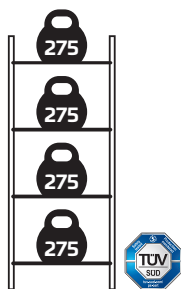

1100kg max  
per unit

**SINGLE UNIT**  
1830 - 1980mm

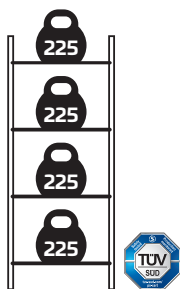

900kg max  
per unit

**SINGLE UNIT**  
1380 - 1530mm  
(Dunnage stand)

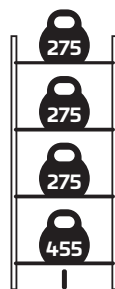

1280kg max  
per unit

**CORNER UNIT**  
610 - 1220mm  
(2 Dunnage stands)

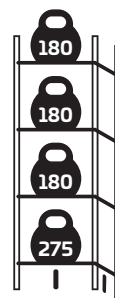

815kg max  
per unit

**MOBILE UNIT**  
910 - 1220mm

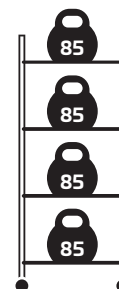

340kg max  
per unit\*

### FIRMGRE® MODUS SHELVES

**SINGLE UNIT**  
760 - 910mm

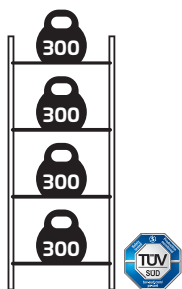

1200kg max  
per unit

**SINGLE UNIT**  
1070 - 1220mm

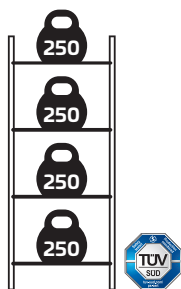

1000kg max  
per unit

**SINGLE UNIT**  
1380 - 1530mm

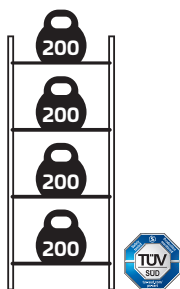

800kg max  
per unit

**SINGLE UNIT**  
1380 - 1530mm  
(Dunnage stand)

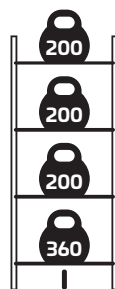

960kg max  
per unit

**CORNER UNIT**  
760 - 1220mm  
(2 Dunnage stands)

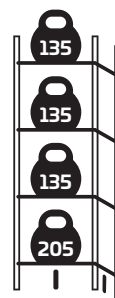

610kg max  
per unit

\* The maximum load of the mobile unit is 340kg, limited by the weight capacity of the castors.

## FIRMGRE® STARTER KITS AND EXTENSIONS

FIRMGRE® Storage Kits come in various configurations to fit any size area.

The 4-shelf Stationary Starter Kits include 2 Stationary Posts and 4 Shelf Kits.

The 4-shelf Stationary Extension Kits come with 1 Stationary Posts and 4 Shelf Kits.

### 4-SHELF STATIONARY STARTER KIT - 360MM WIDE



		LENGTH								
		610mm	760mm	910mm	1070mm	1220mm	1380mm	1530mm	1830mm	1980mm
HEIGHT	1630mm	AX142464	AX143064	AX143664	AX144264	AX144864	AX145464	AX146064	AX147264	AX147864
	1830mm	AX142472	AX143072	AX143672	AX144272	AX144872	AX145472	AX146072	AX147272	AX147872
	2140mm	AX142484	AX143084	AX143684	AX144284	AX144884	AX145484	AX146084	AX147284	AX147884

### 4-SHELF STATIONARY EXTENSION KIT - 360MM WIDE



		LENGTH								
		610mm	760mm	910mm	1070mm	1220mm	1380mm	1530mm	1830mm	1980mm
HEIGHT	1630mm	AE142464	AE143064	AE143664	AE144264	AE144864	AE145464	AE146064	AE147264	AE147864
	1830mm	AE142472	AE143072	AE143672	AE144272	AE144872	AE145472	AE146072	AE147272	AE147872
	2140mm	AE142484	AE143084	AE143684	AE144284	AE144884	AE145484	AE146084	AE147284	AE147884

### 4-SHELF STATIONARY STARTER KIT - 460MM WIDE



		LENGTH								
		610mm	760mm	910mm	1070mm	1220mm	1380mm	1530mm	1830mm	1980mm
HEIGHT	1630mm	AX182464	AX183064	AX183664	AX184264	AX184864	AX185464	AX186064	AX187264	AX187864
	1830mm	AX182472	AX183072	AX183672	AX184272	AX184872	AX185472	AX186072	AX187272	AX187872
	2140mm	AX182484	AX183084	AX183684	AX184284	AX184884	AX185484	AX186084	AX187284	AX187884

### 4-SHELF STATIONARY EXTENSION KIT - 460MM WIDE



		LENGTH								
		610mm	760mm	910mm	1070mm	1220mm	1380mm	1530mm	1830mm	1980mm
HEIGHT	1630mm	AE182464	AE183064	AE183664	AE184264	AE184864	AE185464	AE186064	AE187264	AE187864
	1830mm	AE182472	AE183072	AE183672	AE184272	AE184872	AE185472	AE186072	AE187272	AE187872
	2140mm	AE182484	AE183084	AE183684	AE184284	AE184884	AE185484	AE186084	AE187284	AE187884

### 4-SHELF STATIONARY STARTER KIT - 540MM WIDE



		LENGTH								
		610mm	760mm	910mm	1070mm	1220mm	1380mm	1530mm	1830mm	1980mm
HEIGHT	1630mm	AX212464	AX213064	AX213664	AX214264	AX214864	AX215464	AX216064	AX217264	AX217864
	1830mm	AX212472	AX213072	AX213672	AX214272	AX214872	AX215472	AX216072	AX217272	AX217872
	2140mm	AX212484	AX213084	AX213684	AX214284	AX214884	AX215484	AX216084	AX217284	AX217884

### 4-SHELF STATIONARY EXTENSION KIT - 540MM WIDE



		LENGTH								
		610mm	760mm	910mm	1070mm	1220mm	1380mm	1530mm	1830mm	1980mm
HEIGHT	1630mm	AE212464	AE213064	AE213664	AE214264	AE214864	AE215464	AE216064	AE217264	AE217864
	1830mm	AE212472	AE213072	AE213672	AE214272	AE214872	AE215472	AE216072	AE217272	AE217872
	2140mm	AE212484	AE213084	AE213684	AE214284	AE214884	AE215484	AE216084	AE217284	AE217884

### 4-SHELF STATIONARY STARTER KIT - 610MM WIDE



		LENGTH								
		610mm	760mm	910mm	1070mm	1220mm	1380mm	1530mm	1830mm	1980mm
HEIGHT	1630mm	AX242464	AX243064	AX243664	AX244264	AX244864	AX245464	AX246064	AX247264	AX247864
	1830mm	AX242472	AX243072	AX243672	AX244272	AX244872	AX245472	AX246072	AX247272	AX247872
	2140mm	AX242484	AX243084	AX243684	AX244284	AX244884	AX245484	AX246084	AX247284	AX247884

### 4-SHELF STATIONARY EXTENSION KIT - 610MM WIDE



		LENGTH								
		610mm	760mm	910mm	1070mm	1220mm	1380mm	1530mm	1830mm	1980mm
HEIGHT	1630mm	AE242464	AE243064	AE243664	AE244264	AE244864	AE245464	AE246064	AE247264	AE247864
	1830mm	AE242472	AE243072	AE243672	AE244272	AE244872	AE245472	AE246072	AE247272	AE247872
	2140mm	AE242484	AE243084	AE243684	AE244284	AE244884	AE245484	AE246084	AE247284	AE247884

## FIRMGRE® MOBILE STORAGE KITS

FIRMGRE® Mobile Storage Kits are designed to move between dry storage areas and walk-in fridges quickly and easily. They are made from the same high quality materials as the FIRMGRE® stationary shelves. The weight capacity is 340kg per unit.

The FIRMGRE® 4-Shelf Mobile Shelving Kits come with 2 Mobile Posts and 4 Shelf kits.

### 4-SHELF MOBILE STORAGE KIT - 360MM WIDE



		LENGTH				
		910mm	1070mm	1220mm	1380mm	1530mm
HEIGHT	1780mm	AM143670	AM144270	AM144870	AM145470	AM146070
	1980mm	AM143678	AM144278	AM144878	AM145478	AM146078

### 4-SHELF MOBILE STORAGE KIT - 460MM WIDE



		LENGTH				
		910mm	1070mm	1220mm	1380mm	1530mm
HEIGHT	1780mm	AM183670	AM184270	AM184870	AM185470	AM186070
	1980mm	AM183678	AM184278	AM184878	AM185478	AM186078

### 4-SHELF MOBILE STORAGE KIT - 540MM WIDE



		LENGTH				
		910mm	1070mm	1220mm	1380mm	1530mm
HEIGHT	1780mm	AM213670	AM214270	AM214870	AM215470	AM216070
	1980mm	AM213678	AM214278	AM214878	AM215478	AM216078

### 4-SHELF MOBILE STORAGE KIT - 610MM WIDE



		LENGTH				
		910mm	1070mm	1220mm	1380mm	1530mm
HEIGHT	1780mm	AM243670	AM244270	AM244870	AM245470	AM246070
	1980mm	AM243678	AM244278	AM244878	AM245478	AM246078

## FIRMFIX PARTS

Create a custom storage unit with these parts and accessories to suit different requirements.

### STATIONARY POST KIT



		WIDTH			
		360mm	460mm	540mm	610mm
HEIGHT	1630mm	XY1464	XY1864	XY2164	XY2464
	1830mm	XY1472	XY1872	XY2172	XY2472
	2140mm	XY1484	XY1884	XY2184	XY2484

### MOBILE POST KIT



		WIDTH			
		360mm	460mm	540mm	610mm
HEIGHT	1780mm	XM1470	XM1870	XM2170	XM2470
	1980mm	XM1478	XM1878	XM2178	XM2478

### DUNNAGE STAND



		WIDTH			
		360mm	460mm	540mm	610mm
HEIGHT	165mm	XY1400	XY1800	XY2100	XY2400



Dunnage Stands help to increase the stability and bearing capacity of the bottom shelf and can be applied to any unit. It is recommended to apply Dunnage Stands to all storage units 1380mm wide or longer. They are required for all corner units, U-shape units and units designated for carrying heavy products.

### SHELF KIT



		LENGTH								
		610mm	760mm	910mm	1070mm	1220mm	1380mm	1530mm	1830mm	1980mm
WIDTH	360mm	XX1424	XX1430	XX1436	XX1442	XX1448	XX1454	XX1460	XX1472	XX1478
	460mm	XX1824	XX1830	XX1836	XX1842	XX1848	XX1854	XX1860	XX1872	XX1878
	540mm	XX2124	XX2130	XX2136	XX2142	XX2148	XX2154	XX2160	XX2172	XX2178
	610mm	XX2424	XX2430	XX2436	XX2442	XX2448	XX2454	XX2460	XX2472	XX2478



## FITMIGRE ACCESSORIES



Specially designed **Corner Connectors** to maximize storage spaces

- 1 Corner Connector Set is required per shelf on Corner units.
- 2 Corner Connector Sets are required per shelf for U-shape units.



Easy **clip-on plastic tags** to identify stored items



Easy **clip-on plastic tags** to identify stored items



The shelving unit should be fixed to the wall with the **wall fastener** when necessary to increase the stability. The wall fasteners are made from stainless steel. (screws included)



Fix the posts to the floor with the **Seismic Foot** when necessary for a more stable base. The Seismic foot is made from stainless steel. (screws included)



**Swivel Castors** are suitable for all areas



**Swivel Castors with Brake** are suitable for all areas

Model	Description	Dimensions	Capacity	Color	Pack
XX0001	Corner Connector	5.3 × 4.6 × 3.7cm	N/A	GRAY	1
XX0002	Identification Tag 15cm	15.0 × 3.4 × 0.7cm	N/A	GRAY	12
XX0003	Identification Tag 7.6cm	7.6 × 3.4 × 0.7cm	N/A	GRAY	12
XX0004	Wall Fastener	13.0 × 4.0 × 5.3cm	N/A	SS	4
XX0005	Seismic Foot	11.0 × 9.9 × 8.4cm	N/A	SS	4
XX0006	Swivel Castors	12.0 × 22.5 × 5.3cm	N/A	GRAY	1
XX0007	Swivel Castors with Brake	14.5 × 22.5 × 5.3cm	N/A	GRAY	1



## FIRMGRE® MODUS STORAGE SYSTEM



FIRMGRE® Modus shelving is made of super strong composite material. They are lighter and stronger than ordinary metal shelving. The storage system is specially designed for storing light to medium-sized items in the freezer, refrigerator or utensil cleaning area.

1. Never rust and corrosion, lighter and stronger than ordinary metal shelves.
2. Suitable for all kinds of environments, and can be used at temperatures between -40°C and 90°C.
3. Won't affected by water, chemicals, salts, acid, alkali and humidity.
4. Maximizes storage space with shelves that are designed to share posts without losing overall load capacity.
5. Cleaning can be completed quickly without affecting storage capacity and utility.
6. Each shelf can be easily and individually adjusted to accommodate different items.



### MODUS 4-SHELF STATIONARY STARTER KIT - 460MM WIDE

		LENGTH					
		760mm	910mm	1070mm	1220mm	1380mm	1530mm
HEIGHT	1630mm	BX183064	BX183664	BX184264	BX184864	BX185464	BX186064
	1830mm	BX183072	BX183672	BX184272	BX184872	BX185472	BX186072
	2140mm	BX183084	BX183684	BX184284	BX184884	BX185484	BX186084

### MODUS 4-SHELF STATIONARY EXTENSION KIT - 460MM WIDE

		LENGTH					
		760mm	910mm	1070mm	1220mm	1380mm	1530mm
HEIGHT	1630mm	BE183064	BE183664	BE184264	BE184864	BE185464	BE186064
	1830mm	BE183072	BE183672	BE184272	BE184872	BE185472	BE186072
	2140mm	BE183084	BE183684	BE184284	BE184884	BE185484	BE186084

### MODUS 4-SHELF STATIONARY STARTER KIT - 540MM WIDE

		LENGTH					
		760mm	910mm	1070mm	1220mm	1380mm	1530mm
HEIGHT	1630mm	BX213064	BX213664	BX214264	BX214864	BX215464	BX216064
	1830mm	BX213072	BX213672	BX214272	BX214872	BX215472	BX216072
	2140mm	BX213084	BX213684	BX214284	BX214884	BX215484	BX216084

### MODUS 4-SHELF STATIONARY EXTENSION KIT - 540MM WIDE

		LENGTH					
		760mm	910mm	1070mm	1220mm	1380mm	1530mm
HEIGHT	1630mm	BE213064	BE213664	BE214264	BE214864	BE215464	BE216064
	1830mm	BE213072	BE213672	BE214272	BE214872	BE215472	BE216072
	2140mm	BE213084	BE213684	BE214284	BE214884	BE215484	BE216084

### MODUS 4-SHELF STATIONARY STARTER KIT - 610MM WIDE

		LENGTH					
		760mm	910mm	1070mm	1220mm	1380mm	1530mm
HEIGHT	1630mm	BX243064	BX243664	BX244264	BX244864	BX245464	BX246064
	1830mm	BX243072	BX243672	BX244272	BX244872	BX245472	BX246072
	2140mm	BX243084	BX243684	BX244284	BX244884	BX245484	BX246084

### MODUS 4-SHELF STATIONARY EXTENSION KIT - 610MM WIDE

		LENGTH					
		760mm	910mm	1070mm	1220mm	1380mm	1530mm
HEIGHT	1630mm	BE243064	BE243664	BE244264	BE244864	BE245464	BE246064
	1830mm	BE243072	BE243672	BE244272	BE244872	BE245472	BE246072
	2140mm	BE243084	BE243684	BE244284	BE244884	BE245484	BE246084

## FITTING MODUS STORAGE SYSTEM ACCESSORIES



Specially designed **Corner Connectors** to maximize storage spaces

- 1 Corner Connector Set is required per shelf on Corner units.
- 2 Corner Connector Sets are required per shelf for U-shape units.



Easy **clip-on plastic tags** to identify stored items



Easy **clip-on plastic tags** to identify stored items



The shelving unit should be fixed to the wall with the **wall fastener** when necessary to increase the stability. The wall fasteners are made from stainless steel. (screws included)



Fix the posts to the floor with the **Seismic Foot** when necessary for a more stable base. The Seismic foot is made from stainless steel. (screws included)

Model	Description	Dimensions	Capacity	Color	Pack
XB0001	Modus Corner Connector	4.7 × 4.2 × 3.0cm	N/A	GRAY	1
XB0002	Modus Identification Tag 15cm	15.0 × 2.5 × 0.8cm	N/A	GRAY	12
XB0003	Modus Identification Tag 7.6cm	7.6 × 2.5 × 0.8cm	N/A	GRAY	12
XB0004	Modus Wall Fastener	13.0 × 4.0 × 4.6cm	N/A	SS	4
XB0005	Modus Seismic Foot	9.9 × 9.8 × 8.4cm	N/A	SS	4



## FIRMGR<sup>®</sup> MODUS PARTS

Create a custom storage unit with these parts and accessories to suit different requirements.

### MODUS STATIONARY POST KIT



		WIDTH		
		460mm	540mm	610mm
HEIGHT	1630mm	XA1864	XA2164	XA2464
	1830mm	XA1872	XA2172	XA2472
	2140mm	XA1884	XA2184	XA2484

### MODUS DUNNAGE STAND



		WIDTH		
		460mm	540mm	610mm
HEIGHT	170mm	XA1800	XA2100	XA2400
	270mm	XA1801	XA2101	XA2401



Dunnage Stands help to increase the stability and bearing capacity of the bottom shelf and can be applied to any unit. It is recommended to apply Dunnage Stands to all storage units 1380mm wide or longer. They are required for all corner units, U-shape units and units designated for carrying heavy products.

### MODUS SHELF KIT



		LENGTH					
		760mm	910mm	1070mm	1220mm	1380mm	1530mm
WIDTH	460mm	XB1830	XB1836	XB1842	XB1848	XB1854	XB1860
	540mm	XB2130	XB2136	XB2142	XB2148	XB2154	XB2160
	610mm	XB2430	XB2436	XB2442	XB2448	XB2454	XB2460





## INSULATED BOXES



### PRODUCT FEATURES:

1. Suitable for the preservation of food and beverages.
2. Keeps food and beverages hot or cold without electricity for 12 hours.
3. Specialized interior resists cold, heat and corrosion.
4. Passed relevant tests for compliance with FDA 21 CFR PART 177.1520.
5. Easy to carry with a comfortable handle.
6. 8715 Pull rod design for easy delivery and higher efficiency.



Extendable handle for easier more efficient delivery

Model	Description	Dimensions	Capacity	Color	Pack
8711	Insulated Box	31.5 × 21.0 × 28.0cm	8L	RED	1
8712	Insulated Box	46.7 × 30.5 × 38.3cm	25L	RED	1
8713	Insulated Box	54.5 × 33.5 × 38.5cm	38L	RED	1
8714	Insulated Box	61.5 × 39.0 × 44.5cm	55L	RED	1
8715	Pull Rod Type Insulated Box	52.0 × 30.0 × 47.0cm	48L	RED	1



## INSULATED BOTTLES



### PRODUCT FEATURES:

1. Suitable for the preservation of food and beverages.
2. Keeps food and beverages hot or cold without electricity for 12 hours.
3. Specialized interior resists cold, heat and corrosion.
4. Passed relevant tests for compliance with FDA 21 CFR PART 177.1520.
5. Easy to use with the comfortable handle.



8721

Model	Description	Dimensions	Capacity	Color	Pack
8721	Insulated Bottle	21.2 × 17.0 × 28.5cm	2.5L	RED	1

## COLD DRINK COOLBOXES



### PRODUCT FEATURES:

1. Suitable for the preservation of food and beverages.
2. Keeps food and beverages hot or cold without electricity for 12 hours.
3. Specialized interior resists cold, heat and corrosion.
4. Passed relevant tests for compliance with FDA 21 CFR PART 177.1520.
5. Comfortable handles on both sides for easy operation.
6. High quality valve and perfectly airtight.



8701



8702



8703

Model	Description	Dimensions	Capacity	Color	Pack
8701	Cold Drink Coolbox	30.5 × 34.0 × 30.0cm	10L	RED	1
8702	Cold Drink Coolbox	40.0 × 34.0 × 48.0cm	20L	RED	1
8703	Cold Drink Coolbox	47.0 × 41.0 × 54.0cm	55L	RED	1



**INSULATED  
PRODUCTS**

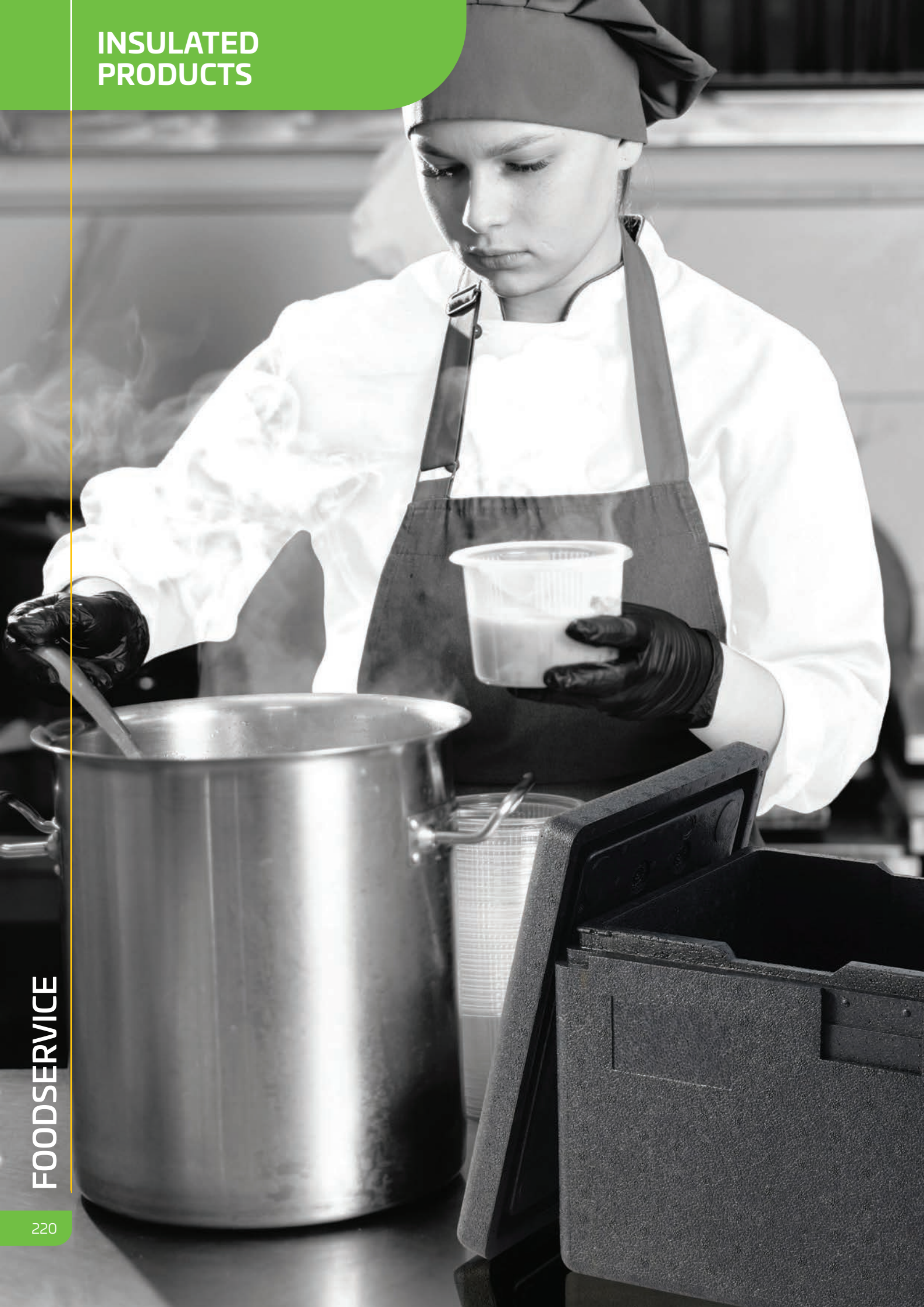

# EXCEBOX® INSULATED FOOD CARRIERS

Trust has a large selection of food delivery equipment, providing our customers a wide range of options. We will design the optimum system to help grow your business and build a loyal following for your brand, while maintaining food safety and quality.

## Ensuring food safety and quality

When it comes to food processing every second is crucial. From the first moment of food preparation right through to delivery to the customer. Every step of the way, EXCEBOX® helps to keep food at the temperature it should be, hot or cold.

EXCEBOX® Insulated Food Carriers are suitable for a range of applications such as:

- Delivery of food materials and ingredients
- Counter-top storage for pickup or delivery
- Food delivery to the end user

## Keeping employees safe

EXCEBOX® Insulated Food Carriers are made from high-tech materials with an ergonomic design, enhancing workplace safety for employees. Notable features include.

- Ultra lightweight construction
- Safe and sturdy carrying straps
- Specially designed carts for transporting bulk catering orders



**Thermal insulation**  
Keeps food hot or cold for over 4 hours.



**Ultra light**  
Made of EPP (Expanded Polypropylene Polystyrene - an environmentally friendly high-performance foam material) making your meal delivery incredibly easy.



**High structural strength**  
Able to bear a large load while maintaining its shape and style.



**Superior cushioning**  
Able to withstand significant impact without damage.



**Dishwasher safe**



**Corrosion resistance**  
Not affected by oil, grease and most chemicals.



**100% recyclable**



**Compatible with GN food pans**  
Ensures food safety and meets HACCP requirements for storage and transportation systems.

## EXCEBOX® INSULATED FOOD CARRIERS

The EXCEBOX® System is the perfect solution for catering and food service operators. The System provides excellent thermal insulation ensuring appropriate food safety. They are made of environmentally friendly, high-performance insulation - Expanded Polypropylene Polystyrene (EPP) - and are incredibly lightweight, making your meal delivery incredibly easy.

The EXCEBOX® System is an affordable solution, which offers the durability needed to cope with frequent commercial use.

- Keeps food at a safe temperature for over 4 hours.
- Perfect for storing food waiting to be picked up.
- Ideal for multiple stops or large events.
- Stackable.
- One of the most economical food transfer solutions.

### Temperature Holding Performance

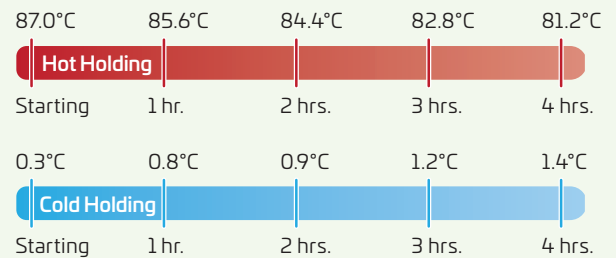

**Note:** Work best with food trays temperature range between 82 to 88°C.

Loading metal food trays above 120°C will damage the EXCEBOX® carrier.





## FRONT-LOADING EXCEBOX®

### PRODUCT FEATURES:

1. Beveled doors for easy door opening and closing.
2. Durable hinges and latches that allow the front loading EXCEBOX® to open up to 270° for easy access.
3. Built-in handles on all 4 sides, make it easy to carry.
4. Built-in condensation barrier helps stop dripping.
5. Use the built-in label area to keep plastic labels in place to easily identify contents or provide route directions.
6. Can be stacked securely to save space.



8879

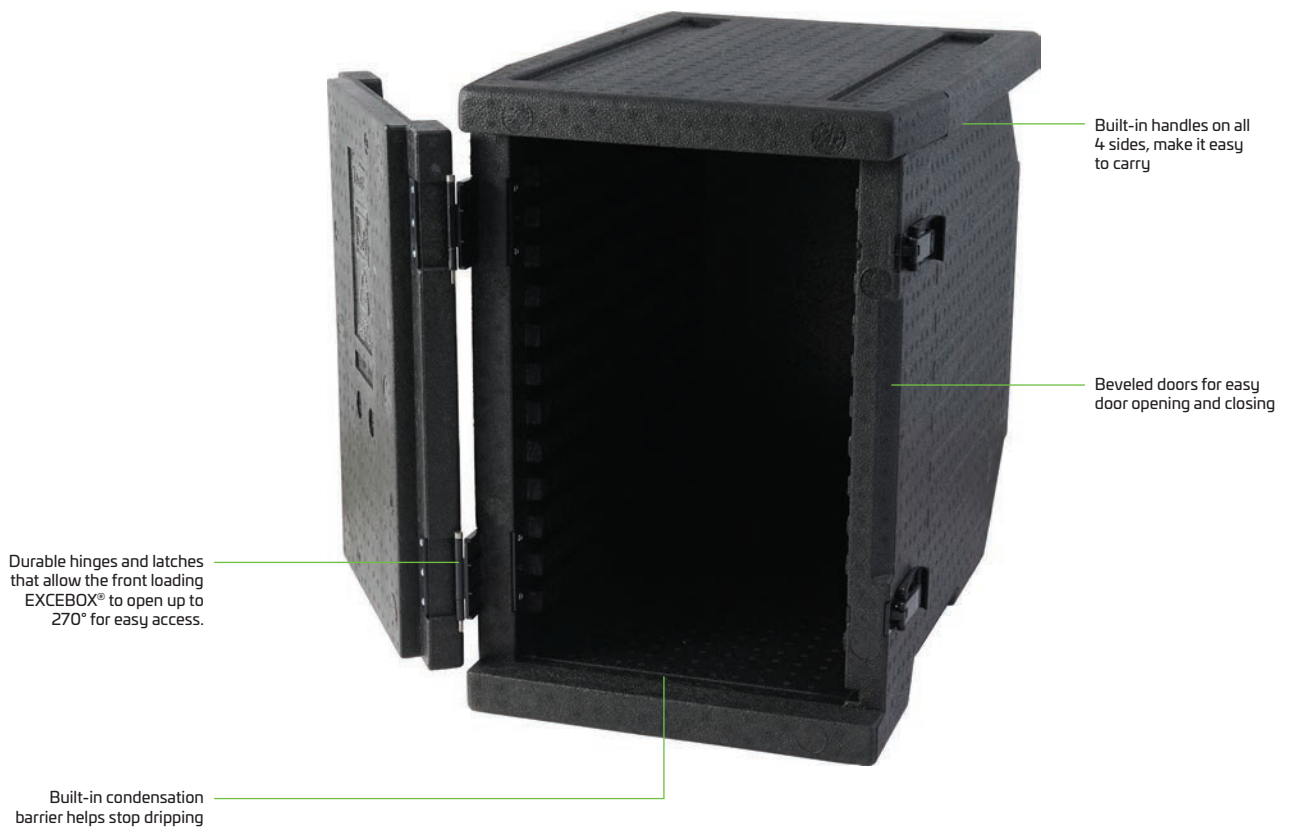

Durable hinges and latches that allow the front loading EXCEBOX® to open up to 270° for easy access.

Built-in condensation barrier helps stop dripping

Built-in handles on all 4 sides, make it easy to carry

Beveled doors for easy door opening and closing



Can be stacked firmly to save space



Model	Description	Exterior Dimensions	Interior Dimensions	Volume	Weight	Suitable For Use With	Color	Pack
8879	Front-Loading EXCEBOX® 47.5cm Height	64.0 × 44.0 × 47.5cm	53.5 × 33.0 × 37.0cm	60.0L	3.3kg	GN1/1 Food Pan	BLA	1
8880	Front-Loading EXCEBOX® 62.5cm Height	64.0 × 44.0 × 62.5cm	53.5 × 33.0 × 52.5cm	86.0L	4.0kg	GN1/1 Food Pan	BLA	1
8881	Front-Loading EXCEBOX® without Rail	77.0 × 54.0 × 68.7cm	61.5 × 41.0 × 58.5cm	155.0L	6.2kg	60 × 40cm Crates	BLA	1
8882	Front-Loading EXCEBOX® with 6 Rails	77.0 × 54.0 × 68.7cm	61.5 × 41.0 × 58.5cm	126.0L	6.4kg	60 × 40cm Food Tray	BLA	1
8883	Front-Loading EXCEBOX® with 9 Rails	77.0 × 54.0 × 68.7cm	61.5 × 41.0 × 58.5cm	126.0L	6.7kg	60 × 40cm Food Tray	BLA	1

- 8879/8880 suitable for loading GN1/1 food trays.
- 8881 is designed for loading 60 × 40cm crates; 8881 used with Adjustable Rail Kit (8890) to load both 60 × 40cm crates and food trays.
- 8882/8883 are suitable for loading 60 × 40cm food trays.

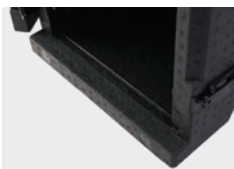

Built-in **condensation barrier** helps stop dripping



**Stackable** to save space



Use the **built-in label area** to keep plastic labels in place to easily identify contents or provide route directions

## TOP-LOADING EXCEBOX®

### PRODUCT FEATURES:

1. Internal grooves for easy loading and unloading of GN 1/1 or GN 1/2 food pans.
2. Comfortable ergonomic handles for easy and safe handling.
3. Use the built-in label area to keep plastic labels in place to easily identify contents or provide route directions.
4. Can be stacked securely to save space.



8870

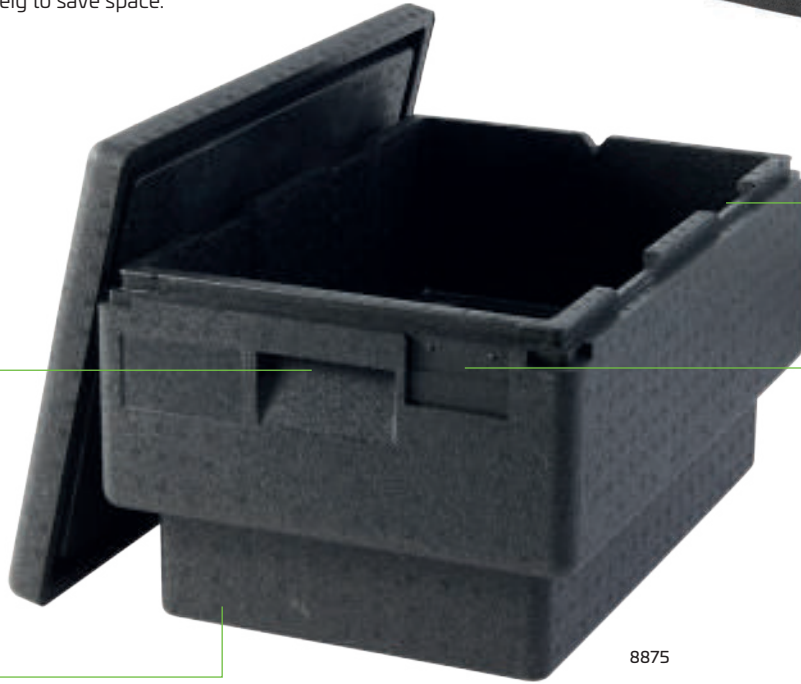

Comfortable handles for easy and safe handling

Internal grooves for easy loading and unloading of GN 1/1 food pans

Use the built-in label area to keep plastic labels in place to easily identify contents or provide route directions

Can be stacked securely to save space

8875



Model	Description	Exterior Dimensions	Interior Dimensions	Volume	Weight	Suitable For Use With	Color	Pack
8870	GN1/2 EXCEBOX® 25.7cm Height	39.0 × 33.0 × 25.7cm	33.0 × 27.0 × 19.3cm	16.9L	0.7kg	GN1/2 15cm Deep Food Pan	BLA	1
8871	GN1/2 EXCEBOX® 31.6cm Height	39.0 × 33.0 × 31.6cm	33.0 × 27.0 × 25.3cm	22.3L	0.8kg	GN1/2 20cm Deep Food Pan	BLA	1
8872	GN1/2 EXCEBOX® with Carrying Handle	39.0 × 33.0 × 31.6cm	33.0 × 27.0 × 25.3cm	22.3L	0.9kg	GN1/2 20cm Deep Food Pan	BLA	1
8873	GN1/1 EXCEBOX® 25.7cm Height	60.0 × 40.0 × 25.7cm	53.8 × 33.8 × 19.3cm	35.5L	1.2kg	GN1/1 15cm Deep Food Pan	BLA	1
8874	GN1/1 EXCEBOX® 31.6cm Height	60.0 × 40.0 × 31.6cm	53.8 × 33.8 × 25.3cm	46.0L	1.3kg	GN1/1 20cm Deep Food Pan	BLA	1
8875	GN1/1 EXCEBOX® Stackable	TOP 60.0 × 40.0 × 18.2cm BOTTOM 53.6 × 33.6 × 10.0cm	TOP 53.8 × 33.8 × 15.9cm BOTTOM 50.4 × 30.2 × 9.5cm	43.0L	1.2kg	GN1/1 20cm Deep Food Pan	BLA	1
8876	GN1/1 EXCEBOX® with Ergonomic Handles	68.0 × 40.0 × 32.1cm	53.8 × 35.5 × 25.5cm	46.0L	1.4kg	GN1/1 20cm Deep Food Pan	BLA	1
8877	6040 EXCEBOX® 27.0cm Height	69.0 × 49.0 × 27.0cm	62.5 × 42.5 × 20.5cm	53.0L	1.6kg	60 × 40cm Food Tray	BLA	1
8878	6040 EXCEBOX® 37.0cm Height	69.0 × 49.0 × 37.0cm	62.5 × 42.5 × 30.5cm	80.0L	1.9kg	60 × 40cm Food Tray	BLA	1



8872



8876



8878

Fits GN food  
pans perfectly

## EXCEBOX® ACCESSORIES



**Plastic Labels - 5 Pack - Red / Yellow / Blue / Green / White (8884)** are ideal for easy content identification or routing.



Comprising stainless steel frames and 2 sets of rails, the **Adjustable Rail Kit (8890)** is flexible and can fit food pans and trays of different heights.



**Warmer (8887)** designed to extend the hot holding time of your food.



**Cooler (8885/8886)** designed to extend the cold holding time of your food.



**Dolly (8888/8889)** specially designed to fit all EXCEBOX®.



**Lid (8891)** GN 1/2 lid designed to fit Top-loading EXCEBOX®.



**Lid (8892)** GN 1/1 lid designed to fit Top-loading EXCEBOX®.

Model	Description	Dimensions	Suitable For Use With	Color	Pack
8884	Plastic Labels	8.7 x 5.3 cm	All EXCEBOX®	N/A	1
8885	GN1/2 Cooler	32.5 x 26.5 x 3.1cm	8870/8871/8872	BLUE	1
8886	GN1/1 Cooler	53.0 x 32.5 x 3.1cm	8873/8874/8875/8876/8879/8880	BLUE	1
8887	GN1/1 Warmer	53.0 x 32.5 x 3.1cm	8873/8874/8875/8876/8879/8880	RED	1
8888	Dolly	67.6 x 43.6 x 17.3cm	8873/8874/8875/8876/8879/8880	BLA	1
8889	Dolly	75.5 x 51.7 x 16.5cm	8877/8878/8881/8882/8883	BLA	1
8890	Adjustable Rail Kit	N/A	8881	SS	1
8891	GN 1/2 Lid for Top-loading EXCEBOX®	39.0 x 33.0 x 3.6cm	8870/8871/8872	BLUE, YEL, GRN, RED, BLA, ORA	6
8892	GN 1/1 Lid for Top-loading EXCEBOX®	60.0 x 40.0 x 3.6cm	8873/8874/8875	BLUE, YEL, GRN, RED, BLA, ORA	6



## Food Pan Configuration Examples

### Top-loading

8870 / 8873



### Top-loading

8871 / 8872 / 8874 / 8876



### Top-loading

8875

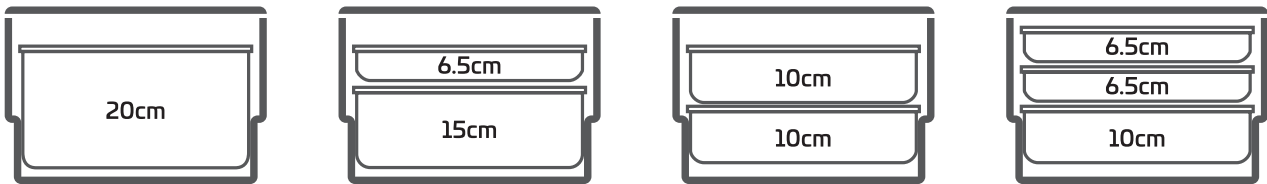

### Front-loading

8879

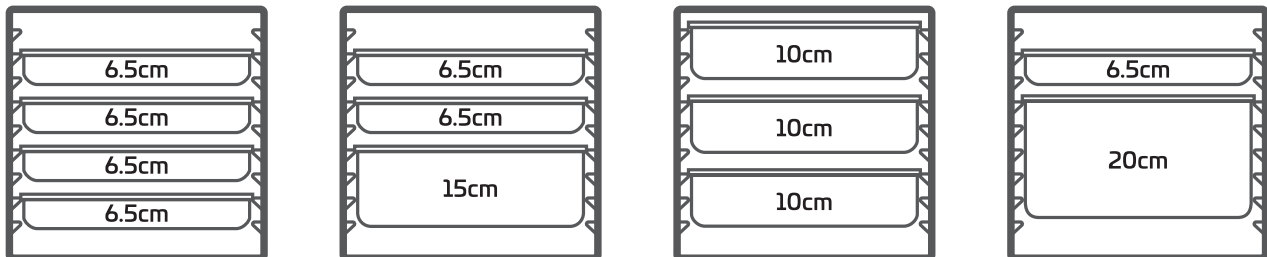

### Front-loading

8880

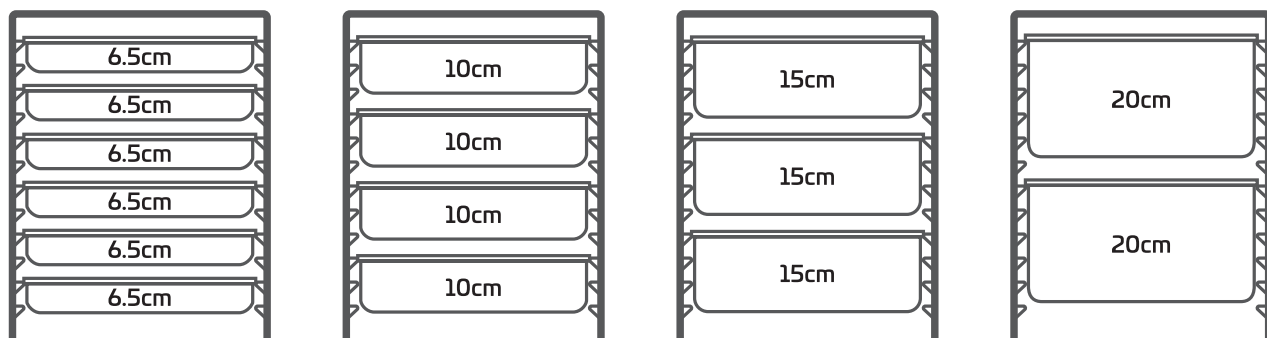



## FOOD STORAGE RACKS/CARTS



### PRODUCT FEATURES:

1. An effective aid for food preparation, transportation, supplying and storage.
2. Multi-purpose systems are designed to work with food trays, food boxes, and food pans up to GB, European and American standards.
3. All plastic web structure ensures strength and durability.
4. Rounded edge design won't damage walls, doors and other equipment.
5. High temperature resistant plastic structure (up to 176°C) allows for direct rack contact with oven-hot baking trays.
6. Quiet castor design and elegant appearance allow for quick restocking of food directly from the kitchen to the dining hall.
7. 12.7cm non-marking castors, two of which have braking function, offer easy maneuverability.
8. Complies with NSF # 2 inspection standards.
9. Please contact distributors for customization.



8621

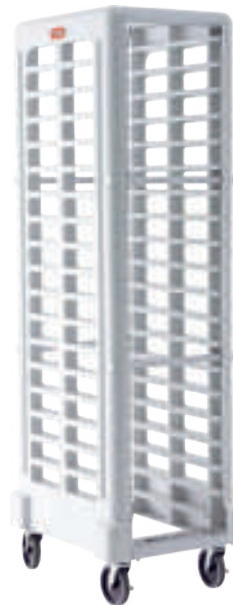

8613



8614



**Rounded edge design** won't damage walls, doors and other equipment



**12.7cm non-marking castors**, two of which have braking function, offer easy maneuverability

### 8613/8621 Food Cart

Front loading type  
Shelf width: 33.0cm  
Suitable for food box/pan size:

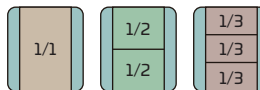

### 8614/8622 Food Cart

Side loading type  
Shelf width: 66.4cm  
Suitable for food box/pan size:

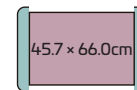

### 8615 Food Cart

Side loading type  
Shelf width: 65.4cm  
Suitable for food box/pan size:

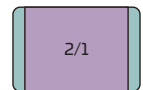

Model	Description	Dimensions	Tray Number	Color	Pack
8613	Food Storage Rack/Cart	60.3 × 47.3 × 172.4cm	17	BLA, OWHT	1
8614	Food Storage Rack/Cart	80.6 × 60.3 × 172.4cm	17	BLA, OWHT	1
8615	Food Storage Rack/Cart	79.6 × 60.3 × 172.4cm	17	BLA, OWHT	1
8621	Food Storage Rack/Cart	60.3 × 47.3 × 91.8cm	8	BLA, OWHT	1
8622	Food Storage Rack/Cart	80.6 × 60.3 × 91.8cm	8	BLA, OWHT	1

# ADJUSTABLE TRAY & DISH CARTS

## PRODUCT FEATURES:

1. Stores 10.8 to 29.8cm plates and bowls.
2. Totally adjustable columns to fit the size of plates and bowls.
3. Structural web technology enhances resistance to tableware damage.
4. Resistant to rust, dents and scratches.
5. Optimized ergonomic handle is comfortable to use.
6. 12.5cm non-marking castors, two of which have braking function, offer easy maneuverability.
7. Rounded corners protect wall, doors and appliances.
8. Stackable for convenient storage and space saving.
9. Dust cover included.



8651

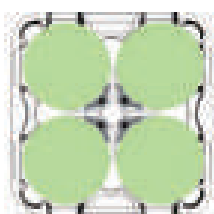

Plate Size: Dia 24.4 to 29.8cm  
4 Columns (60 each)  
Total Capacity: 240

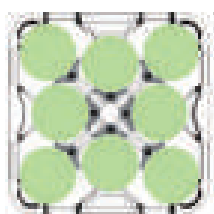
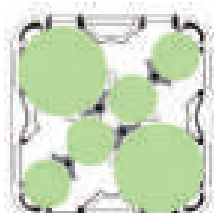
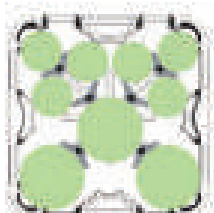

Plate Size: Dia 16.5 to 18.7cm  
8 Columns (45 each)  
Total Capacity: 360



2 Columns:  
Dia 24.4 to 29.8cm (45 each)  
4 Columns:  
Dia 16.5 to 18.7cm (45 each)  
Total Capacity: 300



3 Columns:  
Dia 19.1 to 21.6cm (60 each)  
6 Columns:  
Dia 12.1 to 13.7cm (45 each)  
Total Capacity: 450

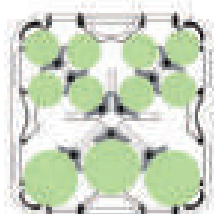

3 Columns:  
Dia 16.5 to 18.7cm (45 each)  
8 Columns:  
Dia 10.8 to 11.7cm (45 each)  
Total Capacity: 495

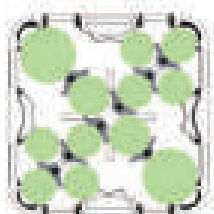

2 Columns:  
Dia 16.5 to 18.7cm (45 each)  
2 Columns:  
Dia 12.1 to 13.7cm (45 each)  
8 Columns:  
Dia 10.8 to 11.7cm (45 each)  
Total Capacity: 540



Stackable for convenient storage and space saving

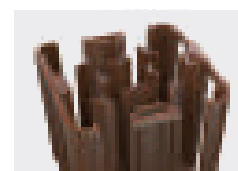

Four side handle is easy to operate

## MICROBAN®

### MICROBAN® ANTI-MICROBIAL PROTECTION TECHNOLOGIES

Microban® anti-microbial technologies provide full protection by working to destroy or inhibit the growth and reproduction of bacteria, mold and mildew.



Model	Description	Dimensions	Capacity	Color	Pack
8651	Adjustable Tray&Dish Cart	68.0 × 68.0 × 81.0cm	N/A	BLA, DBRN, SGRAY	1
8652	Column	11.5 × 6.5 × 59.8cm	N/A	BLA, DBRN, SGRAY	2
8653	Dust Cover	68.5 × 68.5 × 60.0cm	N/A	CLR	2

## OEASY® PLATFORM TRUCKS



### PRODUCT FEATURES:

1. Perfect for transporting heavy loads in any environment.
2. User friendly handles help to maneuver the cart and ensure the safety of operators.
3. Molded-in structure adds strength and durability, and prolongs the service life.
4. Textured surfaces for non-skid and safe transporting.
5. Grooves close to edges help prevent small items against from rolling out.
6. Notches on both sides are for secure latching of transported goods.
7. Flexible fixing clip helps to prevent accidental release of the handle while allowing easy disassembly.
8. Durable powder-coated steel handle.



Model	Description	Deck Size	Dimensions	Load	Castor Type	Pack
4411	OEASY® Platform Trucks	91.4 × 61.0cm	101.9 × 61.0 × 100.6cm	450kg	15.0 × 5.0cm TPR	1
4413	OEASY® Platform Trucks	121.9 × 61.0cm	132.4 × 61.0 × 105.7cm	900kg	20.0 × 5.0cm TPR	1

## HIS® UTILITY SERVICE CARTS



### PRODUCT FEATURES:

1. Versatile, functional and a workhorse in any facility.
2. Molded shelves won't rust, dent, or chip.
3. Performs multiple duties: stocking cart, turndown cart, self-serving food kiosk, mobile beverage server.
4. Sized for smaller properties or restocking.
5. Quiet, non-marking swivel castors.



Model	Description	Dimensions	Load	Color	Pack
4010	HIS® Utility Cart, 2-shelf Unit	85.4 × 47.3 × 96.0cm	60kg	GRAY, BLA, PLAT, OWHT	1
4011	HIS® Utility Cart, Open Sided	85.4 × 47.3 × 96.0cm	90kg	GRAY, BLA, PLAT, OWHT	1
4021	HIS® Utility Cart, Open Sided	103.2 × 50.8 × 96.0cm	135kg	GRAY, BLA, OWHT	1
4023	HIS® Utility Cart with Enclosed End Panels on 3 Sides	103.2 × 50.8 × 96.0cm	135kg	BLA, OWHT	1

# HIS® FOLDING SERVICE CARTS

## PRODUCT FEATURES:

1. Versatile, durable for indoor mobility.
2. Molded shelves, sturdy and durable won't rust, dent, peel.
3. Fully functional and innovative folding mechanism. Carts can be easily folded and opened, saving 50% of the space after folding.
4. Quick locking device to ensure no loosening after opening and folding.
5. Comfortable ergonomic handle for more flexible control.
6. Textured surfaces for non-skid and safe transporting.
7. Spacious countertop for the 4072 cart, which can place two bus boxes (8221) at the same time.
8. 10cm quiet non-marking castors which serve to reduce noise and subsequent floor maintenance; Universal wheel with brake function is more stable when working.



4071



4072

Ergonomic handle for more flexible control

Innovative folding cart save storage space by 50%

Non-slip textured surfaces



Comfortable ergonomic handle for more flexible control



Quick locking device to ensure no loosening after opening and folding



Innovative folding mechanism makes it easier to open and fold



10cm quiet, non-marking castors

Model	Description	Dimensions	Load	Color	Pack
4071	HIS® Foldable Service Cart	75.0 × 41.2 × 92.0cm	160kg	GRAY, BLA, BRN	1
4072	HIS® Foldable Service Cart	102.5 × 52.3 × 92.0cm	160kg	GRAY, BLA, BRN	1

## HI5® UTILITY SERVICE CARTS



### PRODUCT FEATURES:

1. Sturdy and durable, fully functional carts, suitable for handling work in the front and back-of-house.
2. Molded, formed structure of the carts is sturdy and durable - will not rust, dent or come apart.
3. Ergonomic, comfortable handle provides flexible control.
4. Textured surfaces for non-skid and safe transporting.
5. With a spacious countertop, two lower railing basins can be placed at the same time (8211).
6. 10cm quiet non-marking castors which serve to reduce noise and subsequent floor maintenance.
7. The Sundry barrels (4811, 4821) can be placed on both sides to increase the collection capacity.



4081



4082



4083



4084

Model	Description	Dimensions	Load	Color	Pack
4081	HI5® Utility Cart	111.6 × 54.0 × 95.6cm	135kg	BLA	1
4082	HI5® Utility Cart with Enclosed End Panels on 3 Sides	111.6 × 54.0 × 95.6cm	135kg	BLA	1
4083	HI5® Utility Cart with Lockable Doors, Sliding Drawer	111.6 × 54.0 × 95.6cm	135kg	BLA	1
4084	HI5® Utility Cart with Lockable Doors, Enclosed Panels	111.6 × 54.0 × 95.6cm	135kg	BLA	1

## ACCESSORIES



4811



4821



4851

Model	Description	Dimensions	Capacity	Color	Pack
4085	Enclosed Panels	N/A	N/A	BLA	1
4086	Lockable Doors	N/A	N/A	BLA	1
4087	Trim Panel	50.6 × 30.8 × 3.7cm	N/A	BLA	1
4811	Utility Bin	43.2 × 30.8 × 26.7cm	15L	BLA	2
4821	Utility Bin	43.2 × 30.8 × 55.9cm	30L	BLA	2
4851	Utility Sliding Drawer	65.7 × 46.0 × 8.2cm	N/A	BLA, BRN	1



## BITBAR® UTILITY CARTS



### PRODUCT FEATURES:

1. Innovative design for easy transportation of a variety of items.
2. Sturdy structural foam construction won't rust, dent, chip, or peel.
3. Molded-in storage compartments and cup holder are available for storing small items and tools.
4. User-friendly, comfortable handles for easy maneuverability.
5. Integrated molded grooves for inserting steel tube or metal reeled coils or other coil-like items.

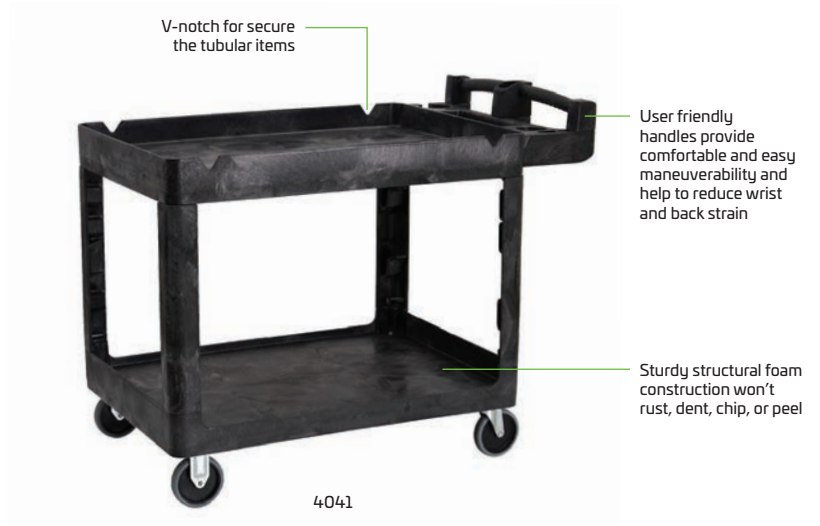

Model	Description	Dimensions	Load	Color	Castor Type	Pack
4041	BITBAR® 2-shelf Utility Cart	115.0 × 64.1 × 98.7cm	230kg	BLA, BEIG	12.5cm TPR	1
4044	BITBAR® 2-shelf Utility Cart	97.8 × 43.5 × 98.7cm	230kg	BLA, BEIG	12.5cm TPR	1

## BITBAR® FLAT-SHELF CARTS



### PRODUCT FEATURES:

1. Innovative design for easily transporting a variety of items.
2. Sturdy structural foam construction won't rust, dent, chip, or peel.
3. Molded-in storage compartments and cup holder are available for storage of small items and tools.
4. User-friendly, comfortable handles for easy maneuverability.
5. Integrated molded grooves for inserting steel tubes or metal reeled coils or other coil-like items.



Model	Description	Dimensions	Load	Color	Castor Type	Pack
4045	BITBAR® 2-shelf Utility Cart Flat Shelf	97.8 × 43.5 × 96.8cm	230kg	BLA, BEIG	12.5cm TPR	1



## UTILITY TROLLEYS



### PRODUCT FEATURES:

1. Efficiently transports large bulky loads, and then folds flat for easy storage.
2. Sturdy structural foam deck won't rust, dent, chip, or peel.
3. Non-skid platform surface helps prevent load shifting.
4. Three-position handle lets users push, pull or fold flat for use as a dolly.
5. Non marking castors.



Model	Description	Dimensions	Load	Color	Pack
4481	Utility Trolley, Utility Duty with 7.5cm Castors	85.0 × 52.1cm	110kg	BLA	1
4482	Utility Trolley, Standard Duty with 12.5cm Castors	85.0 × 52.1cm	230kg	BLA	1

## GLASS RACK TROLLEYS



### PRODUCT FEATURES:

1. Suitable for carrying cup racks.
2. Reduces work load and promotes efficiency.
3. Plastic reticulation construction won't dent, chip, rust and is sturdy and reliable.
4. Non-marking swivel castors ensure easy maneuverability.
5. Concave design captures water left by glasses.



Model	Description	Dimensions	Load	Color	Pack
4484	Glass Rack Dolly	52.5 × 52.5 × 20.0cm	160kg	GRAY, PLAT	1
4485	Glass Rack Trolley	64.0 × 52.5 × 94.0cm	160kg	GRAY, PLAT	1

## CATERING DISKS



### PRODUCT FEATURES:

1. Adds to strength and durability.
2. Curved handle for easy operation and added strength.
3. Textured surface prevents slippage.
4. Stackable for easy storage.

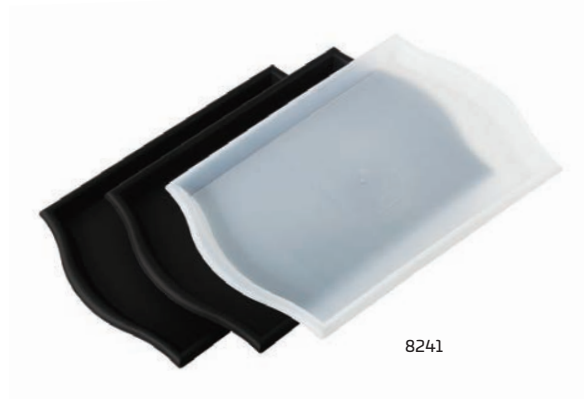

8241

Model	Description	Dimensions	Capacity	Color	Pack
8241	Catering Disk	40.0 x 30.5cm	N/A	BLA, STRAN	12

## GRP NON-SLIP TRAYS



### PRODUCT FEATURES:

1. GRP construction ensures strength, durability, resistance to impact and chemical corrosion.
2. Non-slip surface prevents items from falling off.
3. Steel and aluminum reinforced ring adds to strength and rigidity and prevents crushing and deformation.
4. Designed with a stacking boss to allow air circulation, facilitate pallet drying and offer easy placement.
5. Complies with relevant NSF inspection standards.



8251/8252/8253/8254

8255/8256/8257/8258

8267/8268/8269

Model	Description	Dimensions	Capacity	Color	Pack
8250	Round GRP Non-slip Tray	Dia 23.0cm	N/A	BRN	12
8251	Round GRP Non-slip Tray	Dia 27.5cm	N/A	BRN	12
8252	Round GRP Non-slip Tray	Dia 35.5cm	N/A	BRN	12
8253	Round GRP Non-slip Tray	Dia 40.6cm	N/A	BRN	12
8254	Round GRP Non-slip Tray	Dia 45.0cm	N/A	BRN	12
8255	Rectangular GRP Non-slip Tray	35.0 x 25.5cm	N/A	BRN	12
8256	Rectangular GRP Non-slip Tray	40.5 x 30.5cm	N/A	BRN	12
8257	Rectangular GRP Non-slip Tray	45.5 x 36.5cm	N/A	BRN	12
8258	Rectangular GRP Non-slip Tray	51.0 x 38.0cm	N/A	BRN	12
8259	Rectangular GRP Non-slip Tray	56.0 x 40.5cm	N/A	BRN	12
8260	Rectangular GRP Non-slip Tray	65.0 x 45.0cm	N/A	BRN	12
8267	Oval GRP Non-slip Tray	51.0 x 64.0cm	N/A	BRN	6
8268	Oval GRP Non-slip Tray	56.0 x 69.0cm	N/A	BRN	6
8269	Oval GRP Non-slip Tray	60.0 x 74.0cm	N/A	BRN	6

## PP NON-SLIP TRAYS



### PRODUCT FEATURES:

1. PP structure is economical, durable, and chemical resistant.
2. Non-slip surface prevents items from falling off.
3. Designed with a stacking boss to allow air circulation, facilitate pallet drying and offer easy placement.



8281/8282



8287/8288

Model	Description	Dimensions	Capacity	Color	Pack
8281	Round PP Non-slip Tray	Dia 27.5cm	N/A	BRN	12
8282	Round PP Non-slip Tray	Dia 35.5cm	N/A	BRN	12
8283	Round PP Non-slip Tray	Dia 40.6cm	N/A	BRN	12
8284	Round PP Non-slip Tray	Dia 45.0cm	N/A	BRN	12
8285	Rectangle PP Non-slip Tray	35.0 × 25.5cm	N/A	BRN	12
8286	Rectangle PP Non-slip Tray	40.5 × 30.5cm	N/A	BRN	12
8287	Rectangle PP Non-slip Tray	45.5 × 36.5cm	N/A	BRN	12
8288	Rectangle PP Non-slip Tray	51.0 × 38.0cm	N/A	BRN	12

## WOOD GRAIN NON-SLIP TRAYS



### PRODUCT FEATURES:

1. Made of wood fiber, anti-corrosive and durable, not prone to mold, environmentally friendly and degradable.
2. Non-slip surface prevents items from falling off.
3. Dishwasher safe.



8270/8271



8272/8273/8274



8276/8277/8278

Model	Description	Dimensions	Capacity	Color	Pack
8270	Round Wood Grain Non-slip Tray	Dia 39.3cm	N/A	ASH, WAL	12
8271	Round Wood Grain Non-slip Tray	Dia 50.8cm	N/A	ASH, WAL	12
8272	Rectangle Wood Grain Non-slip Tray	35.5 × 22.8 × 1.6cm	N/A	ASH, WAL	12
8273	Rectangle Wood Grain Non-slip Tray	43.2 × 29.0 × 1.6cm	N/A	ASH, WAL	12
8274	Rectangle Wood Grain Non-slip Tray	50.8 × 36.0 × 1.7cm	N/A	ASH, WAL	12
8275	Rectangle Wood Grain Non-slip Tray	58.4 × 39.0 × 1.8cm	N/A	ASH, WAL	12
8276	Oval Wood Grain Non-slip Tray	35.5 × 22.8 × 1.6cm	N/A	ASH, WAL	12
8277	Oval Wood Grain Non-slip Tray	43.2 × 29.0 × 1.6cm	N/A	ASH, WAL	12
8278	Oval Wood Grain Non-slip Tray	50.8 × 36.0 × 1.7cm	N/A	ASH, WAL	12
8279	Oval Wood Grain Non-slip Tray	58.4 × 39.0 × 1.8cm	N/A	ASH, WAL	12





## SCRAPPER/SPOON-SHAPED SCRAPPERS



### PRODUCT FEATURES:

1. A multipurpose tool combining spoon, scoop and scrapper.
2. Body and handle are integrally molded to eliminate the possibility of coming off.
3. Seamless structure eliminates the retention of dirt and bacteria.
4. The convex design on the back of scrapper prevents the contact between the blade and the worktable for reducing the possibility of food contamination.
5. Traditional flat scrapper is for scraping; Spoon-shaped scrapper is used to scoop, dig and wipe.
6. All the handle and body are white.
7. Found in compliance with NSF # 2 inspection standards.
8. Dishwasher safe.



Model	Description	Dimensions	Capacity	Color	Pack
8511	Scrapper	24.0cm	N/A	WHT	36
8512	Scrapper	34.0cm	N/A	WHT	36
8513	Scrapper	42.0cm	N/A	WHT	36
8514	Ice Scrapper	24.0cm	N/A	WHT	36
8515	Spoon-shaped Scrapper	24.0cm	N/A	WHT	36
8516	Spoon-shaped Scrapper	34.0cm	N/A	WHT	36
8517	Spoon-shaped Scrapper	42.0cm	N/A	WHT	36

# CHOPPING BOARDS



## PRODUCT FEATURES:

1. An ideal tool to ensure safety in working.
2. HDPE molded structure ensures strength and durability.
3. Chopping board color recognition system is the first step to ensure food safety.
4. Red boards are used for raw meat, blue for seafood, brown for cooked meat, green for fruits and vegetables, yellow for poultry and white for dairy.
5. Stainless steel Chopping board holder is safe, clean and durable.
6. A cleaning brush, which is sold separately, can be hung on the Chopping board holder.
7. Found in compliance with NSF standards.



8522/8523



8525/8529



8529



8523

Model	Description	Dimensions	Thickness	Color	Pack
8520	Chopping Board	30.0 × 23.0 × 1.2cm	1.2cm	BLUE, GRN, RED, YEL, WHT, BRN	6
8521	Chopping Board	50.8 × 30.8 × 1.5cm	1.5cm	BLUE, GRN, RED, YEL, WHT, BRN	6
8522	Chopping Board Set (6 Colors)	50.8 × 30.8 × 1.5cm	1.5cm	N/A	1
8523	Chopping Board Holder	30.6 × 28.2 × 28.6cm	N/A	MSILV	1
8524	Chopping Board	60.6 × 45.5 × 1.5cm	1.5cm	BLUE, GRN, RED, YEL, WHT, BRN	6
8525	Chopping Board	50.8 × 30.8 × 2.0cm	2.0cm	BLUE, GRN, RED, YEL, WHT, BRN	6
8526	Chopping Board	45.5 × 30.8 × 1.5cm	1.5cm	BLUE, GRN, RED, YEL, WHT, BRN	6
8527	Chopping Board	50.8 × 45.5 × 2.0cm	2.0cm	BLUE, GRN, RED, YEL, WHT, BRN	6
8528	Chopping Board	60.6 × 60.6 × 2.0cm	2.0cm	BLUE, GRN, RED, YEL, WHT, BRN	6
8529	Chopping Board Holder	26.3 × 35.2 × 21.6cm	N/A	BLA	1



## CUPCOMB® WAREWASHING SYSTEM



The CUPCOMB® warewashing system has been designed to maximise washing, handling and storage efficiency for restaurants, hotels, hospitals and commercial operations.

The system is engineered for maximum capacity and flexibility with a wide variety of racks and extenders to suit modern catering requirements. With the CUPCOMB system operators will save time, money and resources and help prevent breakage and loss.

As an integrated, fully sealed and mobile storage unit the CUPCOMB system is the optimum warewashing logistics system for catering operations: economical, safe and efficient.

The CUPCOMB® System comprises the CUPCOMB® Cover, CUPCOMB® Racks and CUPCOMB® Dolly to provide an integrated, fully sealed and mobile unit.

### PRODUCT FEATURES:

1. Designed for maximum capacity per rack, reducing the number of washing cycles and ultimately saving time and money.
2. Engineered for better washing.
3. Enclosed racks and spacers prevent finger marking and keep dirt away.
4. Color-coded tray racks for easy inventory management.
5. Up to 6 different heights by adding extenders to the base rack.
6. Optional Quick Check Label Clips for easy content identification.
7. With the optional Dolly inventory can be moved easily and safely from one location to another.



## CUPFORM® FULL SIZE GLASS RACKS

### PRODUCT FEATURES:

1. Designed for maximum capacity per rack, reducing the number of washing cycles and ultimately saving time and money.
2. Engineered for better washing.
3. Enclosed racks and spacers prevent finger marking and keep dirt away.
4. Color-coded tray racks for easy inventory management.
5. Up to 6 different heights by adding extenders to the base rack.
6. Optional Quick Check Label Clips for easy content identification.
7. With the optional Dolly inventory can be moved easily and safely from one location to another.



9362

## CUPFORM® FULL SIZE GLASS RACKS - 9 COMPARTMENT

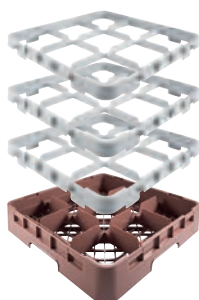

Model	Description	Max Diameter	Max Height	Dimensions	Color	Pack
9090	Base Rack	14.8cm	N/A	50.0 × 50.0 × 10.2cm	LGRAY, RBRN	6
9091	Base Rack with 1 Extender	14.8cm	9.0cm	50.0 × 50.0 × 14.3cm	N/A	5
9092	Base Rack with 2 Extender	14.8cm	13.3cm	50.0 × 50.0 × 18.4cm	N/A	4
9093	Base Rack with 3 Extender	14.8cm	17.5cm	50.0 × 50.0 × 22.5cm	N/A	3
9094	Base Rack with 4 Extender	14.8cm	21.6cm	50.0 × 50.0 × 26.7cm	N/A	2
9095	Base Rack with 5 Extender	14.8cm	25.8cm	50.0 × 50.0 × 30.8cm	N/A	2
9096	Base Rack with 6 Extender	14.8cm	30.0cm	50.0 × 50.0 × 34.9cm	N/A	2

## CUPFORM® FULL SIZE GLASS RACKS - 16 COMPARTMENT

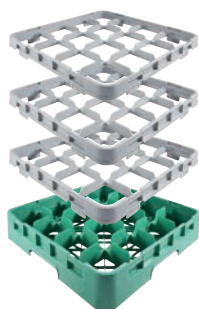

Model	Description	Max Diameter	Max Height	Dimensions	Color	Pack
9160	Base Rack	10.9cm	N/A	50.0 × 50.0 × 10.2cm	LGRAY, SGRN	6
9161	Base Rack with 1 Extender	10.9cm	9.0cm	50.0 × 50.0 × 14.3cm	N/A	5
9162	Base Rack with 2 Extender	10.9cm	13.3cm	50.0 × 50.0 × 18.4cm	N/A	4
9163	Base Rack with 3 Extender	10.9cm	17.5cm	50.0 × 50.0 × 22.5cm	N/A	3
9164	Base Rack with 4 Extender	10.9cm	21.6cm	50.0 × 50.0 × 26.7cm	N/A	2
9165	Base Rack with 5 Extender	10.9cm	25.8cm	50.0 × 50.0 × 30.8cm	N/A	2
9166	Base Rack with 6 Extender	10.9cm	30.0cm	50.0 × 50.0 × 34.9cm	N/A	2

## CUPFORM® FULL SIZE GLASS RACKS - 20 COMPARTMENT



Model	Description	Max Diameter	Max Height	Dimensions	Color	Pack
9200	Base Rack	9.8cm	N/A	50.0 × 50.0 × 10.2cm	LGRAY, GRAY	6
9201	Base Rack with 1 Extender	9.8cm	9.0cm	50.0 × 50.0 × 14.3cm	N/A	5
9202	Base Rack with 2 Extender	9.8cm	13.3cm	50.0 × 50.0 × 18.4cm	N/A	4
9203	Base Rack with 3 Extender	9.8cm	17.5cm	50.0 × 50.0 × 22.5cm	N/A	3
9204	Base Rack with 4 Extender	9.8cm	21.6cm	50.0 × 50.0 × 26.7cm	N/A	2
9205	Base Rack with 5 Extender	9.8cm	25.8cm	50.0 × 50.0 × 30.8cm	N/A	2
9206	Base Rack with 6 Extender	9.8cm	30.0cm	50.0 × 50.0 × 34.9cm	N/A	2

## CUPCOMB FULL SIZE GLASS RACKS - 25 COMPARTMENT

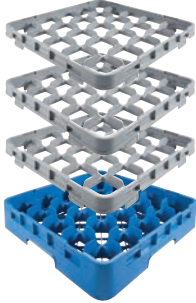

Model	Description	Max Diameter	Max Height	Dimensions	Color	Pack
9250	Base Rack	8.7cm	N/A	50.0 × 50.0 × 10.2cm	LGRAY, IND	6
9251	Base Rack with 1 Extender	8.7cm	9.0cm	50.0 × 50.0 × 14.3cm	N/A	5
9252	Base Rack with 2 Extender	8.7cm	13.3cm	50.0 × 50.0 × 18.4cm	N/A	4
9253	Base Rack with 3 Extender	8.7cm	17.5cm	50.0 × 50.0 × 22.5cm	N/A	3
9254	Base Rack with 4 Extender	8.7cm	21.6cm	50.0 × 50.0 × 26.7cm	N/A	2
9255	Base Rack with 5 Extender	8.7cm	25.8cm	50.0 × 50.0 × 30.8cm	N/A	2
9256	Base Rack with 6 Extender	8.7cm	30.0cm	50.0 × 50.0 × 34.9cm	N/A	2

## CUPCOMB FULL SIZE GLASS RACKS - 30 COMPARTMENT

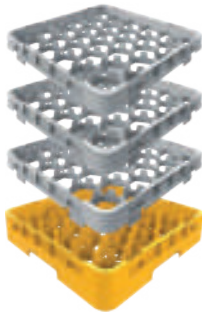

Model	Description	Max Diameter	Max Height	Dimensions	Color	Pack
9300	Base Rack	7.9cm	N/A	50.0 × 50.0 × 10.2cm	LGRAY, YEL	6
9301	Base Rack with 1 Extender	7.9cm	9.0cm	50.0 × 50.0 × 14.3cm	N/A	5
9302	Base Rack with 2 Extender	7.9cm	13.3cm	50.0 × 50.0 × 18.4cm	N/A	4
9303	Base Rack with 3 Extender	7.9cm	17.5cm	50.0 × 50.0 × 22.5cm	N/A	3
9304	Base Rack with 4 Extender	7.9cm	21.6cm	50.0 × 50.0 × 26.7cm	N/A	2
9305	Base Rack with 5 Extender	7.9cm	25.8cm	50.0 × 50.0 × 30.8cm	N/A	2
9306	Base Rack with 6 Extender	7.9cm	30.0cm	50.0 × 50.0 × 34.9cm	N/A	2

## CUPCOMB FULL SIZE GLASS RACKS - 36 COMPARTMENT

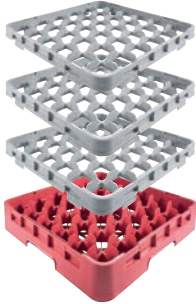

Model	Description	Max Diameter	Max Height	Dimensions	Color	Pack
9360	Base Rack	7.2cm	N/A	50.0 × 50.0 × 10.2cm	LGRAY, LRED	6
9361	Base Rack with 1 Extender	7.2cm	9.0cm	50.0 × 50.0 × 14.3cm	N/A	5
9362	Base Rack with 2 Extender	7.2cm	13.3cm	50.0 × 50.0 × 18.4cm	N/A	4
9363	Base Rack with 3 Extender	7.2cm	17.5cm	50.0 × 50.0 × 22.5cm	N/A	3
9364	Base Rack with 4 Extender	7.2cm	21.6cm	50.0 × 50.0 × 26.7cm	N/A	2
9365	Base Rack with 5 Extender	7.2cm	25.8cm	50.0 × 50.0 × 30.8cm	N/A	2
9366	Base Rack with 6 Extender	7.2cm	30.0cm	50.0 × 50.0 × 34.9cm	N/A	2

## CUPCOMB FULL SIZE GLASS RACKS - 49 COMPARTMENT

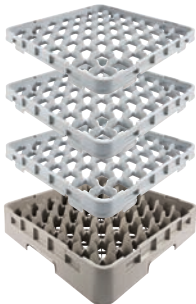

Model	Description	Max Diameter	Max Height	Dimensions	Color	Pack
9490	Base Rack	6.0cm	N/A	50.0 × 50.0 × 10.2cm	LGRAY, LBEIG	6
9491	Base Rack with 1 Extender	6.0cm	9.0cm	50.0 × 50.0 × 14.3cm	N/A	5
9492	Base Rack with 2 Extender	6.0cm	13.3cm	50.0 × 50.0 × 18.4cm	N/A	4
9493	Base Rack with 3 Extender	6.0cm	17.5cm	50.0 × 50.0 × 22.5cm	N/A	3
9494	Base Rack with 4 Extender	6.0cm	21.6cm	50.0 × 50.0 × 26.7cm	N/A	2
9495	Base Rack with 5 Extender	6.0cm	25.8cm	50.0 × 50.0 × 30.8cm	N/A	2
9496	Base Rack with 6 Extender	6.0cm	30.0cm	50.0 × 50.0 × 34.9cm	N/A	2

## CUPCOMB® HALF SIZE GLASS RACKS



### PRODUCT FEATURES:

1. Designed for maximum capacity per rack, reducing the number of washing cycles and ultimately saving time and money.
2. Engineered for better washing.
3. Enclosed racks and spacers prevent finger marking and keep dirt away.
4. Color-coded tray racks for easy inventory management.
5. Up to 6 different heights by adding extenders to the base rack.
6. Half-sized racks are useful for carrying lighter loads than full-sized racks and for handy storage of drinkware where space is at a premium.
7. Ideal for use with smaller under-bench dishwashers.
8. Optional Quick Check Label Clips for easy content identification.



9101

## CUPCOMB® HALF SIZE GLASS RACKS - 8 COMPARTMENT



Model	Description	Max Diameter	Max Height	Dimensions	Color	Pack
9080	Base Rack	10.3cm	N/A	50.0 × 25.0 × 10.2cm	LGRAY, SGRN	6
9081	Base Rack with 1 Extender	10.3cm	9.0cm	50.0 × 25.0 × 14.3cm	N/A	5
9082	Base Rack with 2 Extender	10.3cm	13.3cm	50.0 × 25.0 × 18.4cm	N/A	4
9083	Base Rack with 3 Extender	10.3cm	17.5cm	50.0 × 25.0 × 22.5cm	N/A	3
9084	Base Rack with 4 Extender	10.3cm	21.6cm	50.0 × 25.0 × 26.7cm	N/A	2
9085	Base Rack with 5 Extender	10.3cm	25.8cm	50.0 × 25.0 × 30.8cm	N/A	2
9086	Base Rack with 6 Extender	10.3cm	30.0cm	50.0 × 25.0 × 34.9cm	N/A	2

## CUPCOMB® HALF SIZE GLASS RACKS - 10 COMPARTMENT



Model	Description	Max Diameter	Max Height	Dimensions	Color	Pack
9100	Base Rack	8.8cm	N/A	50.0 × 25.0 × 10.2cm	LGRAY, IND	6
9101	Base Rack with 1 Extender	8.8cm	9.0cm	50.0 × 25.0 × 14.3cm	N/A	5
9102	Base Rack with 2 Extender	8.8cm	13.3cm	50.0 × 25.0 × 18.4cm	N/A	4
9103	Base Rack with 3 Extender	8.8cm	17.5cm	50.0 × 25.0 × 22.5cm	N/A	3
9104	Base Rack with 4 Extender	8.8cm	21.6cm	50.0 × 25.0 × 26.7cm	N/A	2
9105	Base Rack with 5 Extender	8.8cm	25.8cm	50.0 × 25.0 × 30.8cm	N/A	2
9106	Base Rack with 6 Extender	8.8cm	30.0cm	50.0 × 25.0 × 34.9cm	N/A	2

## CUPCOMB® HALF SIZE GLASS RACKS - 17 COMPARTMENT



Model	Description	Max Diameter	Max Height	Dimensions	Color	Pack
9170	Base Rack	7.3cm	N/A	50.0 × 25.0 × 10.2cm	LGRAY, LRED	6
9171	Base Rack with 1 Extender	7.3cm	9.0cm	50.0 × 25.0 × 14.3cm	N/A	5
9172	Base Rack with 2 Extender	7.3cm	13.3cm	50.0 × 25.0 × 18.4cm	N/A	4
9173	Base Rack with 3 Extender	7.3cm	17.5cm	50.0 × 25.0 × 22.5cm	N/A	3
9174	Base Rack with 4 Extender	7.3cm	21.6cm	50.0 × 25.0 × 26.7cm	N/A	2
9175	Base Rack with 5 Extender	7.3cm	25.8cm	50.0 × 25.0 × 30.8cm	N/A	2
9176	Base Rack with 6 Extender	7.3cm	30.0cm	50.0 × 25.0 × 34.9cm	N/A	2

## CUPCOMB® BASE AND FLATWARE RACKS



### PRODUCT FEATURES:

1. Base Racks are designed for larger objects such as pots, frying pans, lids and larger food preparation and utility items.
2. Flatware racks are ideal for washing, soaking and storing flatware.
3. Available in full size or half size.
4. Use half-sized flatware racks for carrying lighter loads and for effective use of space.
5. Configure to 4 different heights by adding extenders to the base rack.



9610



9601

### CUPCOMB® BASE RACK – FULL SIZE

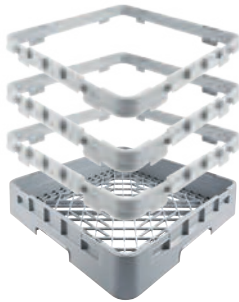

Model	Description	Inside Rack Height	Outside Rack Height	Dimensions	Color	Pack
9600	Base Rack	8.3cm	10.1cm	50.0 × 50.0 × 10.1cm	LGRAY	6
9601	Base Rack with 1 Extender	12.4cm	14.3cm	50.0 × 50.0 × 14.3cm	LGRAY	5
9602	Base Rack with 2 Extender	16.5cm	18.4cm	50.0 × 50.0 × 18.4cm	LGRAY	4
9603	Base Rack with 3 Extender	20.6cm	22.5cm	50.0 × 50.0 × 22.5cm	LGRAY	3

### CUPCOMB® BASE RACK – HALF SIZE



Model	Description	Inside Rack Height	Outside Rack Height	Dimensions	Color	Pack
9610	Base Rack	8.3cm	10.1cm	50.0 × 25.0 × 10.1cm	LGRAY	6
9611	Base Rack with 1 Extender	12.4cm	14.3cm	50.0 × 25.0 × 14.3cm	LGRAY	5
9612	Base Rack with 2 Extender	16.5cm	18.4cm	50.0 × 25.0 × 18.4cm	LGRAY	4
9613	Base Rack with 3 Extender	20.6cm	22.5cm	50.0 × 25.0 × 22.5cm	LGRAY	3

### CUPCOMB® FLATWARE RACK – FULL AND HALF SIZE



Model	Description	Inside Rack Height	Outside Rack Height	Dimensions	Color	Pack
9650	Flatware Rack – Full Size	6.7cm	10.1cm	50.0 × 50.0 × 10.1cm	LGRAY	6
9651	Flatware Rack – Half Size	6.7cm	10.1cm	50.0 × 25.0 × 10.1cm	LGRAY	6



## GUPPECOMB® PEG RACK



### PRODUCT FEATURES:

1. Peg racks come in a 9 × 9 or a 5 × 9 row configuration.
2. They are designed to accommodate different sized plates, bowls, platters and other items.
3. 9 × 9 Peg Rack is suitable for storing:
  - 18 plates at 25.4cm
  - 12 plates at 30.5cm
  - 27 plates at 19cm or
  - 9 trays at 36 × 46cm
4. 5 × 9 Peg Rack is suitable for storing:
  - standard dinner plates in one direction and soup plates, bowls and lids in the other direction.
  - 10 bowls, plates or lids at 25.4cm.
5. Color-coded tray racks for easy inventory management.
6. Optional Quick Check Label Clips for easy content identification.



9631

## GUPPECOMB® PEG RACK - 5 × 9

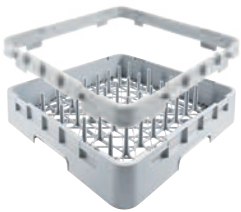

Model	Description	Inside Rack Height	Outside Rack Height	Dimensions	Color	Pack
9620	5 × 9 Peg Rack	6.7cm	10.1cm	50.0 × 50.0 × 10.1cm	LGRAY	6
9621	Base Rack with 1 Extender	10.8cm	14.3cm	50.0 × 50.0 × 14.3cm	LGRAY	5

## GUPPECOMB® PEG RACK - 9 × 9

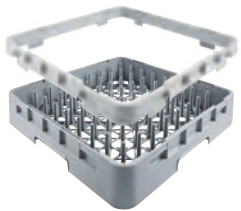

Model	Description	Inside Rack Height	Outside Rack Height	Dimensions	Color	Pack
9630	9 × 9 Peg Rack	6.7cm	10.1cm	50.0 × 50.0 × 10.1cm	LGRAY	6
9631	Base Rack with 1 Extender	10.8cm	14.3cm	50.0 × 50.0 × 14.3cm	LGRAY	5

## GUPPECOMB® TRAY RACK



### PRODUCT FEATURES:

1. Open-ended tray racks hold up to 9 serving trays or full-size baking trays with ease.
2. The open-ended design aids placement and removal of trays of various lengths. Color-coded tray racks for easy inventory management.
3. Optional Quick Check Label Clips for easy content identification.



9640

## GUPPECOMB® TRAY RACK

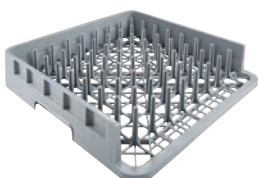

Model	Description	Inside Rack Height	Outside Rack Height	Dimensions	Color	Pack
9640	Open End Tray Rack	6.7cm	10.1cm	50.0 × 50.0 × 10.1cm	LGRAY	6

## GUPCOMB® FLATWARE BASKET



### PRODUCT FEATURES:

1. Easily load and wash utensils and flatware.

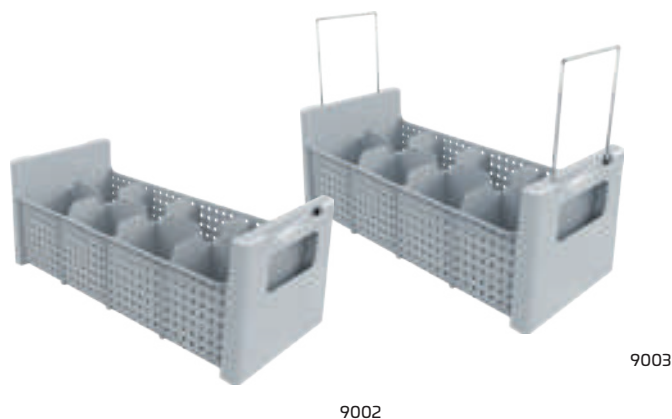

Model	Description	Dimensions	Capacity	Color	Pack
9002	8 Compartment Half Size Flatware Basket	46.0 × 21.0 × 18.0cm	N/A	LGRAY	6
9003	8 Compartment Half Size Flatware Basket with Handle	46.0 × 21.0 × 18.0cm	N/A	LGRAY	6

## GUPCOMB® EXTENDER



### PRODUCT FEATURES:

1. Up to 6 different heights by adding extenders to the base rack.

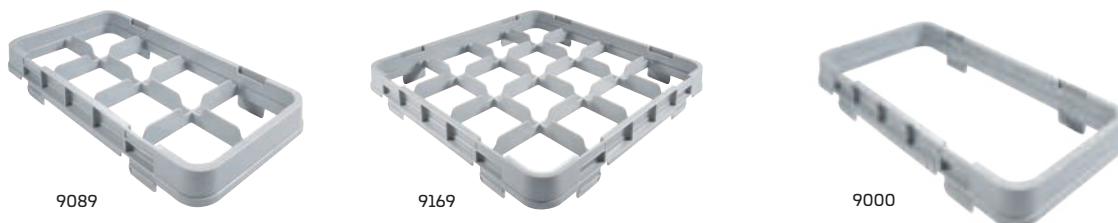

Model	Description	Max Diameter	Max Height	Dimensions	Color	Pack
9099	9 Compartment Full Size Extender	14.8cm	N/A	49.7 × 49.7 × 7.8cm	LGRAY	12
9169	16 Compartment Full Size Extender	10.9cm	N/A	49.7 × 49.7 × 7.8cm	LGRAY	12
9209	20 Compartment Full Size Extender	9.8cm	N/A	49.7 × 49.7 × 7.8cm	LGRAY	12
9259	25 Compartment Full Size Extender	8.7cm	N/A	49.7 × 49.7 × 7.8cm	LGRAY	12
9309	30 Compartment Full Size Extender	7.9cm	N/A	49.7 × 49.7 × 7.8cm	LGRAY	12
9369	36 Compartment Full Size Extender	7.2cm	N/A	49.7 × 49.7 × 7.8cm	LGRAY	12
9499	49 Compartment Full Size Extender	6.0cm	N/A	49.7 × 49.7 × 7.8cm	LGRAY	12
9089	8 Compartment Half Size Extender	10.3cm	N/A	50.0 × 25.0 × 7.8cm	LGRAY	12
9109	10 Compartment Half Size Extender	8.8cm	N/A	50.0 × 25.0 × 7.8cm	LGRAY	12
9179	17 Compartment Half Size Extender	7.3cm	N/A	50.0 × 25.0 × 7.8cm	LGRAY	12
9009	Full Size Open Extender	N/A	N/A	50.0 × 50.0 × 7.8cm	LGRAY	12
9000	Half Size Open Extender	N/A	N/A	50.0 × 25.0 × 7.8cm	LGRAY	12

## ACCESSORIES



- The CUPCOMB® Cover fits neatly and securely over any CUPCOMB® Rack.
- Effectively seals the contents beneath preventing food and other contaminants from falling through. It also helps provides secure protection of the contents to reduce breakage. Use it with a CUPCOMB® Dolly for handy, portable and sanitary storage.
- Ideal for transporting stacked dish racks for high efficiency.
- Equipped with non-marking, heavy-duty castors that help to easily maneuver across various surface types.
- Heavy duty plastic construction ensures a long service life.
- Sturdy edges and angled side walls ensure excess water is collected in the Dolly base and not spread across floors when moving.
- Quick Check Label Clips aid efficiency by helping the user to choose the correct rack without the need to inspect the contents.
- 34 different types of pre-printed label clips are available (refer below).
- Label Clips can also be branded with a company logo.

## QUICK CHECK LABEL CLIPS

<b>Beer</b> 9901	<b>Beer Mug</b> 9902	<b>Brandy</b> 9903	<b>Champagne</b> 9904	<b>Champagne Mug</b> 9905	<b>Coffee Mug</b> 9906	<b>Collins</b> 9907
<b>Cordial</b> 9908	<b>Creamer</b> 9909	<b>Cup</b> 9910	<b>Decanter</b> 9911	<b>Flatware</b> 9912	<b>Goblet</b> 9913	<b>Grande</b> 9914
<b>Hi-Ball</b> 9915	<b>Hurricane</b> 9916	<b>Iced Tea</b> 9917	<b>Irish Coffee</b> 9918	<b>Juice</b> 9919	<b>Margarita</b> 9920	<b>Martini</b> 9921
<b>Old Fashion</b> 9922	<b>Pilsner</b> 9923	<b>Red Wine</b> 9924	<b>Rocks (Footed)</b> 9925	<b>Rocks (Tumbler)</b> 9926	<b>Sherry</b> 9927	<b>Shot Glass</b> 9928
<b>Sorbent</b> 9929	<b>Water (Footed)</b> 9930	<b>Water (Tumbler)</b> 9931	<b>White Wine</b> 9932	<b>Wine</b> 9933	<b>Port</b> 9934	

Model	Description	Dimensions	Capacity	Color	Pack
4484	Dolly	52.5 x 52.5 x 20.0cm	N/A	GRAY, PLAT	1
4485	Dolly with Handle	64.0 x 52.5 x 94.0cm	N/A	GRAY, PLAT	1
9001	Half Size Cover	50.0 x 25.0 x 3.2cm	N/A	WHT	1
9008	Full Size Cover	50.0 x 50.0 x 3.2cm	N/A	GRN, RED, WHT	1
See Above	Label Clip	6.0 x 4.5 x 0.6cm	N/A	WHT	12



## HOW TO PICK THE RIGHT CUPCOMP® RACK

There is a size guide provided on page 327 of this brochure. Using the guide, you can choose the right CUPCOMP® rack which best suited to your drinkware.



### DIAMETER

Place the glass upside down over the circular chart. Look down over the glass. Use whichever circle is of the largest diameter - either the glass base, body or rim to determine which compartment rack size the glass fits within.

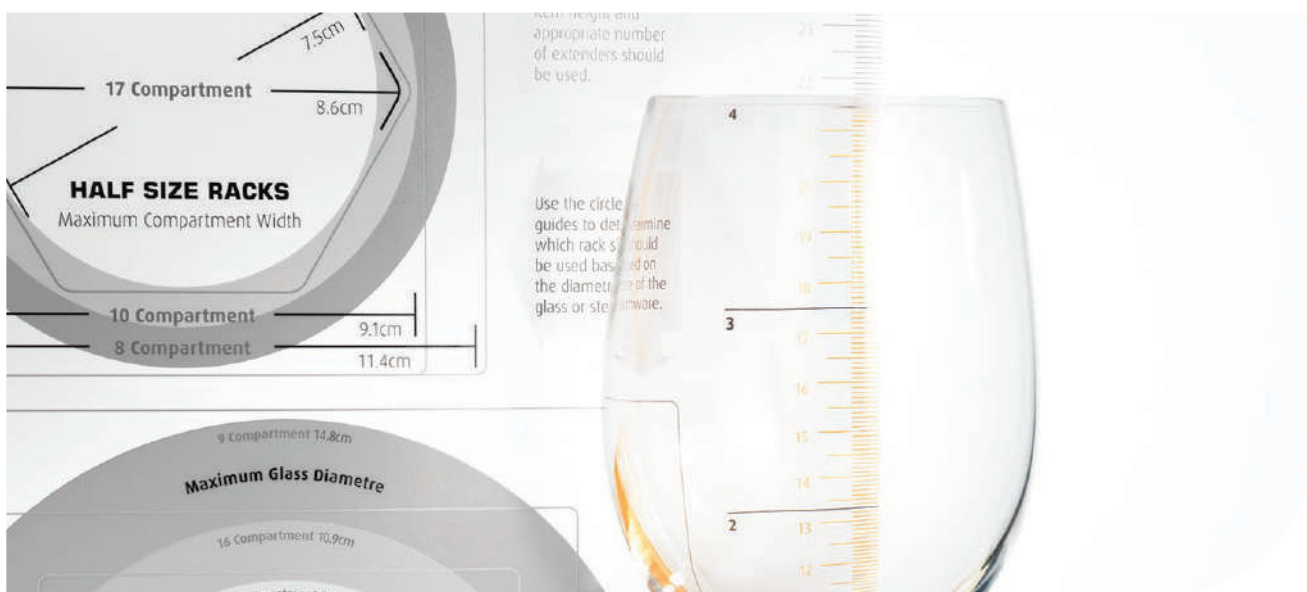

### HEIGHT

Use the vertical guide to determine the number of extenders that should be used. If the height of the glass is between two extenders, select the higher extender.



# TOTE BOXES



## TOTE BOXES



### PRODUCT FEATURES:

1. Reinforced handles, bottom and ribs for added strength and durability.
2. Rounded corners for easy cleaning.
3. Commercial dishwasher safe.



8211



8212



8216



8222



8221



8226

Model	Description	Dimensions	Capacity	Color	Pack
8211	Bus/Utility Box	50.0 × 37.5 × 12.7cm	17L	GRAY, WHT, BRN	12
8212	Bus/Utility Box	50.8 × 38.1 × 17.8cm	23L	GRAY, WHT	12
8216	Lid for 8211/8212	51.1 × 38.7 × 1.5cm	N/A	GRAY, WHT	12
8220	Bus/Utility Box	54.6 × 43.5 × 12.7cm	20L	GRAY, BRN	6
8221	Bus/Utility Box	54.6 × 43.5 × 17.8cm	29L	GRAY, BRN	6
8222	Divided Bus/Utility Box	54.6 × 43.5 × 18.2cm	26L	GRAY, BRN	6
8226	Lid for 8220/8221/8222	54.8 × 44.1 × 1.7cm	N/A	GRAY, BRN	6

## CUTLERY BINS



### PRODUCT FEATURES:

1. Made of durable commercial grade plastics plus special resin.
2. Ribbed design for added strength and durability.
3. Ideal for storage of dishware or condiment packets.



8231

Model	Description	Dimensions	Capacity	Color	Pack
8231	Cutlery Bin, 4 Compartments	54.0 × 29.2 × 9.5cm	N/A	GRAY	12

## CONDIMENT DISPENSERS



### PRODUCT FEATURES:

1. Convenient and healthy storage of spices and food ingredients.
2. Resistant to scratching due to the textured surface of the transparent cover.
3. The protruding transparent cover edge is easy to open.
4. Smooth surface, easy to clean.



8441



8443

Model	Description	Dimensions	Capacity	Color	Pack
8441	Condiment Dispenser with Three 0.9L Inserts	49.8 × 15.9 × 9.5cm	N/A	BLA	1
8442	Condiment Dispenser with Four 0.7L Inserts	49.8 × 15.9 × 9.5cm	N/A	BLA	1
8443	Condiment Dispenser with Six 0.5L Inserts	49.8 × 15.9 × 9.5cm	N/A	BLA	1

## PITCHERS



### PRODUCT FEATURES:

1. Plastic construction is easy to handle.
2. Lighter than a glass jug, economical and practical.
3. Ergonomic handle, comfortable and easy to use.
4. Complies with NSF #2 inspection standards.

**Note:** 8341, 8342, 8343 and 8344 contain Bisphenol A (BPA).



8262



8263



8264

Model	Description	Dimensions	Capacity	Color	Pack
8261	Pitcher	11.0 × 17.5cm	0.9L	CLR	6
8262	Pitcher	12.5 × 20.0cm	1.4L	CLR	6
8263	Pitcher	13.0 × 20.0cm	1.8L	CLR	6
8264	Pitcher	13.6 × 22.0cm	2.1L	CLR	6
8341	Pitcher	11.0 × 17.5cm	0.9L	CLR	6
8342	Pitcher	12.5 × 20.0cm	1.4L	CLR	6
8343	Pitcher	13.0 × 20.0cm	1.8L	CLR	6
8344	Pitcher	13.6 × 22.0cm	2.1L	CLR	6

## BUDGET POTS



### PRODUCT FEATURES:

1. For drinks such as juice, iced tea and water when dining.
2. Tight fitting lid with three positions - closed, full or half-opened..
3. Wide opening for easy cleaning.
4. Ergonomic handle, comfortable and easy to use.
5. Dishwasher safe.



8265



8266

Model	Description	Dimensions	Capacity	Color	Pack
8265	Cold Water Bottle	N/A	2.0L	CLR	6
8266	Cold Water Bottle	N/A	3.8L	CLR	6



## KID&COOL® YOUTH SEATS



### PRODUCT FEATURES:

1. Designed with safety and cleanliness in mind for your youngest patrons.
2. Complies with ASTM F404-18 and TUV standards.
3. Modern appearance plus ant-microbial technologies allow easier cleaning than wooden seats.
4. Microban® anti-microbial technologies provide full protection and resist odor and stain due to bacteria.
5. Stackable for easy storage.



8011



8013

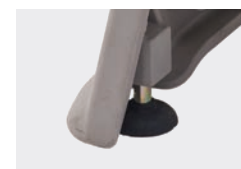

Optional Non-slip Feet Pad Set (8016) can increase the stability of the child seat

## MICROBAN®

### MICROBAN® ANTI-MICROBIAL PROTECTION TECHNOLOGIES

1. Microban® anti-microbial technologies provide full protection by working to destroy or inhibit the growth and reproduction of bacteria, mold and mildew.
2. Microban® anti-microbial ingredients have been added to the baby changing station during its production for permanent protection.



Plastic sample without Microban® anti-microbial ingredients.



Plastic sample with Microban® anti-microbial ingredients.

\*Microban® is the registered owner of Microban® trademark, and reserves all the rights. Microban® anti-microbial protection is not designed to protect users against disease causing micro-organisms and is not a substitute for routine cleaning.

Model	Description	Dimensions	Color	Pack
8011	Kid&Cool® Youth Seat without Wheels	63.6 × 58.3 × 76.8cm	GRN, BLA, BRN, PLAT	1
8012	Kid&Cool® Youth Seat with Wheels	63.6 × 58.3 × 77.3cm	GRN, BLA, BRN, PLAT	1
8013	Tray for 8011/8012/8014	42.4 × 30.0 × 5.5cm	BLUE, GRN, RED, BLA, BRN, PLAT	1
8014	Kid&Cool® Youth Seat RTA (Ready to Assemble) no Wheels	63.6 × 58.3 × 76.8cm	BLUE, GRN, BLA, BRN, PLAT	1
8015	Castor Kit	N/A	N/A	1
8016	Non-slip Feet Pad Set	N/A	BLA	1



## HEIMDALL® BABY CHANGING STATIONS



### PRODUCT FEATURES:

1. Wide table is equipped with adjustable seat belts enhancing safety and reliability.
2. All plastic web structure ensures strength and durability.
3. Two die cast hooks are convenient for hanging accessories.
4. Storage units at the top of the table are convenient to place baby care products.
5. Closed width is only 10.2cm, saving space.
6. Table is equipped with handle, convenient to open.
7. Built-in shelf and liner storage.
8. Microban® antibacterial technology effectively inhibits bacterial growth and odor generation.
9. Meeting the standards of ASTM F2285 and EN 12221-1.



8021



8023



8023

## MICROBAN®

### MICROBAN® ANTI-MICROBIAL PROTECTION TECHNOLOGIES

1. Microban® anti-microbial technologies provide full protection by working to destroy or inhibit the growth and reproduction of bacteria, mold and mildew.
2. Microban® anti-microbial ingredients have been added to the baby changing station during its production for permanent protection.



Plastic sample without Microban® anti-microbial ingredients.

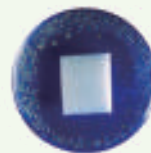

Plastic sample with Microban® anti-microbial ingredients.

\*Microban® is the registered owner of Microban® trademark, and reserves all the rights. Microban® anti-microbial protection is not designed to protect users against disease causing micro-organisms and is not a substitute for routine cleaning.



Two die cast hooks are convenient for hanging accessories. Storage units at the top of the table are convenient for placing baby care products.

Model	Description	Dimensions	Color	Pack
8021	HEIMDALL® Baby Changing Station	Closed: 84.5 × 54.6 × 10.2cm	LPLAT	1
8022	Protective Liners For Baby Changing Station (20 Units)	32.5 × 44.5cm	WHT	16
8023	HEIMDALL® Baby Changing Station	Closed: 58.4 × 86.6 × 10.2cm	LPLAT	1

## KID&COOL® INFANT SAFETY SEATS



### PRODUCT FEATURES:

1. All plastic web structure ensures strength and durability.
2. Strap type safety belt for effective protection.
3. Closed width is only 13.0cm, saving space.
4. Smooth surface for easy cleaning.
5. Microban® antibacterial technology effectively inhibits bacterial growth and odor generation.
6. Meeting the standards of ASTM F2613 and EN 12520.



8031

Model	Description	Dimensions	Color	Pack
8031	KID&COOL® Infant Safety Seat	Closed: 35.5 × 13.0 × 48.6cm	LPLAT	1





## FLOOR SWEEPS

### PRODUCT FEATURES:

1. Designed to clean a variety of surfaces.
2. Plastic body, non-absorbent, and easy to keep clean.
3. PET bristles are strong, durable, and resist grease or water stains.
4. Materials meet FDA requirements.
5. Two threaded handle holes on either side to make bristles wear evenly.



Model	Description	Dimensions	Capacity	Color	Pack
6695	45.0cm Floor Sweep, PET Fill	45.0cm	N/A	BLUE, GRN, RED, YEL, WHT	12
6696	61.0cm Floor Sweep, PET Fill	61.0cm	N/A	BLUE, GRN, RED, YEL, WHT	12

## COUNTER BRUSHES

### PRODUCT FEATURES:

1. Comfortable handle for quick and easy cleaning.
2. PET bristles are strong, durable, and resist grease or water stains.
3. Materials meet FDA requirements.
4. Handle with hang-up hole for easy storage.



Model	Description	Dimensions	Capacity	Color	Pack
6705	Counter Brush, PET Fill	28.5cm	N/A	BLUE, GRN, RED, YEL, WHT	12
6706	Counter Brush, PET Fill	38.5cm	N/A	BLUE, GRN, RED, YEL, WHT	12

## MULTI-PURPOSE BRUSHES



### PRODUCT FEATURES:

1. Versatile, suitable for any catering industry.
2. PET bristles are strong, durable, and resist grease or water stains.
3. Materials meet FDA requirements.
4. Handle with hang-up hole for easy storage.



Model	Description	Dimensions	Capacity	Color	Pack
6714	Short Handle Multi-purpose Cleaning Brush, PET Fill	24.0cm	N/A	BLUE, GRN, RED, YEL, WHT	12
6724	Long Handle Multi-purpose Cleaning Brush, PET Fill	52.0cm	N/A	BLUE, GRN, RED, YEL, WHT	12

## CLEANING BRUSHES



### PRODUCT FEATURES:

1. Versatile, suitable for any catering industries.
2. Durable PP bristles resist wearing or breaking.
3. Ideal for cleaning crevices and corners.
4. Comfortable plastic handles resist splitting or breaking.



Model	Description	Dimensions	Capacity	Color	Pack
6757	Cleaning Brush, PP Fill	12.7cm	N/A	BLUE, GRN, RED, YEL, WHT	12
6758	Cleaning Brush, PP Fill	15.7cm	N/A	BLUE, GRN, RED, YEL, WHT	12
6759	Cleaning Brush, PP Fill	15.7cm	N/A	BLUE, GRN, RED, YEL, WHT	12
6760	Cleaning Brush, PP Fill	21.0cm	N/A	BLUE, GRN, RED, YEL, WHT	12

## CHOPPING BOARD CLEANING BRUSHES



### PRODUCT FEATURES:

1. User friendly handles.
2. Durable PP bristles resist wearing or breaking.
3. Materials meet FDA requirements.
4. Dishwasher safe.



Model	Description	Dimensions	Capacity	Color	Pack
6725	Chopping Board Cleaning Brush, PP Fill	15.0 × 6.4cm	N/A	BLUE, GRN, RED, YEL, WHT, BRN	12
6726	Chopping Board Cleaning Brush, PP Fill	15.0 × 6.4cm	N/A	BLUE, GRN, RED, YEL, WHT, BRN	12

## ANGLE BROOMS



### PRODUCT FEATURES:

1. Block with two handle holes (one straight hole and one angle hole) for two different cleaning purposes.
2. The straight hole for general purpose cleaning. The angle hole is suitable for cleaning of corners and wall-edges.
3. PET bristles are strong, durable, and resist grease or water stains.



6623

Model	Description	Dimensions	Capacity	Color	Pack
6623	Angle Brooms	32.0cm	N/A	BLUE, GRN, RED, YEL, WHT	12

## VEGETABLE CLEANING BRUSHES



### PRODUCT FEATURES:

1. 6611 suitable for cleaning of white and red potatoes.
2. 5691 has a round enclosed structure, suitable for washing vegetables from all directions.
3. 5692 has an oval enclosed structure suitable for a variety of cleaning in the kitchen.
4. Comfortable plastic handle is easy to use.
5. Materials meet FDA requirements.
6. Handle with hang-up hole for easy storage.



6611



5691

Model	Description	Dimensions	Capacity	Color	Pack
6611	Potato Cleaning Brush	12.0 × 5.1 × 4.0cm	N/A	WHT	12
5691	Round Vegetable Cleaning Brush	24.5cm	N/A	WHT	12
5692	Oval Multipurpose Cleaning Brush	22.2cm	N/A	WHT	12

## BOTTLE CLEANING BRUSHES

### PRODUCT FEATURES:

1. Designed to clean the neck and other hard-to-reach part of bottles, jars, kettles and cups.
2. Comfortable plastic handle is easy to use.
3. Materials meet FDA requirements.
4. Handle with hang-up hole for easy storage.



5701

Model	Description	Dimensions	Capacity	Color	Pack
5701	Bottle Cleaning Brush	38.0cm	N/A	WHT	12
5702	Bottle Cleaning Brush	65.0cm	N/A	WHT	12



## PIPE CLEANING BRUSHES

### PRODUCT FEATURES:

1. Designed to clean the nozzle of various containers and funnels.
2. Nylon bristles.
3. Materials meet FDA requirements.



Model	Description	Dimensions	Capacity	Color	Pack
5721	0.6cm Pipe Cleaning Brush	16.5cm	N/A	WHT	12
5722	1.0cm Pipe Cleaning Brush	20.3cm	N/A	WHT	12
5723	1.9-3.8cm Pipe Cleaning Brush	25.4cm	N/A	WHT	12
5724	1.3-2.5cm Pipe Cleaning Brush	30.5cm	N/A	WHT	12

## HIGH-TEMPERATURE CLEANING BRUSHES

### PRODUCT FEATURES:

1. Designed to clean high-temperature equipment.
2. High-temperature resistant bristles can resist temperatures up to 260°C.
3. Enables cleaning of equipment that is still hot, saving time.
4. Holes on the tailend of handle are available for hanging and storage.
5. 5731 is fit for for cleaning in tight spaces.
6. 5732 and 5733 have an L-shaped end for quick cleaning of coiled equipment.
7. 5734 has a loop-end, fit for cleaning the bottom of devices.

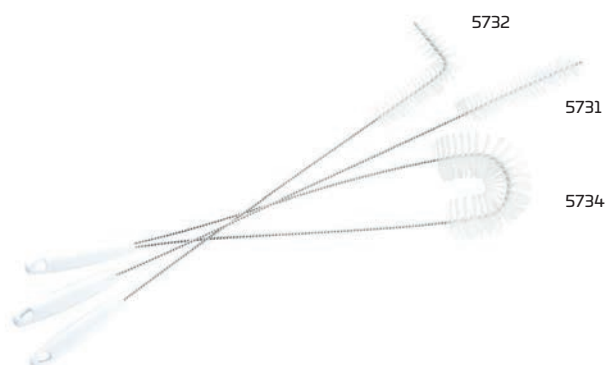

Model	Description	Dimensions	Capacity	Color	Pack
5731	3.5cm High Temperature Cleaning Brush	71.0cm	N/A	WHT	12
5732	2.2cm L-shaped High-temperature Cleaning Brush	54.0cm	N/A	WHT	12
5733	5.0cm L-shaped High-temperature Cleaning Brush	58.0cm	N/A	WHT	12
5734	5.0cm Ring-shaped High-temperature Cleaning Brush	61.0cm	N/A	WHT	6

## COFFEE MACHINE CLEANING BRUSHES

### PRODUCT FEATURES:

1. Designed to clean coffee machines and glass coffee bottles.
2. Semi-circular shape is suitable for cleaning the internal surface of coffee machines.
3. A hole on the tail end of the handle is for hanging and storage.

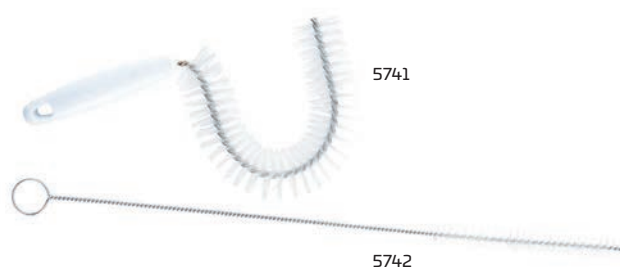

Model	Description	Dimensions	Capacity	Color	Pack
5741	3.8cm Semicircular Coffee Machine Cleaning Brush	25.4cm	N/A	WHT	12
5742	1.6cm Coffee Machine Cleaning Brush	63.5cm	N/A	WHT	12

## GLASS BRUSHES

### PRODUCT FEATURES:

1. Designed for cleaning glasses.
2. Plastic construction helps prevent glasses from being chipped or broken.
3. Molded plastic base with positive-suction provide a tight grip in sinks and on countertops.



6727



6728

Model	Description	Dimensions	Capacity	Color	Pack
6727	Three Heads Glass Brush	35.0 × 10.5 × 20.0cm	N/A	BLA	6
6728	Two Heads Glass Brush	20.0 × 9.0 × 20.0cm	N/A	BLA	6
6729	Standard Glass Brush Head	Dia 7.5 × 19.5cm	N/A	BLA	12

## PROFESSIONAL PLASTIC SQUEEGEES



### PRODUCT FEATURES:

1. Pre-treated polypropylene resists corrosion.
2. Twin black porous foam blades.
3. For removing liquids, moderate dirt.
4. Rubber resists oils, greases and most chemicals.
5. Fits 6351 broom handle which is sold separately.



6831

Model	Description	Dimensions	Capacity	Color	Pack
6831	Plastic Professional Squeegee with Black Dual Moss Rubber	45.7 × 5.8 × 8.9cm	N/A	BLUE, GRN, RED, YEL	10



## U-RAG® SUPERFINE FIBER CLOTHS



### PRODUCT FEATURES:

1. Superfine fiber cloth offers optimized cleaning performance.
2. Rinsable and reusable, resist wash up to 40 times.
3. Bleach cleaning safe.
4. 30% higher decontamination capabilities than a cotton rag.
5. Removes more than 99.9% of bacteria and dirt.
6. Reduces the use of chemical cleansers.
7. Extends service life, reduces the use of paper towels.



6481/6482/6483/6484

Model	Description	Dimensions	Capacity	Color	Pack
6481	U-RAG® Superfine Fiber Cloth	48.3 × 40.6cm	N/A	RED	144
6482	U-RAG® Superfine Fiber Cloth	48.3 × 40.6cm	N/A	YEL	144
6483	U-RAG® Superfine Fiber Cloth	48.3 × 40.6cm	N/A	BLUE	144
6484	U-RAG® Superfine Fiber Cloth	48.3 × 40.6cm	N/A	GRN	144

## CLEANING TOOL HOLDERS



### PRODUCT FEATURES:

1. Helps increase productivity and efficiency through better tool storage and access.
2. S-hooks hold 1.6cm to 3.2cm handle diameters.
3. Special hooks afford easy accessibility.
4. Includes a clip for holding record books.
5. 25113, 25114 and 25115 aluminum alloy material, light and never rusty. Used with stuck clips, hooks and signboards.
6. 25116 is suitable for fixing handles with a diameter of 22-32mm.
7. 25117 is suitable for fixing handles with a diameter of 28-38mm.
8. 25118 is suitable for fixing cleaning tools with hanging holes.
9. 25119 can be used with the base of the aluminum alloy tool rack, which can identify the hanging tools at each position clearly.



6942



6941



25114/25117/25116/25118/25119



Model	Description	Dimensions	Capacity	Color	Pack
6941	Closet Organizer/Tool Holder Kit	45.7 × 8.3 × 10.8cm	N/A	BLUE, GRN, RED, YEL	6
6942	Closet Organizer/Tool Holder Kit	86.4 × 8.3 × 10.8cm	N/A	BLUE, GRN, RED, YEL	4
25113	HEDGEHOG® Cleaning Tool Rack Base, 300mm	30.0 × 5.0 × 1.0cm	N/A	BLUE, VGRN, RED, GLD	12
25114	HEDGEHOG® Cleaning Tool Rack Base, 500mm	50.0 × 5.0 × 1.0cm	N/A	BLUE, VGRN, RED, GLD	12
25115	HEDGEHOG® Cleaning Tool Rack Base, 900mm	90.0 × 5.0 × 1.0cm	N/A	BLUE, VGRN, RED, GLD	12
25116	HEDGEHOG® Small Stuck Clip	8.0 × 8.0 × 3.6cm	N/A	BLUE, VGRN, RED, GLD	12
25117	HEDGEHOG® Large Stuck Clip	8.5 × 8.0 × 3.6cm	N/A	BLUE, VGRN, RED, GLD	12
25118	HEDGEHOG® Hook	4.0 × 4.4 × 3.3cm	N/A	BLUE, VGRN, RED, GLD	12
25119	HEDGEHOG® Signboard	11.2 × 12.5 × 0.9cm	N/A	BLUE, VGRN, RED, GLD	12



**SAFETY SIGNS**

Floor Safety Signs	268
Four-sided Billboards	268
Stable Safety Signs	269
Hanging Safety Signs	269
Site Safety Hanging Signs	269

**SAFETY CONES AND ACCESSORIES**

Movable Fences	270
Safety Cones	271
Pop-up Safety Cones	272
Folding Safety Cones	272



## Keep Your Workplace Safe

TRUST has multiple solutions to ensure safety at your workplace.

## Innovative Design

TRUST provides you with products for various purposes to meet your safety requirements in different workplaces.





## FLOOR SAFETY SIGNS

### PRODUCT FEATURES:

1. Lightweight and versatile; draws clear attention to a safety issue.
2. Folding design for convenient storage and to minimize space.
3. Built-in hook for hanging a weight.
4. Custom imprint for various sites.
5. Allows for hanging on Cleaning Cart (5011) or All-in-one Bucket (5211).
6. Custom print available by contacting your local dealer.



7114



Model	Description	Dimensions	Capacity	Color	Pack
7114	Floor Safety Sign with "Caution Wet Floor" Imprint	66.0 × 27.9 × 30.5cm	N/A	YEL	6
7161	Floor Safety Sign with "Repair in Progress" Imprint	66.0 × 27.9 × 30.5cm	N/A	YEL	6
7162	Floor Safety Sign with "Cleaning in Progress" Imprint	66.0 × 27.9 × 30.5cm	N/A	YEL	6
7163	Floor Safety Sign with "Out of Service" Imprint	66.0 × 27.9 × 30.5cm	N/A	YEL	6

## FOUR-SIDED BILLBOARDS

### PRODUCT FEATURES:

1. Folding design for convenient storage and to minimize space.
2. Innovative four-sided design can increase the stability of product.
3. Four-sided design improves safety with increased visibility from all directions.
4. Custom printing available, please contact your local dealer.



7176



7177



7178



Model	Description	Dimensions	Capacity	Color	Pack
7175	Four-sided Billboard - Caution Wet Floor	40.0 × 30.0 × 90.0cm	N/A	YEL	6
7176	Four-sided Billboard - Cleaning in Progress	40.0 × 30.0 × 90.0cm	N/A	YEL	6
7177	Four-sided Billboard - Out of Service	40.0 × 30.0 × 90.0cm	N/A	YEL	6
7178	Four-sided Billboard - Repair in Progress	40.0 × 30.0 × 90.0cm	N/A	YEL	6



## STABLE SAFETY SIGNS

### PRODUCT FEATURES:

1. Unique “No-tip” design and bold graphics quickly capture pedestrian’s attention.
2. Designed for convenient storage - transport on on Cleaning Cart (5011) or Rim Caddy (1821).
3. Large warning triangle with bold graphics.
4. Only 3.8cm thick when stored.
5. Self-opening feet give sign a large, stable base.
6. Low center of gravity helps prevent tipping when bumped, kicked or wind blown.
7. Custom printing available, please contact your local dealer.



7133

Model	Description	Dimensions	Capacity	Color	Pack
7133	Stable Safety Sign with “Caution Wet Floor” Imprint	Open: 66.0 × 33.0 × 33.6cm Closed: 82.0 × 33.0 × 3.8cm	N/A	YEL	6

## HANGING SAFETY SIGNS



### PRODUCT FEATURES:

1. Flexible locking hanger keeps sign in place.
2. Two-sided fluorescent yellow design.



7142



Model	Description	Dimensions	Capacity	Color	Pack
7142	Hanging Safety Sign with “Caution Wet Floor” Imprint	49.5 × 11.1 × 5.5cm	N/A	YEL	6

## SITE SAFETY HANGING SIGNS



### PRODUCT FEATURES:

1. Twisting action secures pole in doorways up to 127cm wide to prevent entry.
2. Soft, pliable sign rolls up on pole for easy storage.



7152

Model	Description	Dimensions	Capacity	Color	Pack
7152	Site Safety Hanging Sign with “Closed for Cleaning” Imprint	Closed: 33.0 × 63.5 × 2.5cm Open: 33.0 × 127.0 × 2.5cm	N/A	YEL	6

# SAFETY CONES AND ACCESSORIES



## MOVABLE FENCES

### PRODUCT FEATURES:

1. Movable fences for easy use, movement and storage.
2. For indoor use, flexible panels allow straight, curved, and circular configurations.
3. After folding, the thickness of the fence is 18.4-34.9cm, provides easy storage, saving space.
4. The fence is equipped with two 12.5cm non-marking castors for efficient and ergonomic movement.
5. Highly visible mobile barrier for use in many situations.
6. Shipped assembled.



7182

7181

Model	Description	Dimensions	Capacity	Color	Pack
7181	Movable Fence, Consisting of 16 Connecting Plates	Close: 34.9 × 60.0 × 100.0cm Open: 398.0 × 60.0 × 100.0cm	N/A	YEL	1
7182	Movable Fence, Consisting of 12 Connecting Plates	Close: 26.6 × 60.0 × 100.0cm Open: 278.0 × 60.0 × 100.0cm	N/A	YEL	1
7183	Movable Fence, Consisting of 8 Connecting Plates	Close: 18.4 × 60.0 × 100.0cm Open: 158.0 × 60.0 × 100.0cm	N/A	YEL	1



# SAFETY CONES

## PRODUCT FEATURES:

1. Highly visible bright fluorescent yellow.
2. Versatile top design accommodates barricade belt, flashing light or a lock-in sign holder.
3. Slots across two opposing sides are designed for a barrier chain.
4. Four sided shape allows for efficient stacking.
5. Imprinting on four sides allows for a safety or alert message from all directions.
6. Custom messages to be printed on different environment.
7. 7323 matched with 1812 for easy transit.
8. 7323 matched with 7521 for enhanced stability.



Model	Description	Dimensions	Capacity	Color	Pack
7313	Safety Cone with "Caution, Wet Floor" Imprint	26.7 × 26.7 × 65.4cm	N/A	YEL	6
7315	Safety Cone with "No Parking" Imprint	26.7 × 26.7 × 65.4cm	N/A	YEL	6
7323	Safety Cone with "Caution, Wet Floor" Imprint	31.1 × 31.1 × 91.4cm	N/A	YEL	5
1812	THOR® Square Dolly	43.8 × 15.9cm	N/A	BLA	2
7121	Safety Cone Signs	29.6 × 26.2 × 5.5cm	N/A	RED	5
7122	Safety Cone Signs with "No Parking" Imprint	29.6 × 26.2 × 5.5cm	N/A	RED	5
7511	Barrier Chain	2.2 × 2.2 × 610.0cm	N/A	YEL	4
7512	Safety Warning Light	8.6 × 13.5cm	N/A	YEL	12
7521	Weight Ring-Single for 7323	31.8 × 31.8 × 8.0cm	N/A	BLA	1





## POP-UP SAFETY CONES

### PRODUCT FEATURES:

1. Convenient, quick deployment when hazard arises.
2. Collapsible, automatically deployed cone.
3. Wall-mounted, shatter proof, storage tube allows for easily and compact storing.
4. Durable material withstands abuse.
5. Storage tube mounting hardware includes tape and screws.



7333

Model	Description	Dimensions	Capacity	Color	Pack
7333	Pop-Up Safety Cone, 50cm with "Caution, Wet Floor" Imprint	Dia 53.3 x 50.8cm Shell: 74 x 6.0 x 57.0cm	N/A	YEL	12
7334	Pop-Up Safety Cone, 76cm with "Caution, Wet Floor" Imprint	Dia 53.3 x 76.2cm Shell: 74 x 6.0 x 82.2cm	N/A	YEL	12

## FOLDING SAFETY CONES



### PRODUCT FEATURES:

1. Space-saving storage container can be installed flat against the wall.
2. Folds easily and quickly after use.
3. Can be hung on the handle of Bucket Wringer (5226) with the compatible ring.
4. Made of spring steel and cleanable fabric.
5. Area is 51 x 46cm when opened; only 22.8cm diameter when folded.



7342



Model	Description	Dimensions	Capacity	Color	Pack
7342	Folding Safety Cone with "Caution, Wet Floor" Imprint	Open: 50.8 x 46.6 x 33.0cm Close: 20.3 x 20.3 x 3.8cm Shell: 20.3 x 22.2 x 4.4cm	N/A	YEL	12



# PRODUCT INDEX

No.	Product Name	Pack	Color	Order Code	Color	Order Code	Page
1009	Thor® Round Container	6	GRAY	610098881	GRN	610098884	10
			WHT	610098882	RED	610098885	
			YEL	610098883	BLUE	610098886	
			BRN	610098887			
1010	Thor® Round Container	6	GRAY	610108881	GRN	610108884	10
			WHT	610108882	RED	610108885	
			YEL	610108883	BLUE	610108886	
1011	Thor® Round Container	6	GRAY	610118881	GRN	610118884	10
			WHT	610118882	RED	610118885	
			YEL	610118883	BLUE	610118886	
			BRN	610118887			
1012	Thor® Round Container	6	GRAY	610128881	RED	610128885	10
			WHT	610128882	BLUE	610128886	
			YEL	610128883	BRN	610128887	
			GRN	610128884	BLA	61012888A	
1013	Thor® Round Container	6	GRAY	610138881	RED	610138885	10, 36
			WHT	610138882	BLUE	610138886	
			YEL	610138883	BLA	610138887	
			GRN	610138884	BRN	610138888	
			LGRAY	610138889			
1014	Thor® Round Container	4	GRAY	610148881	RED	610148885	10, 60, 79
			WHT	610148882	BLUE	610148886	
			YEL	610148883	BLA	610148887	
			GRN	610148884			
1015	Thor® Round Container	3	GRAY	610158881	RED	610158885	10
			WHT	610158882	BLA	610158886	
			YEL	610158883	BLUE	610158887	
			GRN	610158884			
1016	Thor® Round Container	6	BLUE	610168881			29
1017	Thor® Round Container	6	BLUE	610178881			29
1018	Thor® Round Container	4	BLUE	610188881			29
1019	Round Case, with a Top	6	YEL	610198882	RED	610198883	41
1020	Round Case, with a Top	6	YEL	610208882	RED	610208883	41
1021	Thor® Rollout Container	2	GRAY	610218881	RED	610218884	12
			YEL	610218882	GRN	610218885	
			BLUE	610218883			
1022	Thor® Rollout Recycling Trash Bin with Cover	2	BLUE	610228881			37
1025	Thor® Rollout Container	1	GRAY	610258881	RED	610258882	12
1026	Thor® Rollout Recycling Bin, Rotomolded	1	BLUE	610268881			37
1031	Thor® Rollout Container	2	GRAY	610318881	BLUE	610318884	13
			RED	610318882	GRN	610318885	
			YEL	610318883	BLA	610318886	
1032	Thor® Rollout Container	2	GRAY	610328881	BLUE	610328884	13
			RED	610328882	GRN	610328885	
			YEL	610328883	BLA	610328886	
1033	Thor® Rollout Container	1	GRAY	610338881	BLUE	610338884	13
			RED	610338882	GRN	610338885	
			YEL	610338883	BLA	610338886	
1034	Thor® Rollout Container	1	GRAY	610348881	BLUE	610348884	13
			RED	610348882	GRN	610348885	
			YEL	610348883	BLA	610348886	
1035	Thor® Step-On Rollout Container	1	GRAY	610358881	BLUE	610358884	14, 24
			RED	610358882	GRN	610358885	
			YEL	610358883	BLA	610358886	
1036	Thor® Step-On Rollout Container	1	GRAY	610368881	BLUE	610368884	14, 24
			RED	610368882	GRN	610368885	
			YEL	610368883	BLA	610368886	
1037	Thor® Step-On Rollout Container	1	GRAY	610378881	BLUE	610378884	14, 24
			RED	610378882	GRN	610378885	
			YEL	610378883	BLA	610378886	
1038	Thor® Step-On Rollout Container	1	GRAY	610388881	BLUE	610388884	14, 24
			RED	610388882	GRN	610388885	
			YEL	610388883	BLA	610388886	

No.	Product Name	Pack	Color	Order Code	Color	Order Code	Page
1041	Thor® Rollout Container with Castors	2	GRAY	610418881	BLUE	610418884	13
			RED	610418882	GRN	610418885	
			YEL	610418883	BLA	610418886	
1042	Thor® Rollout Container with Castors	2	GRAY	610428881	BLUE	610428884	13
			RED	610428882	GRN	610428885	
			YEL	610428883	BLA	610428886	
1043	Thor® Rollout Container with Castors	1	GRAY	610438881	BLUE	610438884	13
			RED	610438882	GRN	610438885	
			YEL	610438883	BLA	610438886	
1044	Thor® Rollout Container with Castors	1	GRAY	610448881	BLUE	610448884	13
			RED	610448882	GRN	610448885	
			YEL	610448883	BLA	610448886	
1045	Thor® Step-On Rollout Container with Castors	1	GRAY	610458881	BLUE	610458884	14, 24
			RED	610458882	GRN	610458885	
			YEL	610458883	BLA	610458886	
1046	Thor® Step-On Rollout Container with Castors	1	GRAY	610468881	BLUE	610468884	14, 24
			RED	610468882	GRN	610468885	
			YEL	610468883	BLA	610468886	
1047	Thor® Step-On Rollout Container with Castors	1	GRAY	610478881	BLUE	610478884	14, 24
			RED	610478882	GRN	610478885	
			YEL	610478883	BLA	610478886	
1048	Thor® Step-On Rollout Container with Castors	1	GRAY	610488881	BLUE	610488884	14, 24
			RED	610488882	GRN	610488885	
			YEL	610488883	BLA	610488886	
1211	Svelte® Slim Rectangle Container	4	GRAY	612118881	BLUE	612118883	18, 31, 32, 73
			GRN	612118882	BEIG	612118884	
			BRN	612118885	BLA	612118886	
			LGRAY	612118887	RED	612118888	
			YEL	612118889			
1212	Svelte® Slim Rectangle Recycling Container	4	BLUE	612128881	GRN	612128882	30
1213	Svelte® Slim Rectangle Container	4	BEIG	612138881	BLUE	612138884	18, 31, 32, 62, 71, 73, 78
			BRN	612138882	GRN	612138885	
			GRAY	612138883	BLA	612138886	
			LGRAY	612138887	RED	612138888	
			YEL	612138889			
1214	Svelte® Slim Rectangle Recycling Container	4	BLUE	612148881	GRN	612148882	30
1215	Svelte® Slim Rectangle Container	4	GRAY	612158881	BEIG	612158884	16, 33, 34, 71
			BLUE	612158882	BRN	612158885	
			GRN	612158883	BLA	612158886	
			LGRAY	612158887	RED	612158888	
			YEL	612158889			
1216	Castor Set for 1215	1	BLA	612168881			16
1217	Svelte® Recycling Container	4	BLUE	612178881	GRN	612178882	30
1218	Garbage Classification Fixing Device for 1212/1214	1	BLA	612188881			30
1219	Classification Collection Lid for 1641	4	RED	612198881	BLUE	612198883	30
			YEL	612198882	GRN	612198884	
1220	Svelte® Container	4	BLA	612208881	GRAY	612208885	18, 31, 32, 62, 78
			BEIG	612208882	BLUE	612208886	
			BRN	612208883	GRN	612208887	
			RED	612208884	YEL	612208888	
			LGRAY	612208889			
1221	Svelte® Recycling Container	4	BLUE	612218881	GRN	612218882	30
1223	Half-round Container	4	BEIG	612238881	GRAY	612238882	25
1224	Half-round Recycling Container	4	BLUE	612248881			30
1231	Square Container	6	GRAY	612318881	RED	612318883	12, 187
			WHT	612318882			
1233	Square Container	4	GRAY	612338881	WHT	612338882	12, 187
1234	Square Recycling Container	4	BLUE	612348881			29
1235	Square Case, with a Top	6	YEL	612358882	RED	612358883	41
1236	Square Case, with a Top	4	YEL	612368882	RED	612368883	41
1241	Side Bin Recycling Center	12	GRAY	612418881	GRN	612418883	26, 38
			BLA	612418882	BLUE	612418884	
1242	Wastebasket, Small	12	BLA	612428881	BEIG	612428883	26
			GRAY	612428882			

# PRODUCT INDEX

No.	Product Name	Pack	Color	Order Code	Color	Order Code	Page
1243	Wastebasket, Medium	12	BLA	612438881	BLUE	612438884	26
			GRAY	612438882	GRN	612438885	
			BEIG	612438883			
1244	Wastebasket, Large	12	BLA	612448881	BLUE	612448884	26
			GRAY	612448882	GRN	612448885	
			BEIG	612448883			
1245	Wastebasket, Large	12	BLA	612458881	BLUE	612458884	26
			GRAY	612458882	GRN	612458885	
			BEIG	612458883			
1246	Deskside Recycling Container, Small	12	BLUE	612468881	GRN	612468882	38
1247	Deskside Recycling Container, Medium	12	BLUE	612478881	GRN	612478882	38
1248	Deskside Recycling Container, Large	12	BLUE	612488881			38
1249	Deskside Recycling Container, Large	12	BLUE	612498881			38
1250	Step-on Container	1	YEL	612508882	RED	612508883	41
1251	Step-on Container	1	WHT	612518881	BEIG	612518883	21
			RED	612518882	YEL	612518884	
			BLUE	612518885			
1252	Step-on Container	1	WHT	612528881	BEIG	612528883	21
			RED	612528882	YEL	612528884	
			BLUE	612528885			
1253	Step-on Container	1	WHT	612538881	BEIG	612538883	21
			RED	612538882	YEL	612538884	
			BLUE	612538885			
1254	Step-on Container	1	WHT	612548881	BEIG	612548883	21
			RED	612548882	YEL	612548884	
			BLUE	612548885			
1255	Rollout Step-on Container	1	WHT	612558881	BEIG	612558883	21
			RED	612558882	YEL	612558884	
			BLUE	612558885			
1256	Step-on Container	1	YEL	612568882	RED	612568883	41
1257	Step-on Container	1	YEL	612578882	RED	612578883	41
1258	Step-on Container	1	YEL	612588882	RED	612588883	41
1259	Rollout Step-on Container	1	YEL	612598882	RED	612598883	41
1261	UNIFIRE® Fire-resistant Wastebasket	6	BEIG	612618881	BLA	612618882	26
1262	UNIFIRE® Fire-resistant Wastebasket	6	GRAY	612628881	BEIG	612628883	26
			BLA	612628882			
1263	UNIFIRE® Fire-resistant Wastebasket	6	GRAY	612638881	BEIG	612638883	26
			BLA	612638882			
1264	UNIFIRE® Fire-resistant Wastebasket	4	BEIG	612648881			26
1271	Square Container	4	GRAY	612718881	BRN	612718883	25, 35
			BLA	612718882	BEIG	612718884	
			LGRAY	612718885			
1281	Square Container	4	GRAY	612818881	BRN	612818883	25, 52
			BLA	612818882	BEIG	612818884	
1282	Square Container	4	GRAY	612828881	BEIG	612828882	25, 38, 52
1283	Square Container	4	GRAY	612838881	BEIG	612838882	25
1284	Square Container	4	GRAY	612848881			25, 52
1291	Round Wastebasket	6	MSILV	612918881	BLA	612918882	27
1292	Square Wastebasket	3	MSILV	612928881			27
1293	Rectangular Wastebasket	3	BLA	612938881			27
1301	Svelte® Step-on Container	1	BEIG	613018881	YEL	613018885	23
			WHT	613018882	BLUE	613018886	
			GRAY	613018883	GRN	613018887	
			RED	613018884	BLA	613018888	
1302	Svelte® Step-on Container	1	BEIG	613028881	YEL	613028885	23
			WHT	613028882	BLUE	613028886	
			GRAY	613028883	GRN	613028887	
			RED	613028884	BLA	613028888	
1303	Svelte® Step-on Container	1	BEIG	613038881	YEL	613038885	23
			WHT	613038882	BLUE	613038886	
			GRAY	613038883	GRN	613038887	
			RED	613038884	BLA	613038888	

No.	Product Name	Pack	Color	Order Code	Color	Order Code	Page
1304	Svelte® Step-on Container	1	BEIG	613048881	YEL	613048885	23
			WHT	613048882	BLUE	613048886	
			GRAY	613048883	GRN	613048887	
			RED	613048884	BLA	613048888	
1305	Svelte® Step-on Container	1	BEIG	613058881	YEL	613058885	22
			WHT	613058882	BLUE	613058886	
			GRAY	613058883	GRN	613058887	
			RED	613058884	BLA	613058888	
1306	Svelte® Step-on Container	1	BEIG	613068881	YEL	613068885	22
			WHT	613068882	BLUE	613068886	
			GRAY	613068883	GRN	613068887	
			RED	613068884	BLA	613068888	
1307	Svelte® Step-on Container	1	BEIG	613078881	YEL	613078885	22
			WHT	613078882	BLUE	613078886	
			GRAY	613078883	GRN	613078887	
			RED	613078884	BLA	613078888	
1308	Svelte® Step-on Container	1	BEIG	613088881	YEL	613088885	22
			WHT	613088882	BLUE	613088886	
			GRAY	613088883	GRN	613088887	
			RED	613088884	BLA	613088888	
1309	Svelte® Step-on Container	1	BEIG	613098881	YEL	613098885	22
			WHT	613098882	BLUE	613098886	
			GRAY	613098883	GRN	613098887	
			RED	613098884	BLA	613098888	
1310	Round Stainless Steel Step-on Container	1	SSS	613108881			48
1311	Round Stainless Steel Step-on Container	1	SSS	613118881			48
1312	Round Stainless Steel Step-on Container	1	SSS	613128881			48
1313	Round Stainless Steel Step-on Container	1	SSS	613138881			48
1314	Svelte® Stainless Steel Step-on Container	1	SSS	613148881			50
1315	Svelte® Stainless Steel Step-on Container	1	SSS	613158881			50
1316	Svelte® Stainless Steel Step-on Container	1	SSS	613168881			50
1317	Svelte® Stainless Steel Step-on Container	1	SSS	613178881			50
1318	Domed Open Trash Can	1	BLA	613188881			48
1319	Top Open Trash Can	1	SS	613198881			48
1320	Semicircular Stainless Steel Step-on Trash Can	1	SSS	613208881			50
1321	Semicircular Stainless Steel Step-on Trash Can	1	SSS	613218881			50
1322	Round Stainless Steel Step-on Container	1	SSS	613228881			49
1323	Round Stainless Steel Step-on Container	1	SSS	613238881			49
1324	Round Stainless Steel Step-on Container	1	SSS	613248881			49
1325	Round Stainless Steel Step-on Container	1	SSS	613258881			49
1326	Round Stainless Steel Step-on Container	1	SSS	613268881			49
1327	Round Stainless Steel Step-on Container	1	SSS	613278881			49
1411	Rigid Liner for 1251	2	GRAY	614118881			21
1412	Rigid Liner for 1252	2	GRAY	614128881			21
1413	Rigid Liner for 1253	2	GRAY	614138881			21
1414	Rigid Liner for 1254	4	GRAY	614148881			21
1415	Rigid Liner for 1255	4	GRAY	614158881			21
1421	Rigid Liner for 1301	2	BLA	614218881			23
1422	Rigid Liner for 1302	2	BLA	614228881			23
1423	Rigid Liner for 1303	2	BLA	614238881			23
1424	Rigid Liner for 1304	2	BLA	614248881			23
1425	Rigid Liner for 1305	2	BLA	614258881			22
1426	Rigid Liner for 1306	2	BLA	614268881			22
1427	Rigid Liner for 1307	2	BLA	614278881			22
1428	Rigid Liner for 1308	2	BLA	614288881			22
1429	Rigid Liner for 1309	2	BLA	614298881			22
1609	Thor® Lid for 1009	6	GRAY	616098881	GRN	616098884	11
			WHT	616098882	RED	616098885	
			YEL	616098883	BLUE	616098886	
			BLA	616098887	BRN	616098889	
1610	Thor® Lid for 1010	6	GRAY	616108881	GRN	616108884	11
			WHT	616108882	RED	616108885	
			YEL	616108883	BLUE	616108886	

# PRODUCT INDEX

No.	Product Name	Pack	Color	Order Code	Color	Order Code	Page
1611	Thor® Lid for 1011	6	GRAY	616118881	GRN	616118884	11
			RED	616118882	WHT	616118885	
			YEL	616118883	BLUE	616118886	
			BRN	616118887	BLA	616118888	
1612	Thor® Lid for 1012	6	GRAY	616128881	GRN	616128885	11
			WHT	616128882	RED	616128886	
			YEL	616128883	BLA	616128887	
			BLUE	616128884	BRN	616128888	
1613	Thor® Lid for 1013	6	GRAY	616138881	GRN	616138884	11
			WHT	616138882	BLA	616138885	
			YEL	616138883	BLUE	616138886	
			RED	616138887	BRN	616138888	
1614	Thor® Lid for 1014	4	GRAY	616148881	GRN	616148884	11
			WHT	616148882	BLA	616148885	
			YEL	616148883	BLUE	616148886	
			RED	616148887			
1615	Thor® Lid for 1015	3	GRAY	616158881			11
1621	Thor® Funnel Top for 1011	6	GRAY	616218881	BLUE	616218882	10
			GRN	616218883			
1622	Thor® Funnel Top for 1012	6	GRAY	616228881	BLUE	616228882	10, 29
			GRN	616228883			
1623	Thor® Funnel Top for 1013	4	GRAY	616238881	BLUE	616238882	10, 29
			GRN	616238883			
1633	Thor® Lid for 1013	1	GRAY	616338881	RED	616338882	11
1634	Thor® Round Top with an ashtray for 1013	1	GRAY	616348881	RED	616348882	11
1635	Thor® Bottle and Can Recycling Top for 1013	6	BLUE	616358881	GRN	616358882	11, 29
1636	Thor® Paper Recycling Top for 1013	6	BLUE	616368881	GRN	616368882	11, 29
1637	Thor® Single Stream Recycling Top for 1013	6	BLUE	616378881	GRN	616378882	11, 29
1641	Bottle and Can Recycling Top	4	BLUE	616418881	GRN	616418882	18, 30
			RED	616418883	YEL	616418884	
			BRN	616418885	BLA	616418886	
			GRAY	616418887			
1642	Paper Recycling Top	4	BLUE	616428881	RED	616428882	18, 30
			GRN	616428883			
1643	Handle Top	4	LGRAY	616438881			18
1644	Swing Lid	4	GRAY	616448881	BLUE	616448883	18
			BLA	616448882	BEIG	616448884	
			GRN	616448885			
1645	Connect Valve Style Lid	4	BLA	616458881			18, 71, 73
1646	Single Stream Recycling Top	4	GRN	616468881			18, 30
1647	Svelte® Bottle and Can Recycling Top for 1215	4	BLUE	616478881	GRN	616478882	17, 30
1648	Svelte® Paper Recycling Top for 1215	4	BLUE	616488881			17, 30
1649	Svelte® Handle Top for 1215	4	LGRAY	616498881			17
1650	Svelte® Swing Lid for 1215	4	GRAY	616508881	BEIG	616508884	17
			BLA	616508882	GRN	616508885	
			BLUE	616508883			
1651	Svelte® Lockable Lid for 1215	4	BLA	616518881	BLUE	616518883	17
			GRAY	616518882	GRN	616518884	
			BEIG	616518885			
1653	Half-round Top for 1223	4	BLA	616538881	GRAY	616538882	25
			BEIG	616538883			
1661	Thor® Lid for 1231	6	GRAY	616618881	WHT	616618883	12, 187
			RED	616618882			
1663	Thor® Lid for 1233	4	GRAY	616638881	WHT	616638882	12, 187
1672	Hand-free Top for 1242	6	BLA	616728881	BEIG	616728882	26
			GRAY	616728883			
1673	Hand-free Top for 1243	6	BLA	616738881	BEIG	616738882	26
			GRAY	616738883			
1674	Hand-free Top for 1244	6	BLA	616748881	BEIG	616748882	26
			GRAY	616748883			
1681	Square Top for 1271	4	GRAY	616818881	BEIG	616818883	25
1682	Bottle/Tin Recycling Top for 1271	4	BLUE	616828881	GRN	616828882	25
			RED	616828883			
1683	Paper Recycling Top for 1271	4	BLUE	616838881	GRN	616838882	25
1684	Bottle/Tin Recycling Top for 1282	4	BLUE	616848881	GRN	616848882	25

No.	Product Name	Pack	Color	Order Code	Color	Order Code	Page
1685	Paper Recycling Top for 1282	4	BLUE	616858881	GRN	616858882	25
1700	Lid for 1211/1213	4	LGRAY	617008881			31
1701	Paper Recycling Top for 1700	4	GRAY	617018881	BLUE	617018884	31
			RED	617018882	GRN	617018885	
			YEL	617018883	BLA	617018886	
			BRN	617018887			
1702	Bottle and Can Recycling Top for 1700	4	GRAY	617028881	BLUE	617028884	31
			RED	617028882	GRN	617028885	
			YEL	617028883	BLA	617028886	
			BRN	617028887			
1703	Paper/Bottle Recycling Top for 1700	4	GRAY	617038881	BLUE	617038884	31
			RED	617038882	GRN	617038885	
			YEL	617038883	BLA	617038886	
			BRN	617038887			
1704	Enclosed Lid for 1700	4	GRAY	617048881	BLUE	617048884	31
			RED	617048882	GRN	617048885	
			YEL	617048883	BLA	617048886	
			BRN	617048887			
1710	Top for 1211/1213	4	LGRAY	617108881			32
1711	Paper Recycling Top for 1710	4	GRAY	617118881	BLUE	617118884	32
			RED	617118882	GRN	617118885	
			YEL	617118883	BLA	617118886	
			BRN	617118887			
1712	Bottle Recycling Top for 1710	4	GRAY	617128881	BLUE	617128884	32
			RED	617128882	GRN	617128885	
			YEL	617128883	BLA	617128886	
			BRN	617128887			
1713	Paper/Bottle Recycling Top for 1710	4	GRAY	617138881	BLUE	617138884	32
			RED	617138882	GRN	617138885	
			YEL	617138883	BLA	617138886	
			BRN	617138887			
1714	Enclosed lid for 1710	4	GRAY	617148881	BLUE	617148884	32
			RED	617148882	GRN	617148885	
			YEL	617148883	BLA	617148886	
			BRN	617148887			
1720	Top for 1271	4	LGRAY	617208881			35
1721	Paper Recycling Top for 1720	4	GRAY	617218881	BLUE	617218884	35
			RED	617218882	GRN	617218885	
			YEL	617218883	BLA	617218886	
			BRN	617218887			
1722	Bottle Recycling Top for 1720	4	GRAY	617228881	BLUE	617228884	35
			RED	617228882	GRN	617228885	
			YEL	617228883	BLA	617228886	
			BRN	617228887			
1723	Paper/Bottle Recycling Top for 1720	4	GRAY	617238881	BLUE	617238884	35
			RED	617238882	GRN	617238885	
			YEL	617238883	BLA	617238886	
			BRN	617238887			
1724	Large Waste Recycling Top for 1720	4	GRAY	617248881	BLUE	617248884	35
			RED	617248882	GRN	617248885	
			YEL	617248883	BLA	617248886	
			BRN	617248887			
1725	Enclosed Lid for 1720	4	GRAY	617258881	BLUE	617258884	35
			RED	617258882	GRN	617258885	
			YEL	617258883	BLA	617258886	
			BRN	617258887			
1730	Top for 1215	4	LGRAY	617308881			33
1731	Paper Recycling Top for 1730	4	GRAY	617318881	BLUE	617318884	33
			RED	617318882	GRN	617318885	
			YEL	617318883	BLA	617318886	
			BRN	617318887			
1732	Bottle Recycling Top for 1730	4	GRAY	617328881	BLUE	617328884	33
			RED	617328882	GRN	617328885	
			YEL	617328883	BLA	617328886	
			BRN	617328887			

# PRODUCT INDEX

No.	Product Name	Pack	Color	Order Code	Color	Order Code	Page
1733	Paper/Bottle Recycling Top for 1730	4	GRAY	617338881	BLUE	617338884	33
			RED	617338882	GRN	617338885	
			YEL	617338883	BLA	617338886	
			BRN	617338887			
1734	Enclosed Lid for 1730	4	GRAY	617348881	BLUE	617348884	33
			RED	617348882	GRN	617348885	
			YEL	617348883	BLA	617348886	
			BRN	617348887			
1740	Top for 1215	4	LGRAY	617408881			34
1741	Paper Recycling Top for 1740	4	GRAY	617418881	BLUE	617418884	34
			RED	617418882	GRN	617418885	
			YEL	617418883	BLA	617418886	
			BRN	617418887			
1742	Bottle Recycling Top for 1740	4	GRAY	617428881	BLUE	617428884	34
			RED	617428882	GRN	617428885	
			YEL	617428883	BLA	617428886	
			BRN	617428887			
1743	Paper/Bottle Recycling Top for 1740	4	GRAY	617438881	BLUE	617438884	34
			RED	617438882	GRN	617438885	
			YEL	617438883	BLA	617438886	
			BRN	617438887			
1744	Enclosed Lid for 1740	4	GRAY	617448881	BLUE	617448884	34
			RED	617448882	GRN	617448885	
			YEL	617448883	BLA	617448886	
			BRN	617448887			
1750	Round Bins Lid for 1013	6	LGRAY	617508881			36
1751	Paper Recycling Top for 1750	6	GRAY	617518881	BLUE	617518884	36
			RED	617518882	GRN	617518885	
			YEL	617518883	BLA	617518886	
			BRN	617518887			
1752	Bottle and Can Recycling Top for 1750	6	GRAY	617528881	BLUE	617528884	36
			RED	617528882	GRN	617528885	
			YEL	617528883	BLA	617528886	
			BRN	617528887			
1753	Paper/Bottle Recycling Top for 1750	6	GRAY	617538881	BLUE	617538884	36
			RED	617538882	GRN	617538885	
			YEL	617538883	BLA	617538886	
			BRN	617538887			
1754	Large Waste Recycling Top for 1750	6	GRAY	617548881	BLUE	617548884	36
			RED	617548882	GRN	617548885	
			YEL	617548883	BLA	617548886	
			BRN	617548887			
1755	Enclosed Lid for 1750	6	GRAY	617558881	BLUE	617558884	36
			RED	617558882	GRN	617558885	
			YEL	617558883	BLA	617558886	
			BRN	617558887			
1811	Thor® Dolly for 1010/1012/1013/1014/1015	2	BLA	618118881			11, 29, 60, 61, 79
1812	Thor® Square Dolly for 1231/1233	2	BLA	618128881			29, 61, 187, 267
1813	Thor® Quiet Dolly for 1010/1012/1013/1014/1015	2	BLA	618138881			11, 29, 61
1814	Svelte® Rectangular Dolly, for 1211/1212/1213/1214/1220/1221	2	BLA	618148881			20, 62, 63, 78
1815	Svelte® Double-compartment Rectangular Dolly, for 1211/1212/1213/1214/1220/1221	1	BLA	618158881			20, 63
1816	Svelte® Tri-compartment Rectangular Dolly, for 1211/1212/1213/1214/1220/1221	1	BLA	618168881			20, 63
1817	Svelte® Four-compartment Rectangular Dolly, for 1211/1212/1213/1214/1220/1221	1	BLA	618178881			20, 63
1818	Thor® Drum Dolly for 1010/1012/1013/1014/1015/1231/1233	1	BLA	618188881			11, 29, 61
1819	Thor® Universal Drum Dolly	2	BLA	618198881			11
1821	Thor® Rim Caddy for 1014	1	YEL	618218881			60, 79
1822	Signboard Hook	6	BLA	618228881			61, 80
1823	Carry Caddy	4	BLA	618238881			61, 80
1824	Svelte® Rim Caddy for 1211/1213/1220	1	YEL	618248881	BLA	618248882	62, 78

No.	Product Name	Pack	Color	Order Code	Color	Order Code	Page
1825	Svelte® Dolly for 1211/1213/1220	2	BLA	618258881			62, 78
1826	Svelte® Connector for 1825	1	BLA	618268881			62, 78
1827	Svelte® Hook for 1824	4	YEL	618278881	BLA	618278882	62, 79
1828	Svelte® Caddy Bag for 1213	2	YEL	618288881	BLA	618288882	62, 79
1831	Thor® Caddy Bag for 1013/1014	6	YEL	618318881			60, 79
1839	Label Kit for 1750	1		618398881			36
1842	Label Kit for 1700	1		618428881			31
1843	Label Kit for 1211/1213	1		618438881			31, 33, 35, 36
1844	Label Kit for 1710	1		618448881			32
1845	Label Kit for 1211/1213	1		618458881			32
1846	Label Kit for 1720	1		618468881			35
1847	Label Kit for 1730	1		618478881			33
1848	Label Kit for 1740	1		618488881			34
1849	Label Kit for 1215	1		618498881			34
1851	Label Kit for 1241	1		618518881			38
1940	“Recyclable Waste” Label	10		619408881			20, 63
1941	“Soil” Label	10		619418881			20, 63
1942	“Building Materials” Label	10		619428881			20, 63
1943	“Garden Waste” Label	10		619438881			20, 63
1944	“Food Waste” Label	10		619448881			20, 63
1945	“Paint” Label	10		619458881			20, 63
1946	“Household and Garden Chemicals” Label	10		619468881			20, 63
1947	“Mixed paper and card” Label	10		619478881			20, 63
1948	“Plastics” Label	10		619488881			20, 63
1949	“Mixed Textiles and Clothes” Label	10		619498881			20, 63
1950	“Mixed Glass” Label	10		619508881			20, 63
1951	“Metal” Label	10		619518881			20, 63
1952	“Batteries” Label	10		619528881			20, 63
2011	Rockface® Container with an Ashtray Top, and 1281 Liner	1	BRN	620118881	LBRN	620118882	43
2012	Rockface® Container with a Funnel-top, and 1281 Liner	1	BRN	620128881	LBRN	620128882	43
2021	Rockface® Container with an Ashtray top, and 1282 Liner	1	BRN	620218881	BLA	620218883	43
			LBRN	620218882			
2022	Rockface® Container with a Funnel-top, and 1282 Liner	1	BRN	620228881	BLA	620228883	43
			LBRN	620228882			
2023	Rockface® Container with a Drum-type Top, and 1282 Liner	1	BRN	620238881	BLA	620238883	43
			LBRN	620238882			
2024	Rockface® Container with a Drum-type Ashtray Top, and 1282 Liner	1	BRN	620248881	BLA	620248883	43
			LBRN	620248882			
2031	Rockface® Container with a Drum-type Top, and 1283 Liner	1	BRN	620318881	BLA	620318883	43
			LBRN	620318882			
2032	Rockface® Container with a Drum-type Ashtray Top, and 1283 Liner	1	BRN	620328881	BLA	620328883	43
			LBRN	620328882			
2041	Rockface® Concrete Faceplate, for 2011/2012	4	CORL	620418881	ROCK	620418882	43
2042	Rockface® Concrete Faceplate, for 2021/2022/2023/2024	4	CORL	620428881	BSTONE	620428883	43
			ROCK	620428882			
2043	Rockface® Concrete Faceplate, for 2031/2032	4	CORL	620438881	BSTONE	620438883	43
			ROCK	620438882			
2044	Rockface® Ad Backing Faceplate, for 2031/2032	4	CLR	620448881			43
2051	Rockface® Container with a Drum-type Ashtray Top	1	BRN	620518881	EGRN	620518883	44
			GRAY	620518882			
2052	Rockface® Container with a Drum-type Top	1	BRN	620528881	EGRN	620528883	44
			GRAY	620528882			
2061	Rockface® Container with a Drum-type Ashtray Top	1	BRN	620618881	EGRN	620618883	44
			GRAY	620618882			
2062	Rockface® Container with a Drum-type Top	1	BRN	620628881	EGRN	620628883	44
			GRAY	620628882			
2071	Rockface® Container with a Drum-type Ashtray Top, Rod Openings	1	BRN	620718881	EGRN	620718883	44
			GRAY	620718882			
2072	Rockface® Container with a Drum-type Top, Rod Openings	1	BRN	620728881	EGRN	620728883	44
			GRAY	620728882			

# PRODUCT INDEX

No.	Product Name	Pack	Color	Order Code	Color	Order Code	Page
2081	Rockface® Container with a Drum-type Ashtray Top	1	BRN	620818881	EGRN	620818883	44
			GRAY	620818882			
2082	Rockface® Container with a Drum-type Top	1	BRN	620828881	EGRN	620828883	44
			GRAY	620828882			
2083	Rockface® Container with a Flat-type Top	1	BRN	620838881	EGRN	620838883	44
			GRAY	620838882			
2091	Rockface® Container with a Drum-type Top	1	BRN	620918881	EGRN	620918883	44
			GRAY	620918882			
2092	Rockface® Container with a Drum-type Top with Side Door	1	BRN	620928881	EGRN	620928883	44
			GRAY	620928882			
2093	Rockface® Container with a Flat-type Top	1	BRN	620938881	EGRN	620938883	44
			GRAY	620938882			
2101	Riston® Decorative Container	1	BLA	621018881	GRN	621018883	52
			BEIG	621018882			
2102	Riston® Decorative Container with Ashtray Top	1	BLA	621028881	GRN	621028883	52
			BEIG	621028882			
2103	Riston® Decorative Container with Tray Top	1	BLA	621038881	BEIG	621038882	52
2104	Riston® Paper Recycling Container	1	BLUE	621048881	GRN	621048882	38
2105	Riston® Bottle Recycling Container	1	BLUE	621058881	GRN	621058882	38
2106	Riston® Decorative Container	1	BLA	621068881	GRN	621068883	52
			BEIG	621068882			
2107	Riston® Decorative Container with Ashtray Top	1	BLA	621078881	GRN	621078883	52
			BEIG	621078882			
2111	Beaucan® Outdoor Decorative Trash Can, Two Sides of Movable Doors	1	BLA	621118881	BEIG	621118882	52
2112	Beaucan® Outdoor Decorative Trash Can, Four-sided Openings	1	BLA	621128881	BEIG	621128882	52
2113	Beaucan® Outdoor Decorative Trash Can, Two Sides of Movable Doors	1	BLA	621138881	BEIG	621138882	52
			BRN	621138883			
2200	Neatace® Trash Can, Dome Cover	1	BLA	622008881	BEIG	622008882	51
2201	Neatace® Trash Can, Ashtray Top Cover with Valves	1	BLA	622018881	BEIG	622018882	51
2202	Neatace® Trash Can, Ashtray Top Cover without Valves	1	BLA	622028881	BEIG	622028882	51
2203	Neatace® Trash Can, Open Top Cover	1	BLA	622038881	BEIG	622038882	51
2204	Neatace® Trash Can, Spherical Top Cover	1	BLA	622048881	BEIG	622048882	51
2205	Neatace® Trash Can, Spherical Top Cover, Top Open	1	BLA	622058881	BEIG	622058882	51
2206	Neatace® Trash Can, Dome Cover	1	BLA	622068881	BEIG	622068882	51
2207	Neatace® Trash Can, Ashtray Top Cover with Valves	1	BLA	622078881	BEIG	622078882	51
2208	Neatace® Trash Can, Ashtray Top Cover without Valves	1	BLA	622088881	BEIG	622088882	51
2209	Neatace® Trash Can, Open Top Cover	1	BLA	622098881	BEIG	622098882	51
2210	Neatace® Trash Can, Spherical Top Cover	1	BLA	622108881	BEIG	622108882	51
2211	Wall-mounted Cigarette Butts Bucket	1	MSILV	622118881			55
2212	Wall-mounted Cigarette Butts Bucket	1	TITA	622128881			56
2213	Neatace® Trash Can, Spherical Top Cover, Top Open	1	BLA	622138881	BEIG	622138882	51
2221	Wall-mounted Cigarette Butts Bucket	1	MSILV	622218881			55
2231	Floor-standing Cigarette Butts Bucket	1	MSILV	622318881			56
2241	Floor-standing Cigarette Butts Bucket	1	MSILV	622418881			56
2242	Wall-mounted Cigarette Butts Bucket	1	TITA	622428881			56
2251	Large-capacity Cigarette Butts Bucket	1	MSILV	622518881			57
2261	Floor-standing Cigarette Butt Bucket	1	MSILV	622618881			55
2262	Floor-standing Cigarette Butt Bucket	1	MSILV	622628881			57
2271	Floor-standing Cigarette Butt Bucket	1	MSILV	622718881			55
2281	Floor-standing Cigarette Butt Bucket	1	MSILV	622818881			55
2291	Floor-standing Cigarette Butt Bucket	1	MSILV	622918881			55
2300	Cigarette Barrel, Mirror Chrome	1	SS	623008881			58
2301	Cigarette Barrel, Satin Stainless Steel	1	SSS	623018881			58
2302	Cigarette Barrel, Titanium Surface	1	TITA	623028881			58
2303	Cigarette Barrel, Spray Surface	1	BLUE	623038881	GRAY	623038883	58
			GRN	623038882	RED	623038884	
2304	Cigarette Barrel, Mirror Foot Circle	1	GRAY	623048881	BLA	623048882	58
2305	Cigarette Barrel, Titanium Foot Circle	1	CR	623058881	EGRN	623058882	58
2310	Ashtray/Trash, Mirror Chrome	1	SS	623108881			45, 58
2311	Ashtray/Trash, Satin Stainless Steel	1	SSS	623118881			45, 58
2312	Ashtray/Trash, Titanium Surface	1	TITA	623128881			45, 58
2313	Ashtray/Trash, Spray Surface	1	BLUE	623138881	GRAY	623138883	47, 58
			GRN	623138882	RED	623138884	

No.	Product Name	Pack	Color	Order Code	Color	Order Code	Page
2314	Ashtray/Trash, Mirror Foot Circle	1	GRAY	623148881	BLA	623148882	46, 58
2315	Ashtray/Trash, Titanium Foot Circle	1	CR	623158881	EGRN	623158882	46, 58
2320	Container Open-top, Mirror Chrome	1	SS	623208881			45
2321	Container Open-top, Satin Stainless Steel	1	SSS	623218881			45
2322	Container Open-top, Titanium Surface	1	TITA	623228881			45
2323	Container Open-top, Spray Surface	1	BLUE	623238881	GRAY	623238883	47
			GRN	623238882	RED	623238884	
2324	Container Open-top, Mirror Foot Circle	1	GRAY	623248881	BLA	623248882	46
2325	Container Open-top, Titanium Foot Circle	1	CR	623258881	EGRN	623258882	46
2330	Ashtray/Trash, Mirror Chrome	1	SS	623308881			45, 58
2331	Ashtray/Trash, Satin Stainless Steel	1	SSS	623318881			45, 58
2332	Ashtray/Trash, Titanium Surface	1	TITA	623328881			45, 58
2333	Ashtray/Trash, Spray Surface	1	BLUE	623338881	GRAY	623338883	47, 58
			GRN	623338882	RED	623338884	
2334	Ashtray/Trash, Mirror Foot Circle	1	GRAY	623348881	BLA	623348882	46, 58
2335	Ashtray/Trash, Titanium Foot Circle	1	CR	623358881	EGRN	623358882	46, 58
2340	Container Flat-top, Mirror Chrome	1	SS	623408881			45
2341	Container Flat-top, Satin Stainless Steel	1	SSS	623418881			45
2342	Container Flat-top, Titanium Surface	1	TITA	623428881			45
2343	Container Flat-top, Spray Surface	1	BLUE	623438881	GRAY	623438883	47
			GRN	623438882	RED	623438884	
2344	Container Flat-top, Mirror Foot Circle	1	GRAY	623448881	BLA	623448882	46
2345	Container Flat-top, Titanium Foot Circle	1	CR	623458881	EGRN	623458882	46
2350	Container Round-top, Mirror Chrome	1	SS	623508881			45
2351	Container Round-top, Satin Stainless Steel	1	SSS	623518881			45
2352	Container Round-top, Titanium Surface	1	TITA	623528881			45
2353	Container Round-top, Spray Surface	1	BLUE	623538881	GRAY	623538883	47
			GRN	623538882	RED	623538884	
2354	Container Round-top, Mirror Foot Circle	1	GRAY	623548881	BLA	623548882	46
2355	Container Round-top, Titanium Foot Circle	1	CR	623558881	EGRN	623558882	46
2360	Container Round-top, Mirror Chrome	1	SS	623608881			45
2361	Container Round-top, Satin Stainless Steel	1	SSS	623618881			45
2362	Container Round-top, Titanium Surface	1	TITA	623628881			45
2363	Container Round-top, Spray Surface	1	BLUE	623638881	GRAY	623638883	47
			GRN	623638882	RED	623638884	
2364	Container Round-top, Mirror Foot Circle	1	GRAY	623648881	BLA	623648882	46
2365	Container Round-top, Titanium Foot Circle	1	CR	623658881	EGRN	623658882	46
2370	Container Open-top, Mirror Chrome	1	SS	623708881			45
2371	Steeledge Container Open-top, Satin Stainless Steel	1	SSS	623718881			45
2372	Steeledge Container Open-top, Titanium Surface	1	TITA	623728881			45
2373	Steeledge Container Open-top, Spray Surface	1	BLUE	623738881	GRAY	623738883	47
			GRN	623738882	RED	623738884	
2374	Steeledge Container Open-top, Mirror Foot Circle	1	GRAY	623748881	BLA	623748882	46
2375	Steeledge Container Open-top, Titanium Foot Circle	1	CR	623758881	EGRN	623758882	46
2391	Aluminum Trash Can	1	MSILV	623918881			47
2392	Aluminum Trash Can	1	MSILV	623928881			47
2393	Aluminum Trash Can	1	MSILV	623938881			47
2401	Stainless Trash Can	1	MSILV	624018881			27
2402	Stainless Trash Can	1	MSILV	624028881			27
2403	Stainless Trash Can	1	MSILV	624038881			27
25113	Hedgehog® Cleaning Tool Rack Base, 300mm	12	BLUE	572608881	RED	572608883	132, 265
			VGRN	572608882	GLD	572608885	
25114	Hedgehog® Cleaning Tool Rack Base, 500mm	12	BLUE	572618881	RED	572618883	132, 265
			VGRN	572618882	GLD	572618885	
25115	Hedgehog® Cleaning Tool Rack Base, 900mm	12	BLUE	572628881	RED	572628883	132, 265
			VGRN	572628882	GLD	572628885	
25116	Hedgehog® Small Stuck Clip	12	BLUE	572638881	RED	572638883	132, 265
			VGRN	572638882	GLD	572638885	
25117	Hedgehog® Large Stuck Clip	12	BLUE	572648881	RED	572648883	132, 265
			VGRN	572648882	GLD	572648885	
25118	Hedgehog® Hook	12	BLUE	572658881	RED	572658883	132, 265
			VGRN	572658882	GLD	572658885	
25119	Hedgehog® Signboard	12	BLUE	572668881	RED	572668883	132, 265
			VGRN	572668882	GLD	572668885	

# PRODUCT INDEX

No.	Product Name	Pack	Color	Order Code	Color	Order Code	Page
3011	Food Storage Box with Lid	6	GRAY	630118881	BLUE	630118885	171, 186
			WHT	630118882	GRN	630118886	
			RED	630118883	CLR	630118887	
			YEL	630118884			
3012	Food Storage Box with Lid	6	GRAY	630128881	BLUE	630128885	171, 186
			WHT	630128882	GRN	630128886	
			RED	630128883	CLR	630128887	
			YEL	630128884			
3013	Medical Waste Recycle Case	6	YEL	630138882	RED	630138883	41
3014	Medical Waste Recycle Case	6	YEL	630148882	RED	630148883	41
3021	Stackable Tote Bin	6	GRAY	630218881	YEL	630218884	172, 186
			WHT	630218882	BLUE	630218885	
			RED	630218883	GRN	630218886	
			YEL	630218884			
3022	Stackable Tote Bin	6	GRAY	630228881	YEL	630228884	172, 186
			WHT	630228882	BLUE	630228885	
			RED	630228883	GRN	630228886	
			YEL	630228884			
3023	Lid for 3021/3022	6	GRAY	630238881	YEL	630238884	172, 186
			WHT	630238882	BLUE	630238885	
			RED	630238883	GRN	630238886	
			YEL	630238884			
3511	Bitbar® Tool Box	1	BLA	635118881			171
3512	Bitbar® Tool Box With Cushion	1	BLA	635128881			171
3513	Castor Kit	1		635138881			171
3514	Multi-purpose Tool Box	1	BLA	635148881			171
3711	Shelving, 4-shelf Unit	1	BLA	637118881			170
3712	Shelving, 5-shelf Unit	1	BLA	637128881			170
3713	Shelving, 4-shelf Unit	1	BLA	637138881			170
3714	Shelving, 5-shelf Unit	1	BLA	637148881			170
3715	Shelving, 6-shelf Unit	1	BLA	637158881			170
3716	Mobile Shelf Truck, 5-shelf Unit	1	BLA	637168881			170
3717	Mobile Shelf Truck, 4-shelf Unit	1	BLA	637178881			170
3718	Lockable Doors for 3711/3712/3715/3716	1	BLA	637188881			170
3719	Enclosed Panels for 3711/3712/3715/3716	1	BLA	637198881			170
4010	Hi5® Utility Cart, 2-shelf Unit	1	BLA	640108881	OWHT	640108883	164, 232
			PLAT	640108882	GRAY	640108884	
4011	Hi5® Utility Cart, Open Sided	1	BLA	640118881	OWHT	640118883	164, 232
			PLAT	640118882	GRAY	640118884	
4012	Hi5® Utility Cart with Enclosed End Panels on 2 Sides	1	BLA	640128881	PLAT	640128882	164
4013	Hi5® Utility Cart with Lockable Doors, Sliding Drawer	1	BLA	640138881			164
4020	Hi5® Utility Cart, 2-shelf Unit	1	BLA	640208881			165
4021	Hi5® Utility Cart, Open Sided	1	OWHT	640218881	GRAY	640218883	165, 232
			BLA	640218882			
4022	Hi5® Utility Cart with Enclosed End Panels on 2 Sides	1	OWHT	640228881	BLA	640228882	165
4023	Hi5® Utility Cart with Enclosed End Panels on 3 Sides	1	OWHT	640238881	BLA	640238882	165, 232
4024	Hi5® Utility Cart with Lockable Doors, Sliding Drawer	1	GRAY	640248881			165
4025	Hi5® Equipment Cart	1	BLA	640258881			165
4026	Hi5® 4 Shelf Cart	1	BLA	640268881			165
4027	Hi5® Utility Cart with two sets of Lockable Doors	1	BLA	640278881			165
4031	Bitbar® Mobile Work Center with 4-drawer and Cabinet	1	BLA	640318881			146
4032	Bitbar® Mobile Work Center with 2-door Cabinet	1	BLA	640328881			146
4033	Bitbar® Mobile Work Center with 8-drawer	1	BLA	640338881			146
4041	Bitbar® 2-shelf Utility Cart	1	BLA	640418881	BEIG	640418882	147, 236
4042	Bitbar® Utility Cart with Drawer	1	BLA	640428881	BEIG	640428882	147
4043	Bitbar® 3-shelf Utility Cart	1	BLA	640438881	BEIG	640438882	147
4044	Bitbar® 2-shelf Utility Cart	1	BLA	640448881	BEIG	640448882	147, 236
4045	Bitbar® 2-shelf Utility Cart Flat Shelf	1	BLA	640458881	BEIG	640458882	147, 236
4046	Bitbar® 3-shelf Utility Cart	1	BLA	640468881	BEIG	640468882	147
4047	Bitbar® 3-shelf Utility Cart Flat Shelf	1	BLA	640478881	BEIG	640478882	147
4051	Ladder Cart	1	BLA	640518881			148
4061	Material Supply Cart	1	BLA	640618881			149
4062	Material Supply Cart	1	BLA	640628881			149
4063	Shelf for 4061	1	BLA	640638881			149
4064	Shelf for 4062	1	BLA	640648881			149
4065	Carton Recovery System	1	YEL	640658881			149

No.	Product Name	Pack	Color	Order Code	Color	Order Code	Page
4071	Hi5® Foldable Service Cart	1	BLA GRAY	640718881 640718882	BRN	640718883	166, 233
4072	Hi5® Foldable Service Cart	1	BLA GRAY	640728881 640728882	BRN	640728883	166, 233
4081	Hi5® Utility Cart	1	BLA	640818881			167, 234
4082	Hi5® Utility Cart with Enclosed End Panels on 3 Sides	1	BLA	640828881			167, 234
4083	Hi5® Utility Cart with Lockable Doors, Sliding Drawer	1	BLA	640838881			167, 234
4084	Hi5® Utility Cart with Lockable Doors, Enclosed Panels	1	BLA	640848881			167, 234
4085	Enclosed Panels	1	BLA	640858881			167, 235
4086	Lockable Doors	1	BLA	640868881			167, 235
4087	Trim Panel	1	BLA	640878881			167, 235
4411	Oeasy® Platform Truck	1	BLA	644118881			152, 232
4412	Oeasy® Platform Truck	1	BLA	644128881			152
4413	Oeasy® Platform Truck	1	BLA	644138881			152, 232
4414	Oeasy® Platform Truck	1	BLA	644148881			152
4415	Oeasy® Platform Truck	1	BLA	644158881			152
4416	Oeasy® Platform Truck	1	BLA	644168881			152
4417	Oeasy® Platform Truck	1	BLA	644178881			152
4418	Oeasy® Platform Truck	1	BLA	644188881			152
4421	Oeasy® Plate Truck	1	BLA	644218881			153
4422	Oeasy® Plate Truck	1	BLA	644228881			153
4423	Oeasy® Plate Truck	1	BLA	644238881			153
4431	Oeasy® Plate Truck	1	BLA	644318881			153
4432	Oeasy® Plate Truck	1	BLA	644328881			153
4433	Oeasy® Plate Truck	1	BLA	644338881			153
4441	Oeasy® Mobile Work Station	1	BLA	644418881			154
4442	Oeasy® Mobile Work Station	1	BLA	644428881			154
4443	Oeasy® Mobile Work Station	1	BLA	644438881			154
4451	Oeasy® Pipe Truck	1	BLA	644518881			155
4452	Oeasy® Pipe Truck	1	BLA	644528881			155
4453	Oeasy® Pipe Truck	1	BLA	644538881			155
4461	Oeasy® Platform Cart with Fence	1	BLA	644618881			156
4462	Oeasy® Platform Cart with Fence	1	BLA	644628881			156
4463	Oeasy® Platform Cart with Fence	1	BLA	644638881			156
4464	Oeasy® Platform Cart with Fence	1	BLA	644648881			156
4465	Oeasy® Platform Cart with Fence	1	BLA	644658881			156
4471	Oeasy® Semi-movable Traction Platform Truck	1	BLA	644718881			155
4472	Oeasy® Semi-movable Traction Platform Truck	1	BLA	644728881			155
4473	Oeasy® Semi-movable Traction Platform Truck	1	BLA	644738881			155
4474	Oeasy® Semi-movable Traction Jack Handle	1	BLA	644748881			155
4481	Utility Trolley, Utility Duty with 7.5cm Castors	1	BLA	644818881			156, 238
4482	Utility Trolley, Standard Duty with 12.5cm Castors	1	BLA	644828881			156, 238
4483	Trolley	1	BLA	644838881			157, 171, 186
4484	Cup Rack's Cart	1	PLAT	644848881	GRAY	644848882	238, 251
4485	Cup Rack's Cart with Handle	1	PLAT	644858881	GRAY	644858882	238, 251
4491	Goods Shelves	1	BLA	644918881			175, 185
4492	Goods Shelves	1	BLA	644928881			175, 185
4493	Goods Shelves	1	BLA	644938881			175, 185
4501	Storage Pallet, for 2 Drums	1	BLA	645018881			175
4502	Storage Pallet, for 4 Drums	1	BLA	645028881			175
4503	Slope, Used With 4501/4502	2	BLA	645038881			175
4512	Tilt Truck	1	BLA	645128881			160
4513	Cover for 4512/4522/4532/4542	1	BLA	645138881			162
4522	Tilt Truck, Utility Duty	1	BLA	645228881			160
4523	Tilt Truck, Standard Duty	1	BLUE	645238881			37
4532	Heavy-Duty Towable Tilt Truck	1	BLA	645328881			160
4542	Heavy-Duty Forkliftable Tilt Truck	1	BLA	645428881			161
4611	Tilt Truck, Utility Duty	1	BLA	646118881			161
4612	Tilt Truck, Standard Duty	1	BLA	646128881			161
4613	Tilt Truck, Utility Duty	1	BLA	646138881			161
4614	Tilt Truck, Standard Duty	1	BLA	646148881			161
4615	Cover for 4611/4612	1	BLA	646158881			162
4616	Cover for 4613/4614	1	BLA	646168881			162
4710	0.2m³ Cube Truck	2	BLA	647108881	WHT	647108882	158, 187

# PRODUCT INDEX

No.	Product Name	Pack	Color	Order Code	Color	Order Code	Page
4711	0.3m <sup>3</sup> Cube Truck	2	BLA	647118881	YEL	647118884	158, 187
			WHT	647118882	RED	647118885	
			GRN	647118883			
4712	Heavy-Duty Utility Truck	2	BLA	647128881			158
4713	Lid for 4711/4712	1	BLA	647138881			158
4714	0.4m <sup>3</sup> Cube Truck	2	BLA	647148881	WHT	647148882	158, 187
4715	0.5m <sup>3</sup> Cube Truck	2	BLA	647158881	WHT	647158882	158, 187
4724	0.4m <sup>3</sup> Cube Truck	2	BLUE	647248881			37
4725	0.5m <sup>3</sup> Cube Truck	2	BLUE	647258881			37
4811	15 L Utility Bin	2	BLA	648118881			167, 168, 235
4821	30 L Utility Bin	2	BLA	648218881			167, 168, 235
4830	Hook Kit (Set of 4)	1	BLA	648308881			168
4831	20cm Pneumatic Castor Kit	1		648318881			168
4832	Ultra Silent Castor Kit (Set of 4)	1	GRAY	648328881			168
4841	Single Full Extension Drawer	1	RED	648418881			168
4850	Utility Sliding Drawer	1	BLA	648508881			168
4851	Utility Sliding Drawer	1	BLA	648518881	BRN	648518882	69, 73, 167, 168, 235
5010	Clip for Handle	6	BLA	650108881	PLAT	650108882	77
5011	Grandmaid® Cleaning Cart	1	BLA	650118881	PLAT	650118882	76
5012	Trash Bags Cover, for 5011	2	BLA	650128881	PLAT	650128882	77
5013	Spray bottle stack	2	BLA	650138881			77
5014	Storage Cabinet	1	BLA	650148881	PLAT	650148882	77
5015	Lockable Top Cover, for 5011	1	BLA	650158881	PLAT	650158882	77
5016	Garbage Classification Fixed Frame	1	BLA	650168881			77
5017	Cleaning Tool Bracket	6	BLA	650178881			77
5018	Small Garbage Bag	6	BLUE	650188881			77
5019	Locking Door Kit for 5011	1	YEL	650198881	BLA	650198882	77
5021	Grandmaid® Housekeeping Cart	1	BLA	650218881	PLAT	650218882	68
5022	Grandmaid® Housekeeping Cart with Doors	1	BLA	650228881			68
5023	Cart with Doors, Protective Security Hood	1	BLA	650238881			68
5024	Adjustable Shelf Kit for 5021/5022/5023/5031	1	BLA	650248881	PLAT	650248882	69
5025	Under Deck Shelf Kit for 5021/5022/5023/5031	1	BLA	650258881	PLAT	650258882	71
5026	Locking Door Kit for 5021/5022/5023	1	BLA	650268881	BRN	650268882	69
5027	Protective Security Hood for 5021/5022/5023/5031	1	BLA	650278881	PLAT	650278882	69
5028	Cover, Work in Couple with 6968/6974/6977	2	BLA	650288881	PLAT	650288882	69
5029	Amenity Organizer	6	BLA	650298881			69
5030	Amenity Organizer	6	BLA	650308881			69
5031	Grandmaid® Compact Housekeeping Cart	1	BLA	650318881	PLAT	650318882	70
5033	Storage Accessory for 5031	1	BLA	650338881	PLAT	650338882	71
5035	Locking Door Kit for 5031	1	BLA	650358881	BRN	650358882	71
5036	Cleaning Tool Stack for 5031	2	BLA	650368881			71, 73
5037	Hook Kit (Set of 4, RED, YEL, BLUE, GRN) for 5031/5051	1		650378881			71, 73
5038	Tops work with 1213	2	BLA	650388881	PLAT	650388881	71
5039	Protective Security Hood for 5021/5022/5023/5031	1	BLA	650398881			69
5041	X Type Linen Cart	1	GRAY	650418881			82
5042	X Type Linen Cart	1	GRAY	650428881			82
5043	Cloth/Straw Bag, for 5041	2	BRN	650438881			82
5044	Cloth/Straw Bag, for 5042	2	BRN	650448881			82
5045	Classification Linen Cart	1	GRAY	650458881			81
5046	Classification Linen Cart	1	GRAY	650468881			81
5047	Cloth/Straw Bag, for 5045	2	BLA	650478881			81
5048	Cloth/Straw Bag, for 5046	2	BLA	650488881			81
5051	Grandmaid® Cruise Housekeeping Cart	1	BLA	650518881	PLAT	650518882	70
5052	Locking Door Kit for 5051	1	BLA	650528881	BRN	650528882	71
5053	Under Deck Shelf Kit for 5051	1	BLA	650538881	PLAT	650538882	71
5054	Vinyl Bag for 5051	2	BRN	650548881			71
5055	Tops work with 1215	2	BLA	650558881			71
5056	Garbage Classification Fixed Frame (½ Separated), for 5021/5022/5023/5031	1	BLA	650568881			69
5057	Garbage Classification Fixed Frame (⅓ and ⅔ Separated), for 5021/5022/5023/5031	1	BLA	650578881			69
5061	Pinnacle® Intelligent Housekeeping Cart	1	BLA	650618881			72
5062	Pinnacle® Intelligent Housekeeping Cart	1	BLA	650628881			72
5063	Pinnacle® Intelligent Housekeeping Cart	1	BLA	650638881			72

No.	Product Name	Pack	Color	Order Code	Color	Order Code	Page
5064	Pinnacle® Intelligent Housekeeping Cart	1	BLA	650648881			72
5065	Adjustable Shelf Kit	1	BLA	650658881			73
5066	Locking Door Kit for 5061/5063/5071/5073	1	BLA	650668881			73
5067	Safety Shield	1	BLA	650678881	PLAT	650678882	69, 73
5068	Vinyl Bag for 5061/5063/5071/5073	6	BLA	650688881			73
5069	Vinyl Bag for 5062/5064/5072/5074	6	BLA	650698881			73
5070	Locking Door Kit for 5062/5064/5072/5074	1	BLA	650708881			73
5071	Pinnacle® Intelligent Housekeeping Cart with Built-In Divider	1	BLA	650718881			72
5072	Pinnacle® Intelligent Housekeeping Cart with Built-In Divider	1	BLA	650728881			72
5073	Pinnacle® Intelligent Housekeeping Cart with Built-In Divider	1	BLA	650738881			72
5074	Pinnacle® Intelligent Housekeeping Cart with Built-In Divider	1	BLA	650748881			72
5075	Battery Charger	1	BLA	650758881			73
5076	Battery Pack	1	BLA	650768881			73
5077	Safety Shield, No Flipped Door	1	BLA	650778881	PLAT	650778882	69
5081	Cleabox Room Service Cart	1	BRN	650818881			74
5082	Cleabox Room Service Cart	1	BRN	650828881			74
5083	Cleabox Room Service Cart	1	BRN	650838881			74
5084	Tool Basket	1	BRN	650848881			74
5085	Lined Bag for 5081	1	BLA	650858881			74
5086	Lined Bag for 5082	1	BLA	650868881			74
5087	Lined Bag for 5083	1	BLA	650878881			74
5088	Collapsible Linen Cart	1	GRAY	650888881			81, 162
5089	Collapsible Linen Cart	1	GRAY	650898881			81, 162
5090	Collapsible Linen Cart	1	GRAY	650908881			81, 162
5091	Cloth/Straw Bag, for 5088	2	BLA	650918881			81, 162
5092	Cloth/Straw Bag, for 5089	2	BLA	650928881			81, 162
5093	Cloth/Straw Bag, for 5090	2	BLA	650938881			81, 162
5094	Cover for 5088	2	BLA	650948881			81, 162
5095	Fabric Hanging Organizer for 5041	2	BRN	650958881			82
5096	Fabric Hanging Organizer for 5042	2	BRN	650968881			82
5097	Cover for 5045/5089	2	BLA	650978881			81, 162
5098	Cover for 5046/5090	2	BLA	650988881			81, 162
5210	Wringer for 5211	1	YEL	652108881	GRN	652108883	84
			BLUE	652108882	RED	652108884	
5211	All-in-one Bucket	1	YEL	652118881	GRN	652118883	84
			BLUE	652118882	RED	652118884	
5221	Grandmaid® Bucket with Kits	4	YEL	652218881	GRN	652218883	85, 87
			BLUE	652218882	RED	652218884	
			BRN	652218885			
5222	Grandmaid® Side Press Wringer for 5221	2	YEL	652228881	GRN	652228883	85, 87
			BLUE	652228882	RED	652228884	
			BRN	652228885			
5223	Grandmaid® Side Press Combo	1	YEL	652238881	BRN	652238882	85
5224	Grandmaid® Bucket with Kits	4	RED	652248881	GRN	652248884	85, 86, 87
			YEL	652248882	BRN	652248885	
			BLUE	652248883			
5225	Grandmaid® Side Press Wringer for 5224/5229	2	RED	652258881	GRN	652258884	85, 87
			YEL	652258882	BRN	652258885	
			BLUE	652258883			
5226	Grandmaid® Side Press Combo	1	YEL	652268881	BRN	652268882	85
			GRN	652268883	RED	652268884	
			BLUE	652268885			
5227	Grandmaid® Down Press Wringer for 5224/5229	2	RED	652278881	GRN	652278884	86, 87
			YEL	652278882	BRN	652278885	
			BLUE	652278883			
5228	Grandmaid® Down Press Combo	1	YEL	652288881	BRN	652288882	86
5229	Grandmaid® Bucket with Kits	4	YEL	652298881			85, 86, 87
5231	Pail and Mop Strainer Combination	6	GRAY	652318881			88
5241	Double Pails	6	GRAY	652418881			89
5242	Double Pails	6	GRAY	652428881			89

# PRODUCT INDEX

No.	Product Name	Pack	Color	Order Code	Color	Order Code	Page
5251	Bucket	12	GRAY	652518881	RED	652518882	90
			YEL	652518883	BLUE	652518884	
			GRN	652518885	WHT	652518886	
5252	Bucket	6	GRAY	652528881	RED	652528882	90
			YEL	652528883	BLUE	652528884	
			GRN	652528885	WHT	652528886	
5253	Bucket	12	GRAY	652538881	BLUE	652538884	90
			RED	652538882	GRN	652538885	
			YEL	652538883			
5254	Bucket	6	GRAY	652548881	BLUE	652548884	90
			RED	652548882	GRN	652548885	
			YEL	652548883			
5261	Dirty Water Bucket for 5221	2	YEL	652618881	RED	652618882	85, 87
5262	Bucket for 5211	2	YEL	652628881	GRN	652628883	84
			BLUE	652628882	RED	652628884	
5263	Dirty Water Bucket for 5224	2	YEL	652638881	RED	652638882	85, 86, 87
5264	Quadrate Bucket	6	YEL	652648881	GRN	652648884	77, 90
			RED	652648882	BLA	652648885	
			BLUE	652648883			
5265	Quadrate Bucket	6	YEL	652658881	BLUE	652658883	90
			RED	652658882	GRN	652658884	
5266	Drawer	2	YEL	652668881	BLA	652668882	77
5267	Cleaning Bucket (4 colors per set)	1	N/A	652678881			77
5268	Tool Box	1	YEL	652688881	GRAY	652688882	77
5271	Cotton Mop and Handle Combination	4	WHT	652718881			88
5272	Replacement Mop for 5271	12	WHT	652728881			88
5273	Steel Sponge Mop with Cellulose Head	6	BLUE	652738881			89
5274	Steel Cellulose Replacement Head	12	YEL	652748881			89
5275	PVA Sponge Mop	4	BLA	652758881			89
5276	PVA Sponge Mop Refill	12		652768881			89
5281	Roller Mop Bucket and Wringer	1	MSILV	652818881			88
5300	Grandmaid® Side Press Combo	1	YEL	653008881			85
5301	Grandmaid® Down Press Wringer for 5224	1	YEL	653018881			86
5310	Quiet Castor Dolly	1	BLA	653108881			87
5311	Grandmaid® Dual-water Side Press Comb	1	YEL	653118881			87
5312	Grandmaid® Dual-water Down Press Comb	1	YEL	653128881			87
5621	1cm Cleaning Brush for Pipeline	12	WHT	656218881			125
5633	1.3cm Cleaning Brush for Pipeline	12	WHT	656338881			125
5641	1.6cm Cleaning Brush for Pipeline	12	WHT	656418881			125
5652	1.9cm Cleaning Brush for Pipeline	12	WHT	656528881			125
5663	2.5cm Cleaning Brush for Pipeline	12	WHT	656638881			125
5672	3.8cm Cleaning Brush for Pipeline	12	WHT	656728881			125
5683	5.1cm Cleaning Brush for Pipeline	12	WHT	656838881			125
5691	Round Vegetable Cleaning Brush	12	WHT	656918881			258
5692	Oval Multipurpose Cleaning Brush	12	WHT	656928881			258
5701	Bottle Cleaning Brush	12	WHT	657018881			258
5702	Bottle Cleaning Brush	12	WHT	657028881			258
5711	Hook-shaped Brush for Pipeline	12	RED	657118881	GRN	657118884	125
			YEL	657118882	WHT	657118885	
			BLUE	657118883			
5712	Circular Brush for Pipeline	12	RED	657128881	GRN	657128884	125
			YEL	657128882	WHT	657128885	
			BLUE	657128883			
5721	0.63cm Pipe Opening Brush	12	WHT	657218881			263
5722	0.95cm Pipe Opening Brush	12	WHT	657228881			263
5723	1.9-3.8cm Pipe Opening Brush	12	WHT	657238881			263
5724	1.27-2.54cm Pipe Opening Brush	12	WHT	657248881			263
5731	3.5cm High-temperature Cleaning Brush	12	WHT	657318881			263
5732	2.2cm L-shaped High-temperature Cleaning Brush	12	WHT	657328881			263
5733	5cm L-shaped High-temperature Cleaning Brush	12	WHT	657338881			263
5734	5cm Ring-shaped High-temperature Cleaning Brush	6	WHT	657348881			263
5741	3.8cm Semicircular Coffee Machine Cleaning Brush	12	WHT	657418881			263
5742	1.6cm Coffee Machine Cleaning Brush	12	WHT	657428881			263

No.	Product Name	Pack	Color	Order Code	Color	Order Code	Page
6013	Blend Mop	6	WHT	660138881	GRN	660138883	94
			BLUE	660138882	RED	660138884	
6014	Blend Mop	6	WHT	660148881	GRN	660148883	94
			BLUE	660148882	RED	660148884	
6015	Blend Mop	6	WHT	660158881	GRN	660158883	94
			BLUE	660158882	RED	660158884	
6016	Blend Mop	6	WHT	660168881	GRN	660168883	94
			BLUE	660168882	RED	660168884	
6023	Cotton Mop	12	WHT	660238881			94
6024	Cotton Mop	12	WHT	660248881			94
6025	Cotton Mop	12	WHT	660258881			94
6026	Cotton Mop	12	WHT	660268881			94
6033	Medium Superfine Fiber Mop	12	WHT	660338881			94
6034	Large Superfine Fiber Mop	12	WHT	660348881			94
6035	Superfine Fiber Mop	12	WHT	660358881			94
6036	Superfine Fiber Mop	12	WHT	660368881			94
6043	Finish Mop	6	WHT/	660438882			95
			BLUE				
6044	Finish Mop	6	WHT/ BLUE	660448882			95
6053	Clean Room Mop, Medium	12	WHT	660538881			95
6054	Clean Room Mop, Large	12	WHT	660548881			95
6055	Clean Room Mop, Medium	12	WHT	660558881			95
6056	Clean Room Mop, Large	12	WHT	660568881			95
6062	Superfine Fiber Mop	12	WHT	660628881			96
6063	Superfine Fiber Mop	12	WHT	660638881			96
6064	Superfine Fiber Mop With Plastic Threaded Tip	12	WHT	660648881			96
6065	Super Fiber Mop	12	WHT	660658881			96
6066	Super Fiber Mop	12	WHT	660668881			96
6072	Quick Connect Mop	24	WHT	660728881	GRN	660728883	97
			BLUE	660728882	RED	660728884	
6073	Quick Connect Mop	24	WHT	660738881	GRN	660738883	97
			BLUE	660738882	RED	660738884	
6082	Microfiber Tube Mop	6	GRN	660828881			96
6083	Microfiber Tube Mop	6	GRN	660838881			96
6084	Microfiber Tube Mop	6	GRN	660848881			96
6085	Microfiber Tube Mop	6	GRN	660858881			96
6092	Microfiber String Mop	6	GRN	660928881			97
6093	Microfiber String Mop	6	GRN	660938881			97
6094	Microfiber String Mop	6	GRN	660948881			97
6095	Microfiber String Mop	6	GRN	660958881			97
6103	Antibiotic Blended Mop	6	GRN	661038881			98
6104	Antibiotic Blended Mop	6	GRN	661048881			98
6105	Antibiotic Blended Mop	6	GRN	661058881			98
6106	Antibiotic Blended Mop	6	GRN	661068881			98
6112	Economy Cotton Mop, Small	12	WHT	661128881			95
6113	Economy Cotton Mop, Small	12	WHT	661138881			95
6123	Antibiotic Microfiber Mop	6	GRN	661238881			98
6124	Antibiotic Microfiber Mop	6	GRN	661248881			98
6125	Antibiotic Microfiber Mop	6	GRN	661258881			98
6126	Antibiotic Microfiber Mop	6	GRN	661268881			98
6133	Medium Synthetic Fiber Mop	6	WHT	661338881	GRN	661338883	98
			BLUE	661338882	RED	661338884	
6134	Large Synthetic Fiber Mop	6	WHT	661348881	GRN	661348883	98
			BLUE	661348882	RED	661348884	
6135	Medium Synthetic Fiber Mop	6	WHT	661358881	GRN	661358883	98
			BLUE	661358882	RED	661358884	
6136	Large Synthetic Fiber Mop	6	WHT	661368881	GRN	661368883	98
			BLUE	661368882	RED	661368884	
6311	Side Gate Mop Handle	12	RED	663118881	GRN	663118883	100
			BLUE	663118882	GRAY	663118884	
			YEL	663118885			

# PRODUCT INDEX

No.	Product Name	Pack	Color	Order Code	Color	Order Code	Page
6312	Side Gate Mop Handle	12	RED	663128881	GRN	663128883	100
			BLUE	663128882	GRAY	663128884	
			YEL	663128885			
6313	Side Gate Mop Handle	12	LAC	663138881			100
6314	Side Gate Mop Handle	12	LAC	663148881			100
6315	Side Gate Mop Handle	12	MSILV	663158881			100
6316	Side Gate Mop Handle	12	MSILV	663168881			100
6321	Clamp Style Mop Handle	12	RED	663218881	GRN	663218883	100
			BLUE	663218882	GRAY	663218884	
			YEL	663218885			
6322	Clamp Style Mop Handle	12	RED	663228881	GRN	663228883	100
			BULE	663228882	GRAY	663228884	
			YEL	663228885			
6323	Clamp Style Mop Handle	12	RED	663238881	GRN	663238883	100
			BLUE	663238882	GRAY	663238884	
			YEL	663238885			
6324	Clamp Style Mop Handle	12	RED	663248881	GRN	663248883	100
			BLUE	663248882	GRAY	663248884	
			YEL	663248885			
6325	Clamp Style Mop Handle, Hardwood Handle	12	LAC	663258881			100
6326	Clamp Style Mop Handle, Hardwood Handle	12	LAC	663268881			100
6327	Clamp Style Mop Handle	12	MSILV	663278881			100
6328	Clamp Style Mop Handle	12	MSILV	663288881			100
6331	Hinged Side Gate Mop Handle	12	BLUE	663318881			101
6332	Hinged Side Gate Mop Handle	12	BLUE	663328881			101
6341	Steel Mop Handle, Hardwood Handle	12	LAC	663418881			101
6342	Steel Mop Handle, Hardwood Handle	12	LAC	663428881			101
6350	Steel Broom Handle, Threaded	12	BLA	663508881			121
6351	Steel Broom Handle, with Threaded Tips	12	BLUE	663518881	YEL	663518883	121
			RED	663518882	GRN	663518884	
6352	Wood Handle, Threaded	12	LAC	663528881			121
6353	Wood Handle, Threaded	12	LAC	663538881			121
6362	Wood Handle, Tapered	12	LAC	663628881			121
6363	Wood Handle, Tapered	12	LAC	663638881			121
6388	Wood Handle, Threaded Metal Tip	12	LAC	663888881			121
6389	Steel Broom Handle, with Metal Threaded Tips	12	BLA	663898881			121
6411	Naelc® 51.0-102.0cm Quick-connect Short Extension Handle	6	YEL	664118881			103
6412	Naelc® 122.0-183.0cm Quick-connect Straight Extension Handle	6	YEL	664128881			103
6413	Naelc® Quick Connect Handle	12	YEL	664138881	RED	664138882	101
			BLUE	664138883	GRN	664138884	
			GRAY	664138885			
6414	Naelc® Quick Connect Handle	12	YEL	664148881	BLUE	664148883	101
			RED	664148882	GRN	664148884	
6415	Naelc® Quick-connect Adapter	3	BLA	664158881			101, 103
6416	Naelc® Quick Connect Handle	6	YEL	664168881			103
6417	Naelc® Quick Connect Handle	6	YEL	664178881			103
6420	Naelc® 28cm Quick-connect Wall/Stair Frame	6	BLA	664208881			103
6421	Naelc® 46cm Quick-connect Frame	6	BLA	664218881			103
6422	Naelc® 61cm Quick-connect Frame	6	BLA	664228881			103
6423	Naelc® 91cm Quick-connect Frame	6	BLA	664238881			103
6424	Naelc® 122cm Quick-connect Frame	6	BLA	664248881			103
6425	Naelc® 152cm Quick-connect Frame	6	BLA	664258881			103
6431	U-Rag® Microfiber Bathroom Cloth	12	YEL	664318881			108
6432	U-Rag® Microfiber General Purpose Cloth	12	GRN	664328881	BLUE	664328883	108
			RED	664328882			
6433	U-Rag® Microfiber Glass/Mirror Cloth	12	BLUE	664338881			108
6434	U-Rag® Microfiber XL General Purpose Cloth	12	GRN	664348881			108
6435	U-Rag® Microfiber Bathroom Cloth	12	YEL	664358881			108
6436	U-Rag® Microfiber General Purpose Cloth	12	GRN	664368881	BLUE	664368883	108
			RED	664368882			
6437	U-Rag® Microfiber Glass/Mirror Cloth	12	BLUE	664378881			108
6441	U-Rag® Microfiber All Purpose Mitt with Thumb	12	GRN	664418881			109
6442	U-Rag® Microfiber Glass/Mirror Mitt with Thumb	12	BLUE	664428881			109

No.	Product Name	Pack	Color	Order Code	Color	Order Code	Page
6443	U-Rag® Microfiber Dusting Mitt with Thumb	6	GRN	664438881			109
6451	U-Rag® Quick-Connect Flexible Dusting Wand with Microfiber Sleeve	6	GRN	664518881			110
6452	U-Rag® Wand Duster Microfiber Replacement Sleeve	6	GRN	664528881			110
6453	U-Rag® Quick-Connect Flexible Dusting Wand with High Performance Sleeve	6	WHT	664538881			110
6454	U-Rag® Wand Duster High Performance Microfiber Replacement Sleeve	6	WHT	664548881			110
6461	Naelc® 46cm Microfiber Fringed Dust Mop	6	GRN	664618881			104
6462	Naelc® 61cm Microfiber Fringed Dust Mop	6	GRN	664628881			104
6463	Naelc® 91cm Microfiber Fringed Dust Mop	6	GRN	664638881			104
6464	Naelc® 122cm Microfiber Fringed Dust Mop	6	GRN	664648881			104
6465	Naelc® 152cm Microfiber Fringed Dust Mop	6	GRN	664658881			104
6471	Naelc® 46cm Microfiber Room Dust Mop	12	GRN	664718881	WHT	664718882	104
6472	Naelc® 61cm Microfiber Hall Dust Mop	12	GRN	664728881			104
6473	Naelc® 91cm Microfiber Hall Dust Mop	12	GRN	664738881			104
6474	Naelc® 122cm Microfiber Hall Dust Mop	12	GRN	664748881			104
6481	U-Rag® Superfine Fiber Cloth	144	RED	664818881			109, 265
6482	U-Rag® Superfine Fiber Cloth	144	YEL	664828881			109, 265
6483	U-Rag® Superfine Fiber Cloth	144	BLUE	664838881			109, 265
6484	U-Rag® Superfine Fiber Cloth	144	GRN	664848881			109, 265
6485	U-Rag® Light Microfiber Cloth	144	RED	664858881			108
6486	U-Rag® Light Microfiber Cloth	144	YEL	664868881			108
6487	U-Rag® Light Microfiber Cloth	144	BLUE	664878881			108
6488	U-Rag® Light Microfiber Cloth	144	GRN	664888881			108
6500	Naelc® 28cm Microfiber Damp Room Mop	6	BLUE	665008881			104
6501	Naelc® 46cm Microfiber Super Scrubber Mop	6	YEL	665018881			104
6502	Naelc® 46cm Microfiber Damp Room Mop	12	BLUE	665028881	RED	665028883	104
			GRN	665028882			
6503	Naelc® 61cm Microfiber Damp Room Mop	12	BLUE	665038881			104
6511	Naelc® Snap-on Wire Dust Mop Handle	12	LAC	665118881			105
6512	Wedge Mop Handle and Frame	12	LAC	665128881			105
6513	Naelc® Snap-on Wire Dust Mop Handle	12	MSILV	665138881			105
6520	Naelc® Dust Mop Frame	12	BLA	665208881			105
6521	Naelc® Dust Mop Frame	12	BLA	665218881			105
6522	Naelc® Dust Mop Frame	12	BLA	665228881			105
6523	Naelc® Dust Mop Frame	12	BLA	665238881			105
6524	Naelc® Dust Mop Frame	12	BLA	665248881			105
6530	Naelc® Dust Mop	12	WHT	665308881	BLUE	665308882	105
6531	Naelc® Dust Mop	12	WHT	665318881	BLUE	665318882	105
6532	Naelc® Dust Mop	12	WHT	665328881	BLUE	665328882	105
6533	Naelc® Dust Mop	12	WHT	665338881	BLUE	665338882	105
6534	Naelc® Dust Mop	12	WHT	665348881	BLUE	665348882	105
6561	Wedge Mop Dust Mop Head, Looped-end	12	YEL	665618881			105
6562	Wedge Mop Dust Mop Head, Cut-end	12	YEL	665628881			105
6571	U-Rag® Light Microfiber Cloth	144	RED	665718881			108
6572	U-Rag® Light Microfiber Cloth	144	YEL	665728881			108
6573	U-Rag® Light Microfiber Cloth	144	BLUE	665738881			108
6574	U-Rag® Light Microfiber Cloth	144	GRN	665748881			108
6601	Steel Scouring Pad Bracket	12	BLUE	666018881			123
6602	Light Scouring Pad	12	WHT	666028881			123
6603	Medium Scouring Pad	12	BLUE	666038881			123
6604	Medium Scouring Pad	12	BLA	666048881			123
6605	Light Scouring Pad Brush	12	WHT	666058881			123
6606	Medium Scouring Pad Brush	12	BLUE	666068881			123
6607	Heavy-duty Scouring Pad Brush	12	BLA	666078881			123
6611	Potato Cleaning Brush	12	WHT	666118881			262
6613	Angle Broom	12	YEL	666138882			114
6621	Angle Broom with Handle, PET Fill	6	YEL	666218883	BLA	666218884	114
6622	Angle Broom, PP Fill	12	YEL	666228881			114
6623	Angle Broom, PET Fill	12	RED	666238881	GRN	666238884	114, 262
			YEL	666238882	WHT	666238885	
			BLUE	666238883	BLA	666238886	
6624	Angle Broom with Handle, PET Fill	12	BLA	666248881			114
6632	Plastic Foam Block, Fine Floor Sweep, PET Fill	12	BLA	666328881	YEL	666328882	114

# PRODUCT INDEX

No.	Product Name	Pack	Color	Order Code	Color	Order Code	Page
6633	Plastic Foam Block, Fine Floor Sweep, PET Fill	12	BLA	666338881	YEL	666338882	114
6634	Handwood Foam Block, Fine Floor Sweep, PET Fill	2	LAC	666348881			114
6642	Plastic Foam Block, Fine Floor Sweep, Tampico Fill with Horsehair Border	12	BLA	666428881	YEL	666428882	114
6643	Plastic Foam Block, Fine Floor Sweep, Tampico Fill with Horsehair Border	12	BLA	666438881	YEL	666438882	114
6644	Hardwood Block, Fine Floor Sweep, Tampico Fill with Horsehair Border	2	LAC	666448881			114
6652	Plastic Foam Block, Medium Floor Sweep, PP Fill	12	BLA	666528881	YEL	666528882	115
6653	Plastic Foam Block, Medium Floor Sweep, PP Fill	12	BLA	666538881	YEL	666538882	115
6654	Hardwood Block, Medium Floor Sweep, PP Fill	2	LAC	666548881			115
6662	Plastic Foam Block, Medium Floor Sweep, Tampico Fill	12	BLA	666628881	YEL	666628882	115
6663	Plastic Foam Block, Medium Floor Sweep, Tampico Fill	12	BLA	666638881	YEL	666638882	115
6664	Hardwood Block, Medium Floor Sweep, Tampico Fill	2	LAC	666648881			115
6672	Plastic Foam Block, Medium Floor Sweep, PET and PP Fill	12	BLA	666728881	YEL	666728882	115
6673	Plastic Foam Block, Medium Floor Sweep, PET and PP Fill	12	BLA	666738881	YEL	666738882	115
6674	Hardwood Block, Medium Floor Sweep, PET and PP Fill	2	LAC	666748881			115
6682	Plastic Foam Block, Heavy-Duty Floor Sweep, PP Fill	12	BLA	666828881	YEL	666828882	115
6683	Plastic Foam Block, Heavy-Duty Floor Sweep, PP Fill	12	BLA	666838881	YEL	666838882	115
6684	Hardwood Block, Heavy-Duty Floor Sweep, PP Fill	2	LAC	666848881			115
6692	Plastic Foam Block, Heavy-Duty Floor Sweep, Palmyra Fill	12	BLA	666928881	YEL	666928882	115
6693	Plastic Foam Block, Heavy-Duty Floor Sweep, Palmyra Fill	12	BLA	666938881	YEL	666938882	115
6694	Hardwood Block, Heavy-Duty Floor Sweep, Palmyra Fill	2	LAC	666948881			115
6695	45cm Floor Sweep, PET Fill	12	RED	666958881	GRN	666958884	260
			YEL	666958882	WHT	666958885	
			BLUE	666958883			
6696	61cm Floor Sweep, PET Fill	12	RED	666968881	GRN	666968884	260
			YEL	666968882	WHT	666968885	
			BLUE	666968883			
6701	Counter Brush, PET Fill	6	BLA	667018881	YEL	667018882	119
6702	Counter Brush, PP Fill	6	BLA	667028881	YEL	667028882	119
6703	Counter Brush, Tampico Fill	6	BLA	667038881	YEL	667038882	119
6704	Counter Brush, PET Fill	6	BLA	667048881	YEL	667048882	119
6705	Counter Brush, PET Fill	12	RED	667058881	GRN	667058884	260
			YEL	667058882	WHT	667058885	
			BLUE	667058883			
6706	Counter Brush, PET Fill	12	RED	667068881	GRN	667068884	260
			YEL	667068882	WHT	667068885	
			BLUE	667068883			
6712	Short Plastic Handle Utility Brush, Palmyra Fill	6	BLA	667128881	YEL	667128882	119
6713	Long Plastic Handle Utility Brush, Palmyra Fill	6	BLA	667138881	YEL	667138882	119
6714	Short Handle Multi-purpose Cleaning Brush, PET Fill	12	RED	667148881	GRN	667148884	261
			YEL	667148882	WHT	667148885	
			BLUE	667148883			
6722	Short Plastic Handle Utility Brush, PP Fill	6	BLA	667228881	YEL	667228882	119
6723	Long Plastic Handle Utility Brush, PP Fill	6	BLA	667238881	YEL	667238882	119
6724	Long Handle Multi-purpose Cleaning Brush, PET Fill	12	RED	667248881	GRN	667248884	261
			YEL	667248882	WHT	667248885	
			BLUE	667248883			
6725	Chopping Board Cleaning Brush, PP Fill	12	RED	667258881	GRN	667258884	261
			YEL	667258882	WHT	667258885	
			BLUE	667258883	BRN	667258886	
6726	Chopping Board Cleaning Brush, PP Fill	12	RED	667268881	GRN	667268884	261
			YEL	667268882	WHT	667268885	
			BLUE	667268883	BRN	667268886	
6727	Three Heads Glass Brush	6	BLA	667278881			261
6728	Two Heads Glass Brush	6	BLA	667288881			261
6729	Standard Glass Brush Head	12	BLA	667298881			261
6732	Short Plastic Handle Utility Brush, Tampico Fill	6	BLA	667328881	YEL	667328882	119
6733	Long Plastic Handle Utility Brush, Tampico Fill	6	BLA	667338881	YEL	667338882	119
6743	Deck Brush, Tampico and PP Fill	12	BLA	667438881	YEL	667438882	120
6746	Wash Brush, PVC Fill	6	BLA	667468881	YEL	667468882	120
6747	Wash Brush, Nylon Fill	6	BLA	667478881	YEL	667478882	120
6751	Square Block Scrub Brush, PP Fill	12	BLA	667518881	YEL	667518882	120
6752	Wash Brush, PP Fill	6	BLA	667528881	YEL	667528882	120

No.	Product Name	Pack	Color	Order Code	Color	Order Code	Page
6753	Floor Scrub, Plastic Block Tampico Fill	12	BLA	667538881	YEL	667538882	120
6754	Wash Brush, Round Block, PP Fill	6	BLA	667548881	YEL	667548882	120
6755	Pointed Scrub Brush, Tampico Fill	12	BLA	667558881	YEL	667558882	120
6756	Pointed Scrub Brush, PP Fill	12	BLA	667568881	YEL	667568882	120
6757	Cleaning Brush, PP Fill	12	RED	667578881	GRN	667578884	261
			YEL	667578882	WHT	667578885	
			BLUE	667578883			
6758	Cleaning Brush, PP Fill	12	RED	667588881	GRN	667588884	261
			YEL	667588882	WHT	667588885	
			BLUE	667588883			
6759	Cleaning Brush, PP Fill	12	RED	667598881	GRN	667598884	261
			YEL	667598882	WHT	667598885	
			BLUE	667598883			
6760	Cleaning Brush, PP Fill	12	RED	667608881	GRN	667608884	261
			YEL	667608882	WHT	667608885	
			BLUE	667608883			
6761	Stainless Steel Wire Brush	12	BLA	667618881	YEL	667618882	118
6762	Condenser Cleaning Brush	12	YEL	667628881			124
6763	Three-sided Shoe Brush	1	BLA	667638881			125
6764	30cm Wire Brush	12	BLA	667648881	YEL	667648882	118
6765	Wire Brush with Scraper	12	BLA	667658881	YEL	667658882	118
6766	Square Block Scrub Brush, Palmyra Fill	12	BLA	667668881	YEL	667668882	120
6773	28cm Wire Brush	12	BLA	667738881	YEL	667738882	118
6774	Fan Duster Brush	6	BLA	667748881			124
6775	Duster Brush	6	BLA	667758881			124
6782	Tile and Grout Brush, Nylon Bristles	12	YEL	667828882			120
6783	Tile and Grout Brush, Brass Bristles	12	YEL	667838882			118
6784	Deck Brush, Plastic Block, Tampico Fill	12	BLA	667848881	YEL	667848882	120
6785	Toilet Bowl Brush Holder	6	RED	667858881	GRN	667858884	122
			YEL	667858882	WHT	667858885	
			BLUE	667858883			
6786	Iron Handle Scrub Brush, PP Fill	12	YEL	667868882			120
6787	Plastic Hand and Nail Brush, Nylon Fill	12	WHT	667878881			120
6788	Toilet Bowl Brush	12	WHT	667888881			122
6789	Tapered Toilet Bowl Brush	12	WHT	667898881			122
6790	Bath tub Brush	12	WHT	667908881			122
6791	Toilet Bowl Brush, Hardwood Handle, PP Fill	12	YEL	667918881			118
6792	Toilet Bowl Brush, Plastic Handle, PP Fill	24	WHT	667928881			118
6793	Toilet Bowl Brush Holder	24	WHT	667938881			118
6794	Toilet Bowl Brush, Plastic Handle, PP Fill	12	BLA	667948881	YEL	667948882	118
6795	Plastic Handle Bowl Brush, PP Fill	12	YEL	667958882			118
6796	Plastic Handle Bowl Brush	12	YEL	667968881			118
6797	Plastic Handle Bowl Brush	12	YEL	667978881			118
6798	8x42cm Toilet Bowl Brushes	12	WHT	667988881			118
6801	Corn Whisk Broom	12	BLUE	668018881			124
6802	Labby Broom, 100% Corn Fill	12	RED	668028881			124
6803	Corn Broom, Standard, 2.5cm Stained/Lacquered Handle	12	RED	668038881			124
6804	Corn Broom, Warehouse, 2.9cm Stained/Lacquered Handle	12	RED	668048881			124
6805	Corn Broom, Warehouse, 2.9cm Stained/Lacquered Handle	12	RED	668058881			124
6814	46cm Straight Floor Squeegee	6	BLA	668148881			128
6815	61cm Straight Floor Squeegee	6	BLA	668158881			128
6816	91cm Straight Floor Squeegee	6	BLA	668168881			128
6817	46cm Replacement Blade	6	BLA	668178881			128
6818	61cm Replacement Blade	6	BLA	668188881			128
6819	91cm Replacement Blade	6	BLA	668198881			128
6825	61cm Curved Floor Squeegee	6	BLA	668258881			128
6831	46cm Plastic Professional Squeegee with Black Dual Moss Rubber	10	RED	668318881	YEL	668318883	129, 260
			BLUE	668318882	GRN	668318884	
6841	46cm Standard Floor Squeegee	10	BLA	668418881			128
6842	56cm Standard Floor Squeegee	10	BLA	668428881			128
6843	56cm Heavy-duty Floor Squeegee	10	BLA	668438881			128
6844	76cm Heavy-duty Floor Squeegee	10	BLA	668448881			128
6851	Light Wooden Floor Sweep, PP Fill	6	LAC	668518881			116
6852	Medium Wooden Floor Sweep, PP Fill	6	LAC	668528881			116

# PRODUCT INDEX

No.	Product Name	Pack	Color	Order Code	Color	Order Code	Page
6853	Heavy-duty Wooden Floor Sweep, PP Bristles	6	LAC	668538881			117
6861	Light Wooden Floor Sweep, PP Fill	6	LAC	668618881			116
6862	Medium Wooden Floor Sweep, PP Fill	6	LAC	668628881			116
6863	Heavy-duty Wooden Floor Sweep, PP Bristles	6	LAC	668638881			117
6871	Light Wooden Floor Sweep, PP Fill	6	LAC	668718881			116
6872	Medium Wooden Floor Sweep, PP Fill	6	LAC	668728881			116
6873	Heavy-duty Wooden Floor Sweep, PP Bristles	6	LAC	668738881			117
6881	Light Wooden Floor Sweep, PP Fill	6	LAC	668818881			116
6882	Medium Wooden Floor Sweep, PP Fill	6	LAC	668828881			116
6883	Heavy-duty Wooden Floor Sweep, PP Bristles	6	LAC	668838881			117
6891	Light Wooden Floor Sweep, PP Fill	6	LAC	668918881			116
6892	Medium Wooden Floor Sweep, PP Fill	6	LAC	668928881			116
6893	Heavy-duty Wooden Floor Sweep, PP Bristles	6	LAC	668938881			117
6901	Wall Washer Kit Includes 2 Brushes	2	BLA	669018881			131
6902	Wall Washer Kit Includes 2 Microfiber Brushes	2	BLA	669028881			131
6903	Wall Washer Kit Replacement Brushes	12	WHT	669038881			131
6904	Wall Washer Kit Replacement Microfiber Brushes	12	WHT	669048881			131
6911	Predator Upright Dust Pan with Hook	6	BLA	669118881			126
6912	Predator Upright Dust Pan with Cover	6	BLA	669128881			126
6913	Predator Upright Dust Pan with Cover w/o Hook	6	BLA	669138881			126
6914	Predator Upright Dust Pan w/o Hook	6	BLA	669148881			126
6915	Predator Upright Dust Pan Hanger Bracket	6	BLA	669158881			126
6916	Predator Dry/Wet Dust Pan	4	BLA	669168881			126
6917	Predator Dry/Wet Floor Squeegee	4	BLA	669178881			126
6923	Heavy-duty Dust Pan	12	BLA	669238881			127
6924	Extra Large Dust Pan	6	BLA	669248881			127
6925	Jumbo Dust Pan	6	BLA	669258881			127
6926	Heavy-duty Dust Pan and Counter Brush	6	BLA	669268881			127
6927	Steel Heavy-duty Dust Pan	6	BLA	669278881			127
6928	Steel Heavy-duty Dust Pan	6	BLA	669288881			127
6929	Step&Sweep Dust Pan	6	GRAY	669298881			127
6930	Rotomolded Plastic Pedal	1	BLA	669308881	YEL	669308882	134, 174
6931	Deluxe Carry Caddy	6	BLA	669318881			136
6932	Two-step Folding Stepstool	3	GRAY	669328881	BLA	669328882	134, 174
			DGRAY	669328883			
6933	Movable Two-step Pedal	1	BLA	669338881	BEIG	669338882	134, 174
6934	Nozzle	12	RED	669348881	GRN	669348884	137
			YEL	669348882	WHT	669348885	
			BLUE	669348883			
6935	950 ml Spray Bottle	12	WHT	669358882			137
6936	Pneumatic Sprayer	12	WHT	669368881			137
6937	Pneumatic Sprayer	12	WHT	669378881			137
6938	Pneumatic Sprayer	12	WHT	669388881			137
6939	Toilet Pump	12	BLA	669398881			138
6940	Toilet Pump	12	BLA	669408881			138
6941	Closet Organizer/Tool Holder Kit	6	YEL	669418881	BLUE	669418883	132, 265
			RED	669418882	GRN	669418884	
6942	Closet Organizer/Tool Holder Kit	4	YEL	669428881	BLUE	669428883	132, 265
			RED	669428882	GRN	669428884	
6943	Two-step Folding Ladder	1	BLA	669438881			136, 173
6944	Three-step Folding Ladder	1	BLA	669448881			136, 173
6945	Multi-function Ladder	1	MSILV	669458881			135, 173
6946	Multi-function Ladder	1	MSILV	669468881			135, 173
6947	Spray Bottle with Trigger	12	RED	669478882			137
6948	Pedal Sanitary Bin	1	WHT	669488881	GRAY	669488882	142
6949	Pedal Sanitary Bin	4	WHT	669498881	GRAY	669498882	142
6950	Wall-mounted Sanitary Napkin Receptacle	1	WHT	669508881			142
6951	Ironing Organizer	6	WHT	669518881	BLA	669518882	133
6952	650 ml Spray Bottle	12	WHT	669528882			137
6953	Three-sided Multi-layer Storage Bag for 5021/5022/5023	2	BRN	669538881			69
6954	Large Capacity of Side Hanging Bag for 5021/5022/5023/5031	6	BRN	669548881			69
6955	Double-layer Tool Basket	3	BLA	669558881			136
6956	Toilet Brush Holder, for 6955	6	BLA	669568881			136

No.	Product Name	Pack	Color	Order Code	Color	Order Code	Page
6961	Bath Mat	4	WHT	669618881	BEIG	669618882	142
6963	Bath Mat	4	WHT	669638881	BEIG	669638882	142
6965	Bath Mat	4	WHT	669658881	BEIG	669658882	142
6966	Bin Liner Refills (15 Pieces Per Roll), for 6948	12		669668881			142
6967	Bin Liner Refills (15 Pieces Per Roll), for 6949	12		669678881			142
6968	Canvas Linen Accessory Bag for 5031	6	BRN	669688881			71, 73
6969	Fabric Mesh Linen Bag for 5031	6	BRN	669698881			71, 73
6970	Vinyl Bag for 5031	6	BRN	669708881			71
6971	Zippered Trash Bag for 5011	2	YEL	669718881			77
6972	Vinyl Bag for 5021/5022/5023	6	BRN	669728881			69
6973	Canvas Linen Accessory Bag for 5021/5022/5023	6	BRN	669738881			69, 73
6974	Fabric Mesh Linen Bag for 5021/5022/5023	6	BRN	669748881			69, 73
6975	Fabric 9-pocket Organizer for 5021/5022/5023/5031	6	BRN	669758881			69, 73
6976	Short Polyliner, for 5021/5022/5023/5031	6	BRN	669768881			69, 73
6977	Cloth/Straw Bag, for 5021/5022/5023	6	BRN	669778881			69, 73
6978	Polyliner with Side Bag, for 5011	2	YEL	669788881	GRN	669788883	77
			BLUE	669788882	RED	669788884	
6979	Large-capacity Eight-compartment Bag, for 5021/5022/5023	6	BRN	669798881			69, 73
6981	8cm Scraper	6	BLA	669818881			138
6982	4cm Scraper	6	BLA	669828881			138
6983	Heavy-duty Glove, Large	6	BLA	669838881			133
6984	Heavy-duty Glove, Xlarge	6	BLA	669848881			133
6985	Professional Kneepads	6	BLA	669858881			133
6986	Laundry Nets	12	WHT	669868881			110
6987	76-100cm Lambswool Duster with Telescoping Plastic Handle	6	GRAY	669878881			130
6988	Flexible Head Overhead Dusting Tool, Flexible Head with 152cm Aluminum Handle	6	MSILV	669888881			130
6989	Dust Mitt Off-floor Tool, Cotton	12	WHT	669898881			130
6990	Overhead Dusting Tool with Launderable Head, 130cm Extension Handle	12	GRAY	669908881			131
6991	Overhead Dusting Tool with Angled Launderable Head, 130cm Extension Handle	12	GRAY	669918881			131
6992	Overhead Dusting Tool with Launderable Head, 260cm Extension Handle	12	GRAY	669928881			131
6993	Overhead Dusting Tool Replacement Head, fits 6990/6991/6992	12	WHT	669938881			131
6994	Dust Brush, Round Block	12	BLA	669948881			124
6995	Ostrich Duster	12	LAC	669958881			130
6996	Nipper	12	BLA	669968881			138
6997	Nipper	12	BLA	669978881			138
6998	Waxed Bag (50 per bundle)	5		669988881			142
7114	Floor Sign with "Caution Wet Floor" Imprint	6	YEL	671148881			268
7121	Safety Cone Sign	5	RED	671218881			271
7122	Safety Cone Signs with "No Parking" Imprint	5	RED	671228881			271
7133	Stable Safety Sign with "Caution Wet Floor" Imprint	6	YEL	671338881			269
7142	Hanging Safety Sign with "Caution Wet Floor" Imprint	6	YEL	671428881			269
7152	Site Safety Hanging Sign with "Closed for Cleaning" Imprint	6	YEL	671528881			269
7161	Floor Safety Sign with "Repair in Progress" Imprint	6	YEL	671618881			268
7162	Floor Safety Sign with "Cleaning in Progress" Imprint	6	YEL	671628881			268
7163	Floor Safety Sign with "Out of Service" Imprint	6	YEL	671638881			268
7175	Four-sided Billboard, Printed with the Words "Caution Wet Floor"	6	YEL	671758881			268
7176	Four-sided Billboard, Printed with the Words "Cleaning in Progress"	6	YEL	671768881			268
7177	Four-sided Billboard, Printed with the Words "Out of Service"	6	YEL	671778881			268
7178	Four-sided Billboard, Printed with the Words "Repair in Progress"	6	YEL	671788881			268
7181	Movable Fence, Consisting of 16 Connecting Plates	1	YEL	671818881			270
7182	Movable Fence, Consisting of 12 Connecting Plates	1	YEL	671828881			270
7183	Movable Fence, Consisting of 8 Connecting Plates	1	YEL	671838881			270
7313	Safety Cone With "Caution, Wet Floor" Imprint	6	YEL	673138881			271
7315	Safety Cone With "No Parking" Imprint	6	YEL	673158881			271
7323	Safety Cone With "Caution, Wet Floor" Imprint	5	YEL	673238881			271

# PRODUCT INDEX

No.	Product Name	Pack	Color	Order Code	Color	Order Code	Page
7333	Pop-up Safety Cone, 50cm with "Caution, Wet Floor" Imprint	12	YEL	673338881			272
7334	Pop-up Safety Cone, 76cm with "Caution, Wet Floor" Imprint	12	YEL	673348881			272
7342	Folding Safety Cone with "Caution, Wet Floor" Imprint	12	YEL	673428881			272
7511	Barrier Chain	4	YEL	675118881			271
7512	Safety Warning Light	12	YEL	675128881			271
7521	Weight-ring for 7321/7322	1	BLA	675218881			271
8011	Kid&Cool® Youth Seat without Wheels	1	BLA	680118881	GRN	680118883	256
			PLAT	680118882	BRN	680118884	
8012	Kid&Cool® Youth Seat with Wheels	1	BLA	680128881	GRN	680128883	256
			PLAT	680128882	BRN	680128884	
8013	Tray for 8011/8012/8014	1	GRN	680138881	BLUE	680138884	256
			PLAT	680138882	BLA	680138885	
			RED	680138883	BRN	680138886	
8014	Kid&Cool® Youth Seat, RTA (Ready to Assemble) no Wheels	1	BLA	680148881	GRN	680148883	256
			PLAT	680148882	BRN	680148884	
			BLUE	680148885			
8015	Castor Kit	1		680158881			256
8016	Non-slip Feet Pad Set	1	BLA	680168881			256
8021	Heimdall Baby Changing Station	1	LPLAT	680218881			140, 260
8022	Protective Liners for Baby Changing Station	16	WHT	680228881			140, 260
8023	Heimdall Baby Changing Station	1	LPLAT	680238881			140, 260
8031	Kid&Cool® Infant Safety Seat	1	LPLAT	680318881			141, 259
8211	Bus/Utility Box	12	GRAY	682118881	WHT	682118882	254
			BRN	682118883			
8212	Bus/Utility Box	12	GRAY	682128881	WHT	682128882	254
8216	Lid for 8211/8212	12	GRAY	682168881	WHT	682168882	254
8220	Bus/Utility Box	6	GRAY	682208881	BRN	682208882	254
8221	Bus/Utility Box	6	GRAY	682218881	BRN	682218882	254
8222	Divided Bus/Utility Box	6	GRAY	682228881	BRN	682228882	254
8226	Lid for 8220/8221/8222	6	GRAY	682268881	BRN	682268882	254
8231	Cutlery Bin, 4 Compartments	12	GRAY	682318881			254
8241	Catering Disk	12	BLA	682418881	STRAN	682418882	239
8250	Round GRP Non-slip Pallet	12	BRN	682508881			239
8251	Round GRP Non-slip Pallet	12	BRN	682518881			239
8252	Round GRP Non-slip Pallet	12	BRN	682528881			239
8253	Round GRP Non-slip Pallet	12	BRN	682538881			239
8254	Round GRP Non-slip Pallet	12	BRN	682548881			239
8255	Rectangular GRP Non-slip Pallet	12	BRN	682558881			239
8256	Rectangular GRP Non-slip Pallet	12	BRN	682568881			239
8257	Rectangular GRP Non-slip Pallet	12	BRN	682578881			239
8258	Rectangular GRP Non-slip Pallet	12	BRN	682588881			239
8259	Rectangular GRP Non-slip Pallet	12	BRN	682598881			239
8260	Rectangular GRP Non-slip Pallet	12	BRN	682608881			239
8261	Pitcher	6	CLR	682618881			255
8262	Pitcher	6	CLR	682628881			255
8263	Pitcher	6	CLR	682638881			255
8264	Pitcher	6	CLR	682648881			255
8265	Cold Water Bottle	6	CLR	682658881			255
8266	Cold Water Bottle	6	CLR	682668881			255
8267	Oval GRP Non-slip Tray	6	BRN	682678881			239
8268	Oval GRP Non-slip Tray	6	BRN	682688881			239
8269	Oval GRP Non-slip Tray	6	BRN	682698881			239
8270	Round Wood Grain Non-slip Tray	12	ASH	682708881	WAL	682708882	240
8271	Round Wood Grain Non-slip Tray	12	ASH	682718881	WAL	682718882	240
8272	Rectangle Wood Grain Non-slip Tray	12	ASH	682728881	WAL	682728882	240
8273	Rectangle Wood Grain Non-slip Tray	12	ASH	682738881	WAL	682738882	240
8274	Rectangle Wood Grain Non-slip Tray	12	ASH	682748881	WAL	682748882	240
8275	Rectangle Wood Grain Non-slip Tray	12	ASH	682758881	WAL	682758882	240
8276	Oval Wood Grain Non-slip Tray	12	ASH	682768881	WAL	682768882	240
8277	Oval Wood Grain Non-slip Tray	12	ASH	682778881	WAL	682778882	240
8278	Oval Wood Grain Non-slip Tray	12	ASH	682788881	WAL	682788882	240
8279	Oval Wood Grain Non-slip Tray	12	ASH	682798881	WAL	682798882	240
8281	Round PP Non-slip Tray	12	BRN	682818881			240

No.	Product Name	Pack	Color	Order Code	Color	Order Code	Page
8282	Round PP Non-slip Tray	12	BRN	682828881			240
8283	Round PP Non-slip Tray	12	BRN	682838881			240
8284	Round PP Non-slip Tray	12	BRN	682848881			240
8285	Rectangle PP Non-slip Tray	12	BRN	682858881			240
8286	Rectangle PP Non-slip Tray	12	BRN	682868881			240
8287	Rectangle PP Non-slip Tray	12	BRN	682878881			240
8288	Rectangle PP Non-slip Tray	12	BRN	682888881			240
8311	Round Storage Container	12	STRAN	683118881			200
8312	Round Storage Container	12	STRAN	683128881			200
8313	Round Storage Container	12	STRAN	683138881			200
8314	Round Storage Container	12	STRAN	683148881			200
8315	Round Storage Container	6	STRAN	683158881			200
8316	Round Storage Container	6	STRAN	683168881			200
8317	Round Storage Container	6	STRAN	683178881			200
8318	Round Storage Container with Bail	6	STRAN	683188881			200
8321	Round Storage Container	12	WHT	683218881			200
8322	Round Storage Container	12	WHT	683228881			200
8323	Round Storage Container	12	WHT	683238881			200
8324	Round Storage Container	12	WHT	683248881			200
8325	Round Storage Container	6	WHT	683258881			200
8326	Round Storage Container	6	WHT	683268881			200
8327	Round Storage Container	6	WHT	683278881			200
8328	Round Storage Container with Bail	6	WHT	683288881			200
8331	Lid for 8311/8312/8321/8322	12	YEL	683318881			200
8332	Lid for 8313/8314/8323/8324	12	YEL	683328881	NAT	683328882	200
8333	Lid for 8315/8316/8317/8325/8326/8327	6	YEL	683338881	NAT	683338882	200
8341	Pitcher	6	CLR	683418881			255
8342	Pitcher	6	CLR	683428881			255
8343	Pitcher	6	CLR	683438881			255
8344	Pitcher	6	CLR	683448881			255
8411	Food Material Storage Bin	1	WHT	684118881			184
8412	Food Material Storage Bin	1	WHT	684128881			184
8413	Food Material Storage Bin	1	WHT	684138881			184
8414	Spoon	6	CLR	684148881			184
8415	Storage Bin Lid	1	WHT	684158881			184
8416	Storage Bin Lid	1	WHT	684168881			184
8417	Storage Bin Lid	1	WHT	684178881			184
8418	Shelf-type Raw Food Material Containers	1	WHT	684188881			185
8419	Shelf-type Raw Food Material Containers	1	WHT	684198881			185
8420	Shelf-type Raw Food Material Containers	1	WHT	684208881			185
8421	Fresh Fruits and Vegetables Storage Bin with a Lid and a Cart	1	WHT	684218881			188
8422	Fresh Fruits and Vegetables Storage Bin with a Lid and a Cart	1	WHT	684228881			188
8431	Ice Bucket	6	WHT	684318882			188
8432	Ice Bucket	6	WHT	684328882			188
8433	0.5-Cup Measuring Spoon for 8418	12	CLR	684338881			185
8434	2-Cup Measuring Spoon for 8419, 8420	6	CLR	684348881			185
8441	Condiment Dispenser with Three 0.9 L Inserts	1	BLA	684418881			255
8442	Condiment Dispenser with Four 0.7 L Inserts	1	BLA	684428881			255
8443	Condiment Dispenser with Six 0.5 L Inserts	1	BLA	684438881			255
8451	Cold Food Pan, Full Size	6	CLR	684518881			192
8452	Cold Food Pan, Full Size	6	CLR	684528881			192
8453	Cold Food Pan, Full Size	6	CLR	684538881			192
8454	Cold Food Pan, Full Size	6	CLR	684548881			192
8455	Cold Food Pan Cover with Handle, Full Size	6	CLR	684558881			193
8456	Cold Food Pan Cover with Handle and Notched, Full Size	6	CLR	684568881			193
8457	Cold Food Pan Flat Cover, Full Size	6	CLR	684578881			194
8461	Cold Food Pan, 1/2 Size	6	CLR	684618881			192
8462	Cold Food Pan, 1/2 Size	6	CLR	684628881			192
8463	Cold Food Pan, 1/2 Size	6	CLR	684638881			192
8464	Cold Food Pan, 1/2 Size	6	CLR	684648881			192
8465	Cold Food Pan Cover with Handle, 1/2 Size	6	CLR	684658881			193
8466	Cold Food Pan Cover with Handle and Notched, 1/2 Size	6	CLR	684668881			193
8467	Cold Food Pan Flat Cover, 1/2 Size	6	CLR	684678881			194
8471	Cold Food Pan, 1/3 Size	6	CLR	684718881			192

# PRODUCT INDEX

No.	Product Name	Pack	Color	Order Code	Color	Order Code	Page
8472	Cold Food Pan, 1/3 Size	6	CLR	684728881			192
8473	Cold Food Pan, 1/3 Size	6	CLR	684738881			192
8474	Cold Food Pan, 1/3 Size	6	CLR	684748881			192
8475	Cold Food Pan Cover with Handle, 1/3 Size	6	CLR	684758881			193
8476	Cold Food Pan Cover with Handle and Notched, 1/3 Size	6	CLR	684768881			193
8477	Cold Food Pan Flat Cover, 1/3 Size	6	CLR	684778881			194
8481	Cold Food Pan, 1/4 Size	6	CLR	684818881			192
8482	Cold Food Pan, 1/4 Size	6	CLR	684828881			192
8483	Cold Food Pan, 1/4 Size	6	CLR	684838881			192
8484	Cold Food Pan Cover with Handle, 1/4 Size	6	CLR	684848881			193
8485	Cold Food Pan Cover with Handle and Notched, 1/4 Size	6	CLR	684858881			193
8486	Cold Food Pan Flat Cover, 1/4 Size	6	CLR	684868881			194
8491	Cold Food Pan, 1/6 Size	6	CLR	684918881			192
8492	Cold Food Pan, 1/6 Size	6	CLR	684928881			192
8493	Cold Food Pan, 1/6 Size	6	CLR	684938881			192
8494	Cold Food Pan Cover with Handle, 1/6 Size	6	CLR	684948881			193
8495	Cold Food Pan Cover with Handle and Notched, 1/6 Size	6	CLR	684958881			193
8496	Cold Food Pan Flat Cover, 1/6 Size	6	CLR	684968881			194
8497	Cold Food Pan, 1/9 Size	6	CLR	684978881			192
8498	Cold Food Pan, 1/9 Size	6	CLR	684988881			192
8499	Cold Food Pan Flat Cover, 1/9 Size	6	CLR	684998881			194
8501	Cold Drain Tray, Full Size	6	CLR	685018881			194
8502	Cold Drain Tray, 1/2 Size	6	CLR	685028881			194
8503	Cold Drain Tray, 1/3 Size	6	CLR	685038881			194
8504	Cold Drain Tray, 1/4 Size	6	CLR	685048881			194
8505	Cold Drain Tray, 1/6 Size	6	CLR	685058881			194
8506	Hot Drain Tray, Full Size	6	AMBR	685068881			194
8507	Hot Drain Tray, 1/2 Size	6	AMBR	685078881			194
8508	Hot Drain Tray, 1/3 Size	6	AMBR	685088881			194
8509	Hot Drain Tray, 1/4 Size	6	AMBR	685098881			194
8510	Hot Drain Tray, 1/6 Size	6	AMBR	685108881			194
8511	Scraper	36	WHT	685118881			242
8512	Scraper	36	WHT	685128881			242
8513	Scraper	36	WHT	685138881			242
8514	Ice Scraper	36	WHT	685148881			242
8515	Spoon-shaped Scraper	36	WHT	685158881			242
8516	Spoon-shaped Scraper	36	WHT	685168881			242
8517	Spoon-shaped Scraper	36	WHT	685178881			242
8520	Chopping Board	6	RED	685208881	GRN	685208884	243
			YEL	685208882	BRN	685208885	
			BLUE	685208883	WHT	685208886	
8521	Chopping Board	6	RED	685218881	GRN	685218884	243
			YEL	685218882	BRN	685218885	
			BLUE	685218883	WHT	685218886	
8522	The Chopping Board Set (6 colors)	1		685228881			243
8523	Chopping Board Holder	1	MSILV	685238881			243
8524	Chopping Board	6	RED	685248881	GRN	685248884	243
			YEL	685248882	BRN	685248885	
			BLUE	685248883	WHT	685248886	
8525	Chopping Board	6	RED	685258881	GRN	685258884	243
			YEL	685258882	BRN	685258885	
			BLUE	685258883	WHT	685258886	
8526	Chopping Board	6	RED	685268881	GRN	685268884	243
			YEL	685268882	BRN	685268885	
			BLUE	685268883	WHT	685268886	
8527	Chopping Board	6	RED	685278881	GRN	685278884	243
			YEL	685278882	BRN	685278885	
			BLUE	685278883	WHT	685278886	
8528	Chopping Board	6	RED	685288881	GRN	685288884	243
			YEL	685288882	BRN	685288885	
			BLUE	685288883	WHT	685288886	
8529	Chopping Board Holder	1	BLA	685298881			243
8613	Food Storage Rack / Cart	1	OWHT	686138881	BLA	686138882	230
8614	Food Storage Rack / Cart	1	OWHT	686148881	BLA	686148882	230

No.	Product Name	Pack	Color	Order Code	Color	Order Code	Page
8615	Food Storage Rack/Cart	1	OWHT	686158881	BLA	686158882	230
8621	Food Storage Rack	1	OWHT	686218881	BLA	686218882	230
8622	Food Storage Rack	1	OWHT	686228881	BLA	686228882	230
8651	Adjustable Tray&Dish Cart	1	DBRN	686518881	BLA	686518883	231
			SGRAY	686518882			
8652	Column	2	DBRN	686528881	BLA	686528883	231
			SGRAY	686528882			
8653	Dust Cover	2	CLR	686538881			231
8701	Cold Drink Coolbox	1	RED	687018881			219
8702	Cold Drink Coolbox	1	RED	687028881			219
8703	Cold Drink Coolbox	1	RED	687038881			219
8711	Insulated Box	1	RED	687118881			218
8712	Insulated Box	1	RED	687128881			218
8713	Insulated Box	1	RED	687138881			218
8714	Insulated Box	1	RED	687148881			218
8715	Pull Rod Type insulated Box	1	RED	687158881			218
8721	Insulated Bottle	1	RED	687218881			219
8731	GN 1/1 Cold Food Pan - 65mm	6	CLR	687318881			197
8732	GN 1/1 Cold Food Pan - 100mm	6	CLR	687328881			197
8733	GN 1/1 Cold Food Pan - 150mm	6	CLR	687338881			197
8734	GN 1/1 Cold Food Pan - 200mm	6	CLR	687348881			197
8735	GN 1/1 Lids with Handle	6	CLR	687358881			198
8736	GN 1/1 Lids with Entry and Handle	6	CLR	687368881			198
8737	GN 1/1 Flat Lid	6	CLR	687378881			199
8741	GN 1/2 Cold Food Pan - 65mm	6	CLR	687418881			197
8742	GN 1/2 Cold Food Pan - 100mm	6	CLR	687428881			197
8743	GN 1/2 Cold Food Pan - 150mm	6	CLR	687438881			197
8744	GN 1/2 Cold Food Pan - 200mm	6	CLR	687448881			197
8745	GN 1/2 Lids with Handle	6	CLR	687458881			198
8746	GN 1/2 Lids with Entry and Handle	6	CLR	687468881			198
8747	GN 1/2 Flat Lid	6	CLR	687478881			199
8751	GN 1/3 Cold Food Pan - 65mm	6	CLR	687518881			197
8752	GN 1/3 Cold Food Pan - 100mm	6	CLR	687528881			197
8753	GN 1/3 Cold Food Pan - 150mm	6	CLR	687538881			197
8754	GN 1/3 Cold Food Pan - 200mm	6	CLR	687548881			197
8755	GN 1/3 Lids with Handle	6	CLR	687558881			198
8756	GN 1/3 Lids with Entry and Handle	6	CLR	687568881			198
8757	GN 1/3 Flat Lid	6	CLR	687578881			199
8761	GN 1/4 Cold Food Pan - 65mm	6	CLR	687618881			197
8762	GN 1/4 Cold Food Pan - 100mm	6	CLR	687628881			197
8763	GN 1/4 Cold Food Pan - 150mm	6	CLR	687638881			197
8764	GN 1/4 Lids with Handle	6	CLR	687648881			198
8765	GN 1/4 Lids with Entry and Handle	6	CLR	687658881			198
8766	GN 1/4 Flat Lid	6	CLR	687668881			199
8771	GN 1/6 Cold Food Pan - 65mm	6	CLR	687718881			197
8772	GN 1/6 Cold Food Pan - 100mm	6	CLR	687728881			197
8773	GN 1/6 Cold Food Pan - 150mm	6	CLR	687738881			197
8774	GN 1/6 Lids with Handle	6	CLR	687748881			198
8775	GN 1/6 Lids with Entry and Handle	6	CLR	687758881			198
8776	GN 1/6 Flat Lid	6	CLR	687768881			199
8781	GN 1/9 Cold Food Pan - 65mm	6	CLR	687818881			197
8782	GN 1/9 Cold Food Pan - 100mm	6	CLR	687828881			197
8783	GN 1/9 Flat Lid	6	CLR	687838881			199
8791	GN 1/1 Drain Trays	6	CLR	687918881			199
8792	GN 1/2 Drain Trays	6	CLR	687928881			199
8793	GN 1/3 Drain Trays	6	CLR	687938881			199
8794	GN 1/4 Drain Trays	6	CLR	687948881			199
8795	GN 1/6 Drain Trays	6	CLR	687958881			199
8811	Hot Food Pan, Full Size	6	AMBR	688118881	BLA	688118882	192
8812	Hot Food Pan, Full Size	6	AMBR	688128881	BLA	688128882	192
8813	Hot Food Pan, Full Size	6	AMBR	688138881	BLA	688138882	192
8814	Hot Food Pan Cover with Handle, Full Size	6	AMBR	688148881			193
8815	Hot Food Pan Cover with Handle and Notched, Full Size	6	AMBR	688158881			193
8816	Hot Food Pan Flat Cover, Full Size	6	AMBR	688168881			194

# PRODUCT INDEX

No.	Product Name	Pack	Color	Order Code	Color	Order Code	Page
8821	Hot Food Pan, 1/2 Size	6	AMBR	688218881	BLA	688218882	192
8822	Hot Food Pan, 1/2 Size	6	AMBR	688228881	BLA	688228882	192
8823	Hot Food Pan, 1/2 Size	6	AMBR	688238881	BLA	688238882	192
8824	Hot Food Pan Cover with Handle, 1/2 Size	6	AMBR	688248881			193
8825	Hot Food Pan Cover with Handle and Notched, 1/2 Size	6	AMBR	688258881			193
8826	Hot Food Pan Flat Cover, 1/2 Size	6	AMBR	688268881			194
8831	Hot Food Pan, 1/3 Size	6	AMBR	688318881	BLA	688318882	192
8832	Hot Food Pan, 1/3 Size	6	AMBR	688328881	BLA	688328882	192
8833	Hot Food Pan, 1/3 Size	6	AMBR	688338881	BLA	688338882	192
8834	Hot Food Pan Cover with Handle, 1/3 Size	6	AMBR	688348881			193
8835	Hot Food Pan Cover with Handle and Notched, 1/3 Size	6	AMBR	688358881			193
8836	Hot Food Pan Flat Cover, 1/3 Size	6	AMBR	688368881			194
8841	Hot Food Pan, 1/4 Size	6	AMBR	688418881	BLA	688418882	192
8842	Hot Food Pan, 1/4 Size	6	AMBR	688428881	BLA	688428882	192
8843	Hot Food Pan, 1/4 Size	6	AMBR	688438881	BLA	688438882	192
8844	Hot Food Pan Cover with Handle, 1/4 Size	6	AMBR	688448881			193
8845	Hot Food Pan Cover with Handle and Notched, 1/4 Size	6	AMBR	688458881			193
8846	Hot Food Pan Flat Cover, 1/4 Size	6	AMBR	688468881			194
8851	Hot Food Pan, 1/6 Size	6	AMBR	688518881	BLA	688518882	192
8852	Hot Food Pan, 1/6 Size	6	AMBR	688528881	BLA	688528882	192
8853	Hot Food Pan, 1/6 Size	6	AMBR	688538881	BLA	688538882	192
8854	Hot Food Pan Cover with Handle, 1/6 Size	6	AMBR	688548881			193
8855	Hot Food Pan Cover with Handle and Notched, 1/6 Size	6	AMBR	688558881			193
8856	Hot Food Pan Flat Cover, 1/6 Size	6	AMBR	688568881			194
8861	Hot Food Pan, 1/9 Size	6	AMBR	688618881	BLA	688618882	192
8862	Hot Food Pan, 1/9 Size	6	AMBR	688628881	BLA	688628882	192
8863	Hot Food Pan Flat Cover, 1/9 Size	6	AMBR	688638881			194
8870	GN1/2 Excebox® 25.7cm Height	1	BLA	688708881			227
8871	GN1/2 Excebox® 31.6cm Height	1	BLA	688718881			227
8872	GN1/2 Excebox® with Carrying Handle	1	BLA	688728881			227
8873	GN1/1 Excebox® 25.7cm Height	1	BLA	688738881			227
8874	GN1/1 Excebox® 31.6cm Height	1	BLA	688748881			227
8875	GN1/1 Excebox® Stackable	1	BLA	688758881			227
8876	GN1/1 Excebox® with Ergonomic Handles	1	BLA	688768881			227
8877	6040 Excebox® 27.0cm Height	1	BLA	688778881			227
8878	6040 Excebox® 37.0cm Height	1	BLA	688788881			227
8879	Front-loading Excebox® 47.5cm Height	1	BLA	688798881			225
8880	Front-loading Excebox® 62.5cm Height	1	BLA	688808881			225
8881	Front-loading Excebox® without Rail	1	BLA	688818881			225
8882	Front-loading Excebox® with 6 Rails	1	BLA	688828881			225
8883	Front-loading Excebox® with 9 Rails	1	BLA	688838881			225
8884	Plastic Labels	1	N/A	688848881			228
8885	GN1/2 Cooler	1	BLUE	688858881			228
8886	GN1/1 Cooler	1	BLUE	688868881			228
8887	GN1/1 Warmer	1	RED	688878881			228
8888	Totes Trolley	1	BLA	688888881			157, 228
8889	Totes Trolley	1	BLA	688898881			157, 228
8890	Adjustable Rail Kit	1	SS	688908881			228
8891	GN1/2 Lid for Top-loading Excebox®	6	BLA	688918881	RED	688918882	228
			YEL	688918883	BLUE	688918884	
			GRN	688918885	ORA	688918886	
8892	GN 1/1 Lid for Top-loading Excebox®	6	BLA	688928881	RED	688928882	228
			YEL	688928883	BLUE	688928884	
			GRN	688928885	ORA	688928886	
8911	GN 1/1 Cold Food Pan-65mm	6	CLR	689118881			197
8912	GN 1/1 Cold Food Pan-100mm	6	CLR	689128881			197
8913	GN 1/1 Cold Food Pan-150mm	6	CLR	689138881			197
8914	GN 1/1 Cold Food Pan-200mm	6	CLR	689148881			197
8915	GN 1/1 Lids with Handle	6	CLR	689158881			198
8916	GN 1/1 Lids with Entry and Handle	6	CLR	689168881			198
8917	GN 1/1 Flat Lid	6	CLR	689178881			199
8921	GN 1/2 Cold Food Pan-65mm	6	CLR	689218881			197
8922	GN 1/2 Cold Food Pan-100mm	6	CLR	689228881			197
8923	GN 1/2 Cold Food Pan-150mm	6	CLR	689238881			197

No.	Product Name	Pack	Color	Order Code	Color	Order Code	Page
8924	GN 1/2 Cold Food Pan-200mm	6	CLR	689248881			197
8925	GN 1/2 Lids with Handle	6	CLR	689258881			198
8926	GN 1/2 Lids with Entry and Handle	6	CLR	689268881			198
8927	GN 1/2 Flat Lid	6	CLR	689278881			199
8931	GN 1/3 Cold Food Pan-65mm	6	CLR	689318881			197
8932	GN 1/3 Cold Food Pan-100mm	6	CLR	689328881			197
8933	GN 1/3 Cold Food Pan-150mm	6	CLR	689338881			197
8934	GN 1/3 Cold Food Pan-200mm	6	CLR	689348881			197
8935	GN 1/3 Lids with Handle	6	CLR	689358881			198
8936	GN 1/3 Lids with Entry and Handle	6	CLR	689368881			198
8937	GN 1/3 Flat Lid	6	CLR	689378881			199
8941	GN 1/4 Cold Food Pan-65mm	6	CLR	689418881			197
8942	GN 1/4 Cold Food Pan-100mm	6	CLR	689428881			197
8943	GN 1/4 Cold Food Pan-150mm	6	CLR	689438881			197
8944	GN 1/4 Lids with Handle	6	CLR	689448881			198
8945	GN 1/4 Lids with Entry and Handle	6	CLR	689458881			198
8946	GN 1/4 Flat Lid	6	CLR	689468881			199
8951	GN 1/6 Cold Food Pan-65mm	6	CLR	689518881			197
8952	GN 1/6 Cold Food Pan-100mm	6	CLR	689528881			197
8953	GN 1/6 Cold Food Pan-150mm	6	CLR	689538881			197
8954	GN 1/6 Lids with Handle	6	CLR	689548881			198
8955	GN 1/6 Lids with Entry and Handle	6	CLR	689558881			198
8956	GN 1/6 Flat Lid	6	CLR	689568881			199
8961	GN 1/9 Cold Food Pan-65mm	6	CLR	689618881			197
8962	GN 1/9 Cold Food Pan-100mm	6	CLR	689628881			197
8963	GN 1/9 Flat Lid	6	CLR	689638881			199
8971	GN 1/1 Drain Trays	6	CLR	689718881			199
8972	GN 1/2 Drain Trays	6	CLR	689728881			199
8973	GN 1/3 Drain Trays	6	CLR	689738881			199
8974	GN 1/4 Drain Trays	6	CLR	689748881			199
8975	GN 1/6 Drain Trays	6	CLR	689758881			199
9000	Cupcomb® Half Size Open Extender	12	LGRAY	690008881			250
9001	Cupcomb® Half Size Cover	1	WHT	690018887			251
9002	Cupcomb® 8 Compartment Half Size Flatware Basket	6	LGRAY	690028887			250
9003	Cupcomb® 8 Compartment Half Size Flatware Basket with Handle	6	LGRAY	690038881			250
9008	Cupcomb® Full Size Cover	1	WHT RED	690088881 690088882	GRN	690088885	251
9009	Cupcomb® Full Size Open Extender	12	LGRAY	690098881			250
9080	Cupcomb® Half Size Glass Racks - 8 Compartment - Base Rack	6	LGRAY	690808881	SGRN	690808882	247
9081	Cupcomb® Half Size Glass Racks - 8 Compartment - Base Rack with 1 Extender	5	N/A	690818881			247
9082	Cupcomb® Half Size Glass Racks - 8 Compartment - Base Rack with 2 Extender	4	N/A	690828881			247
9083	Cupcomb® Half Size Glass Racks - 8 Compartment - Base Rack with 3 Extender	3	N/A	690838881			247
9084	Cupcomb® Half Size Glass Racks - 8 Compartment - Base Rack with 4 Extender	2	N/A	690848881			247
9085	Cupcomb® Half Size Glass Racks - 8 Compartment - Base Rack with 5 Extender	2	N/A	690858881			247
9086	Cupcomb® Half Size Glass Racks - 8 Compartment - Base Rack with 6 Extender	2	N/A	690868881			247
9089	Cupcomb® 8 Compartment Half Size Extender	12	LGRAY	690898881			250
9090	Cupcomb® Full Size Glass Racks - 9 Compartment - Base Rack	6	LGRAY	690908881	RBRN	690908882	245
9091	Cupcomb® Full Size Glass Racks - 9 Compartment - Base Rack with 1 Extender	5	N/A	690918881			245
9092	Cupcomb® Full Size Glass Racks - 9 Compartment - Base Rack with 2 Extender	4	N/A	690928881			245
9093	Cupcomb® Full Size Glass Racks - 9 Compartment - Base Rack with 3 Extender	3	N/A	690938881			245
9094	Cupcomb® Full Size Glass Racks - 9 Compartment - Base Rack with 4 Extender	2	N/A	690948881			245
9095	Cupcomb® Full Size Glass Racks - 9 Compartment - Base Rack with 5 Extender	2	N/A	690958881			245
9096	Cupcomb® Full Size Glass Racks - 9 Compartment - Base Rack with 6 Extender	2	N/A	690968881			245

# PRODUCT INDEX

No.	Product Name	Pack	Color	Order Code	Color	Order Code	Page
9099	Cupcomb® 9 Compartment Full Size Extender	12	LGRAY	690998881			250
9100	Cupcomb® Half Size Glass Racks - 10 Compartment - Base Rack	6	LGRAY	691008881	IND	691008882	247
9101	Cupcomb® Half Size Glass Racks - 10 Compartment - Base Rack with 1 Extender	5	N/A	691018881			247
9102	Cupcomb® Half Size Glass Racks - 10 Compartment - Base Rack with 2 Extender	4	N/A	691028881			247
9103	Cupcomb® Half Size Glass Racks - 10 Compartment - Base Rack with 3 Extender	3	N/A	691038881			247
9104	Cupcomb® Half Size Glass Racks - 10 Compartment - Base Rack with 4 Extender	2	N/A	691048881			247
9105	Cupcomb® Half Size Glass Racks - 10 Compartment - Base Rack with 5 Extender	2	N/A	691058881			247
9106	Cupcomb® Half Size Glass Racks - 10 Compartment - Base Rack with 6 Extender	2	N/A	691068881			247
9109	Cupcomb® 10 Compartment Half Size Extender	12	LGRAY	691098881			250
9160	Cupcomb® Full Size Glass Racks - 16 Compartment - Base Rack	6	LGRAY	691608881	SGRN	691608882	245
9161	Cupcomb® Full Size Glass Racks - 16 Compartment - Base Rack with 1 Extender	5	N/A	691618881			245
9162	Cupcomb® Full Size Glass Racks - 16 Compartment - Base Rack with 2 Extender	4	N/A	691628881			245
9163	Cupcomb® Full Size Glass Racks - 16 Compartment - Base Rack with 3 Extender	3	N/A	691638881			245
9164	Cupcomb® Full Size Glass Racks - 16 Compartment - Base Rack with 4 Extender	2	N/A	691648881			245
9165	Cupcomb® Full Size Glass Racks - 16 Compartment - Base Rack with 5 Extender	2	N/A	691658881			245
9166	Cupcomb® Full Size Glass Racks - 16 Compartment - Base Rack with 6 Extender	2	N/A	691668881			245
9169	Cupcomb® 16 Compartment Full Size Extender	12	LGRAY	691698881			250
9170	Cupcomb® Half Size Glass Racks - 17 Compartment - Base Rack	6	LGRAY	691708881	LRED	691708882	247
9171	Cupcomb® Half Size Glass Racks - 17 Compartment - Base Rack with 1 Extender	5	N/A	691718881			247
9172	Cupcomb® Half Size Glass Racks - 17 Compartment - Base Rack with 2 Extender	4	N/A	691728881			247
9173	Cupcomb® Half Size Glass Racks - 17 Compartment - Base Rack with 3 Extender	3	N/A	691738881			247
9174	Cupcomb® Half Size Glass Racks - 17 Compartment - Base Rack with 4 Extender	2	N/A	691748881			247
9175	Cupcomb® Half Size Glass Racks - 17 Compartment - Base Rack with 5 Extender	2	N/A	691758881			247
9176	Cupcomb® Half Size Glass Racks - 17 Compartment - Base Rack with 6 Extender	2	N/A	691768881			247
9179	Cupcomb® 17 Compartment Half Size Extender	12	LGRAY	691798881			250
9200	Cupcomb® Full Size Glass Racks - 20 Compartment - Base Rack	6	LGRAY	692008881	GRAY	692008882	245
9201	Cupcomb® Full Size Glass Racks - 20 Compartment - Base Rack with 1 Extender	5	N/A	692018881			245
9202	Cupcomb® Full Size Glass Racks - 20 Compartment - Base Rack with 2 Extender	4	N/A	692028881			245
9203	Cupcomb® Full Size Glass Racks - 20 Compartment - Base Rack with 3 Extender	3	N/A	692038881			245
9204	Cupcomb® Full Size Glass Racks - 20 Compartment - Base Rack with 4 Extender	2	N/A	692048881			245
9205	Cupcomb® Full Size Glass Racks - 20 Compartment - Base Rack with 5 Extender	2	N/A	692058881			245
9206	Cupcomb® Full Size Glass Racks - 20 Compartment - Base Rack with 6 Extender	2	N/A	692068881			245
9209	Cupcomb® 20 Compartment Full Size Extender	12	LGRAY	692098881			250
9250	Cupcomb® Full Size Glass Racks - 25 Compartment - Base Rack	6	LGRAY	692508881	IND	692508882	246
9251	Cupcomb® Full Size Glass Racks - 25 Compartment - Base Rack with 1 Extender	5	N/A	692518881			246
9252	Cupcomb® Full Size Glass Racks - 25 Compartment - Base Rack with 2 Extender	4	N/A	692528881			246
9253	Cupcomb® Full Size Glass Racks - 25 Compartment - Base Rack with 3 Extender	3	N/A	692538881			246
9254	Cupcomb® Full Size Glass Racks - 25 Compartment - Base Rack with 4 Extender	2	N/A	692548881			246
9255	Cupcomb® Full Size Glass Racks - 25 Compartment - Base Rack with 5 Extender	2	N/A	692558881			246

No.	Product Name	Pack	Color	Order Code	Color	Order Code	Page
9256	Cupcomb® Full Size Glass Racks - 25 Compartment - Base Rack with 6 Extender	2	N/A	692568881			246
9259	Cupcomb® 25 Compartment Full Size Extender	12	LGRAY	692598881			250
9300	Cupcomb® Full Size Glass Racks - 30 Compartment - Base Rack	6	LGRAY	693008881	YEL	693008882	246
9301	Cupcomb® Full Size Glass Racks - 30 Compartment - Base Rack with 1 Extender	5	N/A	693018881			246
9302	Cupcomb® Full Size Glass Racks - 30 Compartment - Base Rack with 2 Extender	4	N/A	693028881			246
9303	Cupcomb® Full Size Glass Racks - 30 Compartment - Base Rack with 3 Extender	3	N/A	693038881			246
9304	Cupcomb® Full Size Glass Racks - 30 Compartment - Base Rack with 4 Extender	2	N/A	693048881			246
9305	Cupcomb® Full Size Glass Racks - 30 Compartment - Base Rack with 5 Extender	2	N/A	693058881			246
9306	Cupcomb® Full Size Glass Racks - 30 Compartment - Base Rack with 6 Extender	2	N/A	693068881			246
9309	Cupcomb® 30 Compartment Full Size Extender	12	LGRAY	693098881			250
9360	Cupcomb® Full Size Glass Racks - 36 Compartment - Base Rack	6	LGRAY	693608881	LRED	693608882	246
9361	Cupcomb® Full Size Glass Racks - 36 Compartment - Base Rack with 1 Extender	5	N/A	693618881			246
9362	Cupcomb® Full Size Glass Racks - 36 Compartment - Base Rack with 2 Extender	4	N/A	693628881			246
9363	Cupcomb® Full Size Glass Racks - 36 Compartment - Base Rack with 3 Extender	3	N/A	693638881			246
9364	Cupcomb® Full Size Glass Racks - 36 Compartment - Base Rack with 4 Extender	2	N/A	693648881			246
9365	Cupcomb® Full Size Glass Racks - 36 Compartment - Base Rack with 5 Extender	2	N/A	693658881			246
9366	Cupcomb® Full Size Glass Racks - 36 Compartment - Base Rack with 6 Extender	2	N/A	693668881			246
9369	Cupcomb® 36 Compartment Full Size Extender	12	LGRAY	693698881			250
9490	Cupcomb® Full Size Glass Racks - 49 Compartment - Base Rack	6	LGRAY	694908881	LBEIG	694908882	246
9491	Cupcomb® Full Size Glass Racks - 49 Compartment - Base Rack with 1 Extender	5	N/A	694918881			246
9492	Cupcomb® Full Size Glass Racks - 49 Compartment - Base Rack with 2 Extender	4	N/A	694928881			246
9493	Cupcomb® Full Size Glass Racks - 49 Compartment - Base Rack with 3 Extender	3	N/A	694938881			246
9494	Cupcomb® Full Size Glass Racks - 49 Compartment - Base Rack with 4 Extender	2	N/A	694948881			246
9495	Cupcomb® Full Size Glass Racks - 49 Compartment - Base Rack with 5 Extender	2	N/A	694958881			246
9496	Cupcomb® Full Size Glass Racks - 49 Compartment - Base Rack with 6 Extender	2	N/A	694968881			246
9499	Cupcomb® 49 Compartment Full Size Extender	12	LGRAY	694998881			250
9600	Cupcomb® Base Rack - Full Size - Base Rack	6	LGRAY	696008881			248
9601	Cupcomb® Base Rack - Full Size - Base Rack with 1 Extender	5	LGRAY	696018881			248
9602	Cupcomb® Base Rack - Full Size - Base Rack with 2 Extender	4	LGRAY	696028881			248
9603	Cupcomb® Base Rack - Full Size - Base Rack with 3 Extender	3	LGRAY	696038881			248
9610	Cupcomb® Base Rack - Half Size - Base Rack	6	LGRAY	696108881			248
9611	Cupcomb® Base Rack - Half Size - Base Rack with 1 Extender	5	LGRAY	696118881			248
9612	Cupcomb® Base Rack - Half Size - Base Rack with 2 Extender	4	LGRAY	696128881			248
9613	Cupcomb® Base Rack - Half Size - Base Rack with 3 Extender	3	LGRAY	696138881			248
9620	Cupcomb® 5 × 9 Peg Rack	6	LGRAY	696208881			249
9621	Cupcomb® 5 × 9 Peg Rack with 1 Extender	5	LGRAY	696218881			249
9630	Cupcomb® 9 × 9 Peg Rack	6	LGRAY	696308881			249
9631	Cupcomb® 9 × 9 Peg Rack with 1 Extender	5	LGRAY	696318881			249
9640	Cupcomb® Open End Tray Rack	6	LGRAY	696408881			249
9650	Cupcomb® Flatware Rack - Full Size	6	LGRAY	696508881			248
9651	Cupcomb® Flatware Rack - Half Size	6	LGRAY	696518881			248
9901	Label Clip - Beer	12	WHT	699018881			251
9902	Label Clip - Beer Mug	12	WHT	699028881			251
9903	Label Clip - Brandy	12	WHT	699038881			251
9904	Label Clip - Champagne	12	WHT	699048881			251
9905	Label Clip - Champagne Mug	12	WHT	699058881			251
9906	Label Clip - Coffee Mug	12	WHT	699068881			251
9907	Label Clip - Colline	12	WHT	699078881			251

# PRODUCT INDEX

No.	Product Name	Pack	Color	Order Code	Color	Order Code	Page
9908	Label Clip - Cordial	12	WHT	699088881			251
9909	Label Clip - Creamer	12	WHT	699098881			251
9910	Label Clip - Cup	12	WHT	699108881			251
9911	Label Clip - Decanter	12	WHT	699118881			251
9912	Label Clip - Flatware	12	WHT	699128881			251
9913	Label Clip - Goblet	12	WHT	699138881			251
9914	Label Clip - Grande	12	WHT	699148881			251
9915	Label Clip - Hi-Ball	12	WHT	699158881			251
9916	Label Clip - Hurricane	12	WHT	699168881			251
9917	Label Clip - Iced Tea	12	WHT	699178881			251
9918	Label Clip - Irish Coffee	12	WHT	699188881			251
9919	Label Clip - Juice	12	WHT	699198881			251
9920	Label Clip - Margarita	12	WHT	699208881			251
9921	Label Clip - Martini	12	WHT	699218881			251
9922	Label Clip - Old Fashion	12	WHT	699228881			251
9923	Label Clip - Pilsner	12	WHT	699238881			251
9924	Label Clip - Red Wine	12	WHT	699248881			251
9925	Label Clip - Rocks (Footed)	12	WHT	699258881			251
9926	Label Clip - Rocks (Tumbler)	12	WHT	699268881			251
9927	Label Clip - Sherry	12	WHT	699278881			251
9928	Label Clip - Shot Glass	12	WHT	699288881			251
9929	Label Clip - Sorbet	12	WHT	699298881			251
9930	Label Clip - Water (Footed)	12	WHT	699308881			251
9931	Label Clip - Water (Tumbler)	12	WHT	699318881			251
9932	Label Clip - White Wine	12	WHT	699328881			251
9933	Label Clip - Wine	12	WHT	699338881			251
9934	Label Clip - Port	12	WHT	699348881			251
AE142464	Firmgre® 4-Shelf Stationary Extension Kit - W360 x L610 x H1630mm	1	SGRAY	602078881			208
AE142472	Firmgre® 4-Shelf Stationary Extension Kit - W360 x L610 x H1830mm	1	SGRAY	602088881			208
AE142484	Firmgre® 4-Shelf Stationary Extension Kit - W360 x L610 x H2140mm	1	SGRAY	602098881			208
AE143064	Firmgre® 4-Shelf Stationary Extension Kit - W360 x L760 x H1630mm	1	SGRAY	602108881			208
AE143072	Firmgre® 4-Shelf Stationary Extension Kit - W360 x L760 x H1830mm	1	SGRAY	602118881			208
AE143084	Firmgre® 4-Shelf Stationary Extension Kit - W360 x L760 x H2140mm	1	SGRAY	602128881			208
AE143664	Firmgre® 4-Shelf Stationary Extension Kit - W360 x L910 x H1630mm	1	SGRAY	602138881			208
AE143672	Firmgre® 4-Shelf Stationary Extension Kit - W360 x L910 x H1830mm	1	SGRAY	602148881			208
AE143684	Firmgre® 4-Shelf Stationary Extension Kit - W360 x L910 x H2140mm	1	SGRAY	602158881			208
AE144264	Firmgre® 4-Shelf Stationary Extension Kit - W360 x L1070 x H1630mm	1	SGRAY	602168881			208
AE144272	Firmgre® 4-Shelf Stationary Extension Kit - W360 x L1070 x H1830mm	1	SGRAY	602178881			208
AE144284	Firmgre® 4-Shelf Stationary Extension Kit - W360 x L1070 x H2140mm	1	SGRAY	602188881			208
AE144864	Firmgre® 4-Shelf Stationary Extension Kit - W360 x L1220 x H1630mm	1	SGRAY	602198881			208
AE144872	Firmgre® 4-Shelf Stationary Extension Kit - W360 x L1220 x H1830mm	1	SGRAY	602208881			208
AE144884	Firmgre® 4-Shelf Stationary Extension Kit - W360 x L1220 x H2140mm	1	SGRAY	602218881			208
AE145464	Firmgre® 4-Shelf Stationary Extension Kit - W360 x L1380 x H1630mm	1	SGRAY	602228881			208
AE145472	Firmgre® 4-Shelf Stationary Extension Kit - W360 x L1380 x H1830mm	1	SGRAY	602238881			208
AE145484	Firmgre® 4-Shelf Stationary Extension Kit - W360 x L1380 x H2140mm	1	SGRAY	602248881			208
AE146064	Firmgre® 4-Shelf Stationary Extension Kit - W360 x L1530 x H1630mm	1	SGRAY	602258881			208
AE146072	Firmgre® 4-Shelf Stationary Extension Kit - W360 x L1530 x H1830mm	1	SGRAY	602268881			208
AE146084	Firmgre® 4-Shelf Stationary Extension Kit - W360 x L1530 x H2140mm	1	SGRAY	602278881			208

No.	Product Name	Pack	Color	Order Code	Color	Order Code	Page
AE147264	Firmgre® 4-Shelf Stationary Extension Kit - W360 x L1830 x H1630mm	1	SGRAY	602288881			208
AE147272	Firmgre® 4-Shelf Stationary Extension Kit - W360 x L1830 x H1830mm	1	SGRAY	602298881			208
AE147284	Firmgre® 4-Shelf Stationary Extension Kit - W360 x L1830 x H2140mm	1	SGRAY	602308881			208
AE147864	Firmgre® 4-Shelf Stationary Extension Kit - W360 x L1980 x H1630mm	1	SGRAY	602318881			208
AE147872	Firmgre® 4-Shelf Stationary Extension Kit - W360 x L1980 x H1830mm	1	SGRAY	602328881			208
AE147884	Firmgre® 4-Shelf Stationary Extension Kit - W360 x L1980 x H2140mm	1	SGRAY	602338881			208
AE182464	Firmgre® 4-Shelf Stationary Extension Kit - W460 x L610 x H1630mm	1	SGRAY	602618881			208
AE182472	Firmgre® 4-Shelf Stationary Extension Kit - W460 x L610 x H1830mm	1	SGRAY	602628881			208
AE182484	Firmgre® 4-Shelf Stationary Extension Kit - W460 x L610 x H2140mm	1	SGRAY	602638881			208
AE183064	Firmgre® 4-Shelf Stationary Extension Kit - W460 x L760 x H1630mm	1	SGRAY	602648881			208
AE183072	Firmgre® 4-Shelf Stationary Extension Kit - W460 x L760 x H1830mm	1	SGRAY	602658881			208
AE183084	Firmgre® 4-Shelf Stationary Extension Kit - W460 x L760 x H2140mm	1	SGRAY	602668881			208
AE183664	Firmgre® 4-Shelf Stationary Extension Kit - W460 x L910 x H1630mm	1	SGRAY	602678881			208
AE183672	Firmgre® 4-Shelf Stationary Extension Kit - W460 x L910 x H1830mm	1	SGRAY	602688881			208
AE183684	Firmgre® 4-Shelf Stationary Extension Kit - W460 x L910 x H2140mm	1	SGRAY	602698881			208
AE184264	Firmgre® 4-Shelf Stationary Extension Kit - W460 x L1070 x H1630mm	1	SGRAY	602708881			208
AE184272	Firmgre® 4-Shelf Stationary Extension Kit - W460 x L1070 x H1830mm	1	SGRAY	602718881			208
AE184284	Firmgre® 4-Shelf Stationary Extension Kit - W460 x L1070 x H2140mm	1	SGRAY	602728881			208
AE184864	Firmgre® 4-Shelf Stationary Extension Kit - W460 x L1220 x H1630mm	1	SGRAY	602738881			208
AE184872	Firmgre® 4-Shelf Stationary Extension Kit - W460 x L1220 x H1830mm	1	SGRAY	602748881			208
AE184884	Firmgre® 4-Shelf Stationary Extension Kit - W460 x L1220 x H2140mm	1	SGRAY	602758881			208
AE185464	Firmgre® 4-Shelf Stationary Extension Kit - W460 x L1380 x H1630mm	1	SGRAY	602768881			208
AE185472	Firmgre® 4-Shelf Stationary Extension Kit - W460 x L1380 x H1830mm	1	SGRAY	602778881			208
AE185484	Firmgre® 4-Shelf Stationary Extension Kit - W460 x L1380 x H2140mm	1	SGRAY	602788881			208
AE186064	Firmgre® 4-Shelf Stationary Extension Kit - W460 x L1530 x H1630mm	1	SGRAY	602798881			208
AE186072	Firmgre® 4-Shelf Stationary Extension Kit - W460 x L1530 x H1830mm	1	SGRAY	602808881			208
AE186084	Firmgre® 4-Shelf Stationary Extension Kit - W460 x L1530 x H2140mm	1	SGRAY	602818881			208
AE187264	Firmgre® 4-Shelf Stationary Extension Kit - W460 x L1830 x H1630mm	1	SGRAY	602828881			208
AE187272	Firmgre® 4-Shelf Stationary Extension Kit - W460 x L1830 x H1830mm	1	SGRAY	602838881			208
AE187284	Firmgre® 4-Shelf Stationary Extension Kit - W460 x L1830 x H2140mm	1	SGRAY	602848881			208
AE187864	Firmgre® 4-Shelf Stationary Extension Kit - W460 x L1980 x H1630mm	1	SGRAY	602858881			208
AE187872	Firmgre® 4-Shelf Stationary Extension Kit - W460 x L1980 x H1830mm	1	SGRAY	602868881			208
AE187884	Firmgre® 4-Shelf Stationary Extension Kit - W460 x L1980 x H2140mm	1	SGRAY	602878881			208
AE212464	Firmgre® 4-Shelf Stationary Extension Kit - W540 x L610 x H1630mm	1	SGRAY	603158881			209
AE212472	Firmgre® 4-Shelf Stationary Extension Kit - W540 x L610 x H1830mm	1	SGRAY	603168881			209
AE212484	Firmgre® 4-Shelf Stationary Extension Kit - W540 x L610 x H2140mm	1	SGRAY	603178881			209
AE213064	Firmgre® 4-Shelf Stationary Extension Kit - W540 x L760 x H1630mm	1	SGRAY	603188881			209

# PRODUCT INDEX

No.	Product Name	Pack	Color	Order Code	Color	Order Code	Page
AE213072	Firmgre® 4-Shelf Stationary Extension Kit - W540 x L760 x H1830mm	1	SGRAY	603198881			209
AE213084	Firmgre® 4-Shelf Stationary Extension Kit - W540 x L760 x H2140mm	1	SGRAY	603208881			209
AE213664	Firmgre® 4-Shelf Stationary Extension Kit - W540 x L910 x H1630mm	1	SGRAY	603218881			209
AE213672	Firmgre® 4-Shelf Stationary Extension Kit - W540 x L910 x H1830mm	1	SGRAY	603228881			209
AE213684	Firmgre® 4-Shelf Stationary Extension Kit - W540 x L910 x H2140mm	1	SGRAY	603238881			209
AE214264	Firmgre® 4-Shelf Stationary Extension Kit - W540 x L1070 x H1630mm	1	SGRAY	603248881			209
AE214272	Firmgre® 4-Shelf Stationary Extension Kit - W540 x L1070 x H1830mm	1	SGRAY	603258881			209
AE214284	Firmgre® 4-Shelf Stationary Extension Kit - W540 x L1070 x H2140mm	1	SGRAY	603268881			209
AE214864	Firmgre® 4-Shelf Stationary Extension Kit - W540 x L1220 x H1630mm	1	SGRAY	603278881			209
AE214872	Firmgre® 4-Shelf Stationary Extension Kit - W540 x L1220 x H1830mm	1	SGRAY	603288881			209
AE214884	Firmgre® 4-Shelf Stationary Extension Kit - W540 x L1220 x H2140mm	1	SGRAY	603298881			209
AE215464	Firmgre® 4-Shelf Stationary Extension Kit - W540 x L1380 x H1630mm	1	SGRAY	603308881			209
AE215472	Firmgre® 4-Shelf Stationary Extension Kit - W540 x L1380 x H1830mm	1	SGRAY	603318881			209
AE215484	Firmgre® 4-Shelf Stationary Extension Kit - W540 x L1380 x H2140mm	1	SGRAY	603328881			209
AE216064	Firmgre® 4-Shelf Stationary Extension Kit - W540 x L1530 x H1630mm	1	SGRAY	603338881			209
AE216072	Firmgre® 4-Shelf Stationary Extension Kit - W540 x L1530 x H1830mm	1	SGRAY	603348881			209
AE216084	Firmgre® 4-Shelf Stationary Extension Kit - W540 x L1530 x H2140mm	1	SGRAY	603358881			209
AE217264	Firmgre® 4-Shelf Stationary Extension Kit - W540 x L1830 x H1630mm	1	SGRAY	603368881			209
AE217272	Firmgre® 4-Shelf Stationary Extension Kit - W540 x L1830 x H1830mm	1	SGRAY	603378881			209
AE217284	Firmgre® 4-Shelf Stationary Extension Kit - W540 x L1830 x H2140mm	1	SGRAY	603388881			209
AE217864	Firmgre® 4-Shelf Stationary Extension Kit - W540 x L1980 x H1630mm	1	SGRAY	603398881			209
AE217872	Firmgre® 4-Shelf Stationary Extension Kit - W540 x L1980 x H1830mm	1	SGRAY	603408881			209
AE217884	Firmgre® 4-Shelf Stationary Extension Kit - W540 x L1980 x H2140mm	1	SGRAY	603418881			209
AE242464	Firmgre® 4-Shelf Stationary Extension Kit - W610 x L610 x H1630mm	1	SGRAY	603698881			209
AE242472	Firmgre® 4-Shelf Stationary Extension Kit - W610 x L610 x H1830mm	1	SGRAY	603708881			209
AE242484	Firmgre® 4-Shelf Stationary Extension Kit - W610 x L610 x H2140mm	1	SGRAY	603718881			209
AE243064	Firmgre® 4-Shelf Stationary Extension Kit - W610 x L760 x H1630mm	1	SGRAY	603728881			209
AE243072	Firmgre® 4-Shelf Stationary Extension Kit - W610 x L760 x H1830mm	1	SGRAY	603738881			209
AE243084	Firmgre® 4-Shelf Stationary Extension Kit - W610 x L760 x H2140mm	1	SGRAY	603748881			209
AE243664	Firmgre® 4-Shelf Stationary Extension Kit - W610 x L910 x H1630mm	1	SGRAY	603758881			209
AE243672	Firmgre® 4-Shelf Stationary Extension Kit - W610 x L910 x H1830mm	1	SGRAY	603768881			209
AE243684	Firmgre® 4-Shelf Stationary Extension Kit - W610 x L910 x H2140mm	1	SGRAY	603778881			209
AE244264	Firmgre® 4-Shelf Stationary Extension Kit - W610 x L1070 x H1630mm	1	SGRAY	603788881			209
AE244272	Firmgre® 4-Shelf Stationary Extension Kit - W610 x L1070 x H1830mm	1	SGRAY	603798881			209
AE244284	Firmgre® 4-Shelf Stationary Extension Kit - W610 x L1070 x H2140mm	1	SGRAY	603808881			209
AE244864	Firmgre® 4-Shelf Stationary Extension Kit - W610 x L1220 x H1630mm	1	SGRAY	603818881			209
AE244872	Firmgre® 4-Shelf Stationary Extension Kit - W610 x L1220 x H1830mm	1	SGRAY	603828881			209

No.	Product Name	Pack	Color	Order Code	Color	Order Code	Page
AE244884	Firmgre® 4-Shelf Stationary Extension Kit - W610 x L1220 x H2140mm	1	SGRAY	603838881			209
AE245464	Firmgre® 4-Shelf Stationary Extension Kit - W610 x L1380 x H1630mm	1	SGRAY	603848881			209
AE245472	Firmgre® 4-Shelf Stationary Extension Kit - W610 x L1380 x H1830mm	1	SGRAY	603858881			209
AE245484	Firmgre® 4-Shelf Stationary Extension Kit - W610 x L1380 x H2140mm	1	SGRAY	603868881			209
AE246064	Firmgre® 4-Shelf Stationary Extension Kit - W610 x L1530 x H1630mm	1	SGRAY	603878881			209
AE246072	Firmgre® 4-Shelf Stationary Extension Kit - W610 x L1530 x H1830mm	1	SGRAY	603888881			209
AE246084	Firmgre® 4-Shelf Stationary Extension Kit - W610 x L1530 x H2140mm	1	SGRAY	603898881			209
AE247264	Firmgre® 4-Shelf Stationary Extension Kit - W610 x L1830 x H1630mm	1	SGRAY	603908881			209
AE247272	Firmgre® 4-Shelf Stationary Extension Kit - W610 x L1830 x H1830mm	1	SGRAY	603918881			209
AE247284	Firmgre® 4-Shelf Stationary Extension Kit - W610 x L1830 x H2140mm	1	SGRAY	603928881			209
AE247864	Firmgre® 4-Shelf Stationary Extension Kit - W610 x L1980 x H1630mm	1	SGRAY	603938881			209
AE247872	Firmgre® 4-Shelf Stationary Extension Kit - W610 x L1980 x H1830mm	1	SGRAY	603948881			209
AE247884	Firmgre® 4-Shelf Stationary Extension Kit - W610 x L1980 x H2140mm	1	SGRAY	603958881			209
AM143670	Firmgre® 4-Shelf Mobile Storage Kit - W360 x L910 x H1780mm	1	SGRAY	603968881			210
AM143678	Firmgre® 4-Shelf Mobile Storage Kit - W360 x L910 x H1980mm	1	SGRAY	603978881			210
AM144270	Firmgre® 4-Shelf Mobile Storage Kit - W360 x L1070 x H1780mm	1	SGRAY	603988881			210
AM144278	Firmgre® 4-Shelf Mobile Storage Kit - W360 x L1070 x H1980mm	1	SGRAY	603998881			210
AM144870	Firmgre® 4-Shelf Mobile Storage Kit - W360 x L1220 x H1780mm	1	SGRAY	604008881			210
AM144878	Firmgre® 4-Shelf Mobile Storage Kit - W360 x L1220 x H1980mm	1	SGRAY	604018881			210
AM145470	Firmgre® 4-Shelf Mobile Storage Kit - W360 x L1380 x H1780mm	1	SGRAY	604028881			210
AM145478	Firmgre® 4-Shelf Mobile Storage Kit - W360 x L1380 x H1980mm	1	SGRAY	604038881			210
AM146070	Firmgre® 4-Shelf Mobile Storage Kit - W360 x L1530 x H1780mm	1	SGRAY	604048881			210
AM146078	Firmgre® 4-Shelf Mobile Storage Kit - W360 x L1530 x H1980mm	1	SGRAY	604058881			210
AM183670	Firmgre® 4-Shelf Mobile Storage Kit - W460 x L910 x H1780mm	1	SGRAY	604068881			210
AM183678	Firmgre® 4-Shelf Mobile Storage Kit - W460 x L910 x H1980mm	1	SGRAY	604078881			210
AM184270	Firmgre® 4-Shelf Mobile Storage Kit - W460 x L1070 x H1780mm	1	SGRAY	604088881			210
AM184278	Firmgre® 4-Shelf Mobile Storage Kit - W460 x L1070 x H1980mm	1	SGRAY	604098881			210
AM184870	Firmgre® 4-Shelf Mobile Storage Kit - W460 x L1220 x H1780mm	1	SGRAY	604108881			210
AM184878	Firmgre® 4-Shelf Mobile Storage Kit - W460 x L1220 x H1980mm	1	SGRAY	604118881			210
AM185470	Firmgre® 4-Shelf Mobile Storage Kit - W460 x L1380 x H1780mm	1	SGRAY	604128881			210
AM185478	Firmgre® 4-Shelf Mobile Storage Kit - W460 x L1380 x H1980mm	1	SGRAY	604138881			210
AM186070	Firmgre® 4-Shelf Mobile Storage Kit - W460 x L1530 x H1780mm	1	SGRAY	604148881			210
AM186078	Firmgre® 4-Shelf Mobile Storage Kit - W460 x L1530 x H1980mm	1	SGRAY	604158881			210
AM213670	Firmgre® 4-Shelf Mobile Storage Kit - W540 x L910 x H1780mm	1	SGRAY	604168881			210
AM213678	Firmgre® 4-Shelf Mobile Storage Kit - W540 x L910 x H1980mm	1	SGRAY	604178881			210
AM214270	Firmgre® 4-Shelf Mobile Storage Kit - W540 x L1070 x H1780mm	1	SGRAY	604188881			210
AM214278	Firmgre® 4-Shelf Mobile Storage Kit - W540 x L1070 x H1980mm	1	SGRAY	604198881			210

# PRODUCT INDEX

No.	Product Name	Pack	Color	Order Code	Color	Order Code	Page
AM214870	Firmgre® 4-Shelf Mobile Storage Kit - W540 × L1220 × H1780mm	1	SGRAY	604208881			210
AM214878	Firmgre® 4-Shelf Mobile Storage Kit - W540 × L1220 × H1980mm	1	SGRAY	604218881			210
AM215470	Firmgre® 4-Shelf Mobile Storage Kit - W540 × L1380 × H1780mm	1	SGRAY	604228881			210
AM215478	Firmgre® 4-Shelf Mobile Storage Kit - W540 × L1380 × H1980mm	1	SGRAY	604238881			210
AM216070	Firmgre® 4-Shelf Mobile Storage Kit - W540 × L1530 × H1780mm	1	SGRAY	604248881			210
AM216078	Firmgre® 4-Shelf Mobile Storage Kit - W540 × L1530 × H1980mm	1	SGRAY	604258881			210
AM243670	Firmgre® 4-Shelf Mobile Storage Kit - W610 × L910 × H1780mm	1	SGRAY	604268881			210
AM243678	Firmgre® 4-Shelf Mobile Storage Kit - W610 × L910 × H1980mm	1	SGRAY	604278881			210
AM244270	Firmgre® 4-Shelf Mobile Storage Kit - W610 × L1070 × H1780mm	1	SGRAY	604288881			210
AM244278	Firmgre® 4-Shelf Mobile Storage Kit - W610 × L1070 × H1980mm	1	SGRAY	604298881			210
AM244870	Firmgre® 4-Shelf Mobile Storage Kit - W610 × L1220 × H1780mm	1	SGRAY	604308881			210
AM244878	Firmgre® 4-Shelf Mobile Storage Kit - W610 × L1220 × H1980mm	1	SGRAY	604318881			210
AM245470	Firmgre® 4-Shelf Mobile Storage Kit - W610 × L1380 × H1780mm	1	SGRAY	604328881			210
AM245478	Firmgre® 4-Shelf Mobile Storage Kit - W610 × L1380 × H1980mm	1	SGRAY	604338881			210
AM246070	Firmgre® 4-Shelf Mobile Storage Kit - W610 × L1530 × H1780mm	1	SGRAY	604348881			210
AM246078	Firmgre® 4-Shelf Mobile Storage Kit - W610 × L1530 × H1980mm	1	SGRAY	604358881			210
AX142464	Firmgre® 4-Shelf Stationary Starter Kit - W360 × L610 × H1630mm	1	SGRAY	604368881			208
AX142472	Firmgre® 4-Shelf Stationary Starter Kit - W360 × L610 × H1830mm	1	SGRAY	604378881			208
AX142484	Firmgre® 4-Shelf Stationary Starter Kit - W360 × L610 × H2140mm	1	SGRAY	601828881			208
AX143064	Firmgre® 4-Shelf Stationary Starter Kit - W360 × L760 × H1630mm	1	SGRAY	601838881			208
AX143072	Firmgre® 4-Shelf Stationary Starter Kit - W360 × L760 × H1830mm	1	SGRAY	601848881			208
AX143084	Firmgre® 4-Shelf Stationary Starter Kit - W360 × L760 × H2140mm	1	SGRAY	601858881			208
AX143664	Firmgre® 4-Shelf Stationary Starter Kit - W360 × L910 × H1630mm	1	SGRAY	601868881			208
AX143672	Firmgre® 4-Shelf Stationary Starter Kit - W360 × L910 × H1830mm	1	SGRAY	601878881			208
AX143684	Firmgre® 4-Shelf Stationary Starter Kit - W360 × L910 × H2140mm	1	SGRAY	601888881			208
AX144264	Firmgre® 4-Shelf Stationary Starter Kit - W360 × L1070 × H1630mm	1	SGRAY	601898881			208
AX144272	Firmgre® 4-Shelf Stationary Starter Kit - W360 × L1070 × H1830mm	1	SGRAY	601908881			208
AX144284	Firmgre® 4-Shelf Stationary Starter Kit - W360 × L1070 × H2140mm	1	SGRAY	601918881			208
AX144864	Firmgre® 4-Shelf Stationary Starter Kit - W360 × L1220 × H1630mm	1	SGRAY	601928881			208
AX144872	Firmgre® 4-Shelf Stationary Starter Kit - W360 × L1220 × H1830mm	1	SGRAY	601938881			208
AX144884	Firmgre® 4-Shelf Stationary Starter Kit - W360 × L1220 × H2140mm	1	SGRAY	601948881			208
AX145464	Firmgre® 4-Shelf Stationary Starter Kit - W360 × L1380 × H1630mm	1	SGRAY	601958881			208
AX145472	Firmgre® 4-Shelf Stationary Starter Kit - W360 × L1380 × H1830mm	1	SGRAY	601968881			208
AX145484	Firmgre® 4-Shelf Stationary Starter Kit - W360 × L1380 × H2140mm	1	SGRAY	601978881			208
AX146064	Firmgre® 4-Shelf Stationary Starter Kit - W360 × L1530 × H1630mm	1	SGRAY	601988881			208
AX146072	Firmgre® 4-Shelf Stationary Starter Kit - W360 × L1530 × H1830mm	1	SGRAY	601998881			208
AX146084	Firmgre® 4-Shelf Stationary Starter Kit - W360 × L1530 × H2140mm	1	SGRAY	602008881			208

No.	Product Name	Pack	Color	Order Code	Color	Order Code	Page
AX147264	Firmgre® 4-Shelf Stationary Starter Kit - W360 x L1830 x H1630mm	1	SGRAY	602018881			208
AX147272	Firmgre® 4-Shelf Stationary Starter Kit - W360 x L1830 x H1830mm	1	SGRAY	602028881			208
AX147284	Firmgre® 4-Shelf Stationary Starter Kit - W360 x L1830 x H2140mm	1	SGRAY	602038881			208
AX147864	Firmgre® 4-Shelf Stationary Starter Kit - W360 x L1980 x H1630mm	1	SGRAY	602048881			208
AX147872	Firmgre® 4-Shelf Stationary Starter Kit - W360 x L1980 x H1830mm	1	SGRAY	602058881			208
AX147884	Firmgre® 4-Shelf Stationary Starter Kit - W360 x L1980 x H2140mm	1	SGRAY	602068881			208
AX182464	Firmgre® 4-Shelf Stationary Starter Kit - W460 x L610 x H1630mm	1	SGRAY	602348881			208
AX182472	Firmgre® 4-Shelf Stationary Starter Kit - W460 x L610 x H1830mm	1	SGRAY	602358881			208
AX182484	Firmgre® 4-Shelf Stationary Starter Kit - W460 x L610 x H2140mm	1	SGRAY	602368881			208
AX183064	Firmgre® 4-Shelf Stationary Starter Kit - W460 x L760 x H1630mm	1	SGRAY	602378881			208
AX183072	Firmgre® 4-Shelf Stationary Starter Kit - W460 x L760 x H1830mm	1	SGRAY	602388881			208
AX183084	Firmgre® 4-Shelf Stationary Starter Kit - W460 x L760 x H2140mm	1	SGRAY	602398881			208
AX183664	Firmgre® 4-Shelf Stationary Starter Kit - W460 x L910 x H1630mm	1	SGRAY	602408881			208
AX183672	Firmgre® 4-Shelf Stationary Starter Kit - W460 x L910 x H1830mm	1	SGRAY	602418881			208
AX183684	Firmgre® 4-Shelf Stationary Starter Kit - W460 x L910 x H2140mm	1	SGRAY	602428881			208
AX184264	Firmgre® 4-Shelf Stationary Starter Kit - W460 x L1070 x H1630mm	1	SGRAY	602438881			208
AX184272	Firmgre® 4-Shelf Stationary Starter Kit - W460 x L1070 x H1830mm	1	SGRAY	602448881			208
AX184284	Firmgre® 4-Shelf Stationary Starter Kit - W460 x L1070 x H2140mm	1	SGRAY	602458881			208
AX184864	Firmgre® 4-Shelf Stationary Starter Kit - W460 x L1220 x H1630mm	1	SGRAY	602468881			208
AX184872	Firmgre® 4-Shelf Stationary Starter Kit - W460 x L1220 x H1830mm	1	SGRAY	602478881			208
AX184884	Firmgre® 4-Shelf Stationary Starter Kit - W460 x L1220 x H2140mm	1	SGRAY	602488881			208
AX185464	Firmgre® 4-Shelf Stationary Starter Kit - W460 x L1380 x H1630mm	1	SGRAY	602498881			208
AX185472	Firmgre® 4-Shelf Stationary Starter Kit - W460 x L1380 x H1830mm	1	SGRAY	602508881			208
AX185484	Firmgre® 4-Shelf Stationary Starter Kit - W460 x L1380 x H2140mm	1	SGRAY	602518881			208
AX186064	Firmgre® 4-Shelf Stationary Starter Kit - W460 x L1530 x H1630mm	1	SGRAY	602528881			208
AX186072	Firmgre® 4-Shelf Stationary Starter Kit - W460 x L1530 x H1830mm	1	SGRAY	602538881			208
AX186084	Firmgre® 4-Shelf Stationary Starter Kit - W460 x L1530 x H2140mm	1	SGRAY	602548881			208
AX187264	Firmgre® 4-Shelf Stationary Starter Kit - W460 x L1830 x H1630mm	1	SGRAY	602558881			208
AX187272	Firmgre® 4-Shelf Stationary Starter Kit - W460 x L1830 x H1830mm	1	SGRAY	602568881			208
AX187284	Firmgre® 4-Shelf Stationary Starter Kit - W460 x L1830 x H2140mm	1	SGRAY	602578881			208
AX187864	Firmgre® 4-Shelf Stationary Starter Kit - W460 x L1980 x H1630mm	1	SGRAY	602588881			208
AX187872	Firmgre® 4-Shelf Stationary Starter Kit - W460 x L1980 x H1830mm	1	SGRAY	602598881			208
AX187884	Firmgre® 4-Shelf Stationary Starter Kit - W460 x L1980 x H2140mm	1	SGRAY	602608881			208
AX212464	Firmgre® 4-Shelf Stationary Starter Kit - W540 x L610 x H1630mm	1	SGRAY	602888881			209
AX212472	Firmgre® 4-Shelf Stationary Starter Kit - W540 x L610 x H1830mm	1	SGRAY	602898881			209
AX212484	Firmgre® 4-Shelf Stationary Starter Kit - W540 x L610 x H2140mm	1	SGRAY	602908881			209
AX213064	Firmgre® 4-Shelf Stationary Starter Kit - W540 x L760 x H1630mm	1	SGRAY	602918881			209

# PRODUCT INDEX

No.	Product Name	Pack	Color	Order Code	Color	Order Code	Page
AX213072	Firmgre® 4-Shelf Stationary Starter Kit - W540 × L760 × H1830mm	1	SGRAY	602928881			209
AX213084	Firmgre® 4-Shelf Stationary Starter Kit - W540 × L760 × H2140mm	1	SGRAY	602938881			209
AX213664	Firmgre® 4-Shelf Stationary Starter Kit - W540 × L910 × H1630mm	1	SGRAY	602948881			209
AX213672	Firmgre® 4-Shelf Stationary Starter Kit - W540 × L910 × H1830mm	1	SGRAY	602958881			209
AX213684	Firmgre® 4-Shelf Stationary Starter Kit - W540 × L910 × H2140mm	1	SGRAY	602968881			209
AX214264	Firmgre® 4-Shelf Stationary Starter Kit - W540 × L1070 × H1630mm	1	SGRAY	602978881			209
AX214272	Firmgre® 4-Shelf Stationary Starter Kit - W540 × L1070 × H1830mm	1	SGRAY	602988881			209
AX214284	Firmgre® 4-Shelf Stationary Starter Kit - W540 × L1070 × H2140mm	1	SGRAY	602998881			209
AX214864	Firmgre® 4-Shelf Stationary Starter Kit - W540 × L1220 × H1630mm	1	SGRAY	603008881			209
AX214872	Firmgre® 4-Shelf Stationary Starter Kit - W540 × L1220 × H1830mm	1	SGRAY	603018881			209
AX214884	Firmgre® 4-Shelf Stationary Starter Kit - W540 × L1220 × H2140mm	1	SGRAY	603028881			209
AX215464	Firmgre® 4-Shelf Stationary Starter Kit - W540 × L1380 × H1630mm	1	SGRAY	603038881			209
AX215472	Firmgre® 4-Shelf Stationary Starter Kit - W540 × L1380 × H1830mm	1	SGRAY	603048881			209
AX215484	Firmgre® 4-Shelf Stationary Starter Kit - W540 × L1380 × H2140mm	1	SGRAY	603058881			209
AX216064	Firmgre® 4-Shelf Stationary Starter Kit - W540 × L1530 × H1630mm	1	SGRAY	603068881			209
AX216072	Firmgre® 4-Shelf Stationary Starter Kit - W540 × L1530 × H1830mm	1	SGRAY	603078881			209
AX216084	Firmgre® 4-Shelf Stationary Starter Kit - W540 × L1530 × H2140mm	1	SGRAY	603088881			209
AX217264	Firmgre® 4-Shelf Stationary Starter Kit - W540 × L1830 × H1630mm	1	SGRAY	603098881			209
AX217272	Firmgre® 4-Shelf Stationary Starter Kit - W540 × L1830 × H1830mm	1	SGRAY	603108881			209
AX217284	Firmgre® 4-Shelf Stationary Starter Kit - W540 × L1830 × H2140mm	1	SGRAY	603118881			209
AX217864	Firmgre® 4-Shelf Stationary Starter Kit - W540 × L1980 × H1630mm	1	SGRAY	603128881			209
AX217872	Firmgre® 4-Shelf Stationary Starter Kit - W540 × L1980 × H1830mm	1	SGRAY	603138881			209
AX217884	Firmgre® 4-Shelf Stationary Starter Kit - W540 × L1980 × H2140mm	1	SGRAY	603148881			209
AX242464	Firmgre® 4-Shelf Stationary Starter Kit - W610 × L610 × H1630mm	1	SGRAY	603428881			209
AX242472	Firmgre® 4-Shelf Stationary Starter Kit - W610 × L610 × H1830mm	1	SGRAY	603438881			209
AX242484	Firmgre® 4-Shelf Stationary Starter Kit - W610 × L610 × H2140mm	1	SGRAY	603448881			209
AX243064	Firmgre® 4-Shelf Stationary Starter Kit - W610 × L760 × H1630mm	1	SGRAY	603458881			209
AX243072	Firmgre® 4-Shelf Stationary Starter Kit - W610 × L760 × H1830mm	1	SGRAY	603468881			209
AX243084	Firmgre® 4-Shelf Stationary Starter Kit - W610 × L760 × H2140mm	1	SGRAY	603478881			209
AX243664	Firmgre® 4-Shelf Stationary Starter Kit - W610 × L910 × H1630mm	1	SGRAY	603488881			209
AX243672	Firmgre® 4-Shelf Stationary Starter Kit - W610 × L910 × H1830mm	1	SGRAY	603498881			209
AX243684	Firmgre® 4-Shelf Stationary Starter Kit - W610 × L910 × H2140mm	1	SGRAY	603508881			209
AX244264	Firmgre® 4-Shelf Stationary Starter Kit - W610 × L1070 × H1630mm	1	SGRAY	603518881			209
AX244272	Firmgre® 4-Shelf Stationary Starter Kit - W610 × L1070 × H1830mm	1	SGRAY	603528881			209
AX244284	Firmgre® 4-Shelf Stationary Starter Kit - W610 × L1070 × H2140mm	1	SGRAY	603538881			209
AX244864	Firmgre® 4-Shelf Stationary Starter Kit - W610 × L1220 × H1630mm	1	SGRAY	603548881			209
AX244872	Firmgre® 4-Shelf Stationary Starter Kit - W610 × L1220 × H1830mm	1	SGRAY	603558881			209

No.	Product Name	Pack	Color	Order Code	Color	Order Code	Page
AX244884	Firmgre® 4-Shelf Stationary Starter Kit - W610 x L1220 x H2140mm	1	SGRAY	603568881			209
AX245464	Firmgre® 4-Shelf Stationary Starter Kit - W610 x L1380 x H1630mm	1	SGRAY	603578881			209
AX245472	Firmgre® 4-Shelf Stationary Starter Kit - W610 x L1380 x H1830mm	1	SGRAY	603588881			209
AX245484	Firmgre® 4-Shelf Stationary Starter Kit - W610 x L1380 x H2140mm	1	SGRAY	603598881			209
AX246064	Firmgre® 4-Shelf Stationary Starter Kit - W610 x L1530 x H1630mm	1	SGRAY	603608881			209
AX246072	Firmgre® 4-Shelf Stationary Starter Kit - W610 x L1530 x H1830mm	1	SGRAY	603618881			209
AX246084	Firmgre® 4-Shelf Stationary Starter Kit - W610 x L1530 x H2140mm	1	SGRAY	603628881			209
AX247264	Firmgre® 4-Shelf Stationary Starter Kit - W610 x L1830 x H1630mm	1	SGRAY	603638881			209
AX247272	Firmgre® 4-Shelf Stationary Starter Kit - W610 x L1830 x H1830mm	1	SGRAY	603648881			209
AX247284	Firmgre® 4-Shelf Stationary Starter Kit - W610 x L1830 x H2140mm	1	SGRAY	603658881			209
AX247864	Firmgre® 4-Shelf Stationary Starter Kit - W610 x L1980 x H1630mm	1	SGRAY	603668881			209
AX247872	Firmgre® 4-Shelf Stationary Starter Kit - W610 x L1980 x H1830mm	1	SGRAY	603678881			209
AX247884	Firmgre® 4-Shelf Stationary Starter Kit - W610 x L1980 x H2140mm	1	SGRAY	603688881			209
BC1210	Top		BLA	2A029137010			178
BC4845	Top		BLA	2A008137010			178
BCHA1210-09	Heavy-load Bulk Container		BLA	8A0308881			178
BCHA1210-10	Heavy-load Bulk Container		BLA	8A0308882			178
BCHA1210-11	Heavy-load Bulk Container		BLA	8A0308883			178
BCHA4845-25	Heavy-load Bulk Container		BLA	8A0088886			178
BCHA4845-34	Heavy-load Bulk Container		BLA	8A0088883			178
BCHA4845-39	Heavy-load Bulk Container		BLA	8A0088882			178
BCHA4845-42	Heavy-load Bulk Container		BLA	8A0088885			178
BCHA4845-46	Heavy-load Bulk Container		BLA	8A0088884			178
BE183064	Firmgre® Modus 4-Shelf Stationary Extension Kit - W460 x L760 x H1630mm	1	SGRAY	604848881			214
BE183072	Firmgre® Modus 4-Shelf Stationary Extension Kit - W460 x L760 x H1830mm	1	SGRAY	604858881			214
BE183084	Firmgre® Modus 4-Shelf Stationary Extension Kit - W460 x L760 x H2140mm	1	SGRAY	604868881			214
BE183664	Firmgre® Modus 4-Shelf Stationary Extension Kit - W460 x L910 x H1630mm	1	SGRAY	604878881			214
BE183672	Firmgre® Modus 4-Shelf Stationary Extension Kit - W460 x L910 x H1830mm	1	SGRAY	604888881			214
BE183684	Firmgre® Modus 4-Shelf Stationary Extension Kit - W460 x L910 x H2140mm	1	SGRAY	604898881			214
BE184264	Firmgre® Modus 4-Shelf Stationary Extension Kit - W460 x L1070 x H1630mm	1	SGRAY	604908881			214
BE184272	Firmgre® Modus 4-Shelf Stationary Extension Kit - W460 x L1070 x H1830mm	1	SGRAY	604918881			214
BE184284	Firmgre® Modus 4-Shelf Stationary Extension Kit - W460 x L1070 x H2140mm	1	SGRAY	604928881			214
BE184864	Firmgre® Modus 4-Shelf Stationary Extension Kit - W460 x L1220 x H1630mm	1	SGRAY	604938881			214
BE184872	Firmgre® Modus 4-Shelf Stationary Extension Kit - W460 x L1220 x H1830mm	1	SGRAY	604948881			214
BE184884	Firmgre® Modus 4-Shelf Stationary Extension Kit - W460 x L1220 x H2140mm	1	SGRAY	604958881			214
BE185464	Firmgre® Modus 4-Shelf Stationary Extension Kit - W460 x L1380 x H1630mm	1	SGRAY	604968881			214
BE185472	Firmgre® Modus 4-Shelf Stationary Extension Kit - W460 x L1380 x H1830mm	1	SGRAY	604978881			214
BE185484	Firmgre® Modus 4-Shelf Stationary Extension Kit - W460 x L1380 x H2140mm	1	SGRAY	604988881			214
BE186064	Firmgre® Modus 4-Shelf Stationary Extension Kit - W460 x L1530 x H1630mm	1	SGRAY	604998881			214
BE186072	Firmgre® Modus 4-Shelf Stationary Extension Kit - W460 x L1530 x H1830mm	1	SGRAY	605008881			214
BE186084	Firmgre® Modus 4-Shelf Stationary Extension Kit - W460 x L1530 x H2140mm	1	SGRAY	605018881			214

# PRODUCT INDEX

No.	Product Name	Pack	Color	Order Code	Color	Order Code	Page
BE213064	Firmgre® Modus 4-Shelf Stationary Extension Kit - W540 x L760 x H1630mm	1	SGRAY	605028881			215
BE213072	Firmgre® Modus 4-Shelf Stationary Extension Kit - W540 x L760 x H1830mm	1	SGRAY	605038881			215
BE213084	Firmgre® Modus 4-Shelf Stationary Extension Kit - W540 x L760 x H2140mm	1	SGRAY	605048881			215
BE213664	Firmgre® Modus 4-Shelf Stationary Extension Kit - W540 x L910 x H1630mm	1	SGRAY	605058881			215
BE213672	Firmgre® Modus 4-Shelf Stationary Extension Kit - W540 x L910 x H1830mm	1	SGRAY	605068881			215
BE213684	Firmgre® Modus 4-Shelf Stationary Extension Kit - W540 x L910 x H2140mm	1	SGRAY	605078881			215
BE214264	Firmgre® Modus 4-Shelf Stationary Extension Kit - W540 x L1070 x H1630mm	1	SGRAY	605088881			215
BE214272	Firmgre® Modus 4-Shelf Stationary Extension Kit - W540 x L1070 x H1830mm	1	SGRAY	605098881			215
BE214284	Firmgre® Modus 4-Shelf Stationary Extension Kit - W540 x L1070 x H2140mm	1	SGRAY	605108881			215
BE214864	Firmgre® Modus 4-Shelf Stationary Extension Kit - W540 x L1220 x H1630mm	1	SGRAY	605118881			215
BE214872	Firmgre® Modus 4-Shelf Stationary Extension Kit - W540 x L1220 x H1830mm	1	SGRAY	605128881			215
BE214884	Firmgre® Modus 4-Shelf Stationary Extension Kit - W540 x L1220 x H2140mm	1	SGRAY	605138881			215
BE215464	Firmgre® Modus 4-Shelf Stationary Extension Kit - W540 x L1380 x H1630mm	1	SGRAY	605148881			215
BE215472	Firmgre® Modus 4-Shelf Stationary Extension Kit - W540 x L1380 x H1830mm	1	SGRAY	605158881			215
BE215484	Firmgre® Modus 4-Shelf Stationary Extension Kit - W540 x L1380 x H2140mm	1	SGRAY	605168881			215
BE216064	Firmgre® Modus 4-Shelf Stationary Extension Kit - W540 x L1530 x H1630mm	1	SGRAY	605178881			215
BE216072	Firmgre® Modus 4-Shelf Stationary Extension Kit - W540 x L1530 x H1830mm	1	SGRAY	605188881			215
BE216084	Firmgre® Modus 4-Shelf Stationary Extension Kit - W540 x L1530 x H2140mm	1	SGRAY	605198881			215
BE243064	Firmgre® Modus 4-Shelf Stationary Extension Kit - W610 x L760 x H1630mm	1	SGRAY	605208881			215
BE243072	Firmgre® Modus 4-Shelf Stationary Extension Kit - W610 x L760 x H1830mm	1	SGRAY	605218881			215
BE243084	Firmgre® Modus 4-Shelf Stationary Extension Kit - W610 x L760 x H2140mm	1	SGRAY	605228881			215
BE243664	Firmgre® Modus 4-Shelf Stationary Extension Kit - W610 x L910 x H1630mm	1	SGRAY	605238881			215
BE243672	Firmgre® Modus 4-Shelf Stationary Extension Kit - W610 x L910 x H1830mm	1	SGRAY	605248881			215
BE243684	Firmgre® Modus 4-Shelf Stationary Extension Kit - W610 x L910 x H2140mm	1	SGRAY	605258881			215
BE244264	Firmgre® Modus 4-Shelf Stationary Extension Kit - W610 x L1070 x H1630mm	1	SGRAY	605268881			215
BE244272	Firmgre® Modus 4-Shelf Stationary Extension Kit - W610 x L1070 x H1830mm	1	SGRAY	605278881			215
BE244284	Firmgre® Modus 4-Shelf Stationary Extension Kit - W610 x L1070 x H2140mm	1	SGRAY	605288881			215
BE244864	Firmgre® Modus 4-Shelf Stationary Extension Kit - W610 x L1220 x H1630mm	1	SGRAY	605298881			215
BE244872	Firmgre® Modus 4-Shelf Stationary Extension Kit - W610 x L1220 x H1830mm	1	SGRAY	605308881			215
BE244884	Firmgre® Modus 4-Shelf Stationary Extension Kit - W610 x L1220 x H2140mm	1	SGRAY	605318881			215
BE245464	Firmgre® Modus 4-Shelf Stationary Extension Kit - W610 x L1380 x H1630mm	1	SGRAY	605328881			215
BE245472	Firmgre® Modus 4-Shelf Stationary Extension Kit - W610 x L1380 x H1830mm	1	SGRAY	605338881			215
BE245484	Firmgre® Modus 4-Shelf Stationary Extension Kit - W610 x L1380 x H2140mm	1	SGRAY	605348881			215
BE246064	Firmgre® Modus 4-Shelf Stationary Extension Kit - W610 x L1530 x H1630mm	1	SGRAY	605358881			215
BE246072	Firmgre® Modus 4-Shelf Stationary Extension Kit - W610 x L1530 x H1830mm	1	SGRAY	605368881			215
BE246084	Firmgre® Modus 4-Shelf Stationary Extension Kit - W610 x L1530 x H2140mm	1	SGRAY	605378881			215
BX183064	Firmgre® Modus 4-Shelf Stationary Starter Kit - W460 x L760 x H1630mm	1	SGRAY	605388881			214

No.	Product Name	Pack	Color	Order Code	Color	Order Code	Page
BX183072	Firmgre® Modus 4-Shelf Stationary Starter Kit - W460 x L760 x H1830mm	1	SGRAY	605398881			214
BX183084	Firmgre® Modus 4-Shelf Stationary Starter Kit - W460 x L760 x H2140mm	1	SGRAY	605408881			214
BX183664	Firmgre® Modus 4-Shelf Stationary Starter Kit - W460 x L910 x H1630mm	1	SGRAY	605418881			214
BX183672	Firmgre® Modus 4-Shelf Stationary Starter Kit - W460 x L910 x H1830mm	1	SGRAY	605428881			214
BX183684	Firmgre® Modus 4-Shelf Stationary Starter Kit - W460 x L910 x H2140mm	1	SGRAY	605438881			214
BX184264	Firmgre® Modus 4-Shelf Stationary Starter Kit - W460 x L1070 x H1630mm	1	SGRAY	605448881			214
BX184272	Firmgre® Modus 4-Shelf Stationary Starter Kit - W460 x L1070 x H1830mm	1	SGRAY	605458881			214
BX184284	Firmgre® Modus 4-Shelf Stationary Starter Kit - W460 x L1070 x H2140mm	1	SGRAY	605468881			214
BX184864	Firmgre® Modus 4-Shelf Stationary Starter Kit - W460 x L1220 x H1630mm	1	SGRAY	605478881			214
BX184872	Firmgre® Modus 4-Shelf Stationary Starter Kit - W460 x L1220 x H1830mm	1	SGRAY	605488881			214
BX184884	Firmgre® Modus 4-Shelf Stationary Starter Kit - W460 x L1220 x H2140mm	1	SGRAY	605498881			214
BX185464	Firmgre® Modus 4-Shelf Stationary Starter Kit - W460 x L1380 x H1630mm	1	SGRAY	605508881			214
BX185472	Firmgre® Modus 4-Shelf Stationary Starter Kit - W460 x L1380 x H1830mm	1	SGRAY	605518881			214
BX185484	Firmgre® Modus 4-Shelf Stationary Starter Kit - W460 x L1380 x H2140mm	1	SGRAY	605528881			214
BX186064	Firmgre® Modus 4-Shelf Stationary Starter Kit - W460 x L1530 x H1630mm	1	SGRAY	605538881			214
BX186072	Firmgre® Modus 4-Shelf Stationary Starter Kit - W460 x L1530 x H1830mm	1	SGRAY	605548881			214
BX186084	Firmgre® Modus 4-Shelf Stationary Starter Kit - W460 x L1530 x H2140mm	1	SGRAY	605558881			214
BX213064	Firmgre® Modus 4-Shelf Stationary Starter Kit - W540 x L760 x H1630mm	1	SGRAY	605568881			215
BX213072	Firmgre® Modus 4-Shelf Stationary Starter Kit - W540 x L760 x H1830mm	1	SGRAY	605578881			215
BX213084	Firmgre® Modus 4-Shelf Stationary Starter Kit - W540 x L760 x H2140mm	1	SGRAY	605588881			215
BX213664	Firmgre® Modus 4-Shelf Stationary Starter Kit - W540 x L910 x H1630mm	1	SGRAY	605598881			215
BX213672	Firmgre® Modus 4-Shelf Stationary Starter Kit - W540 x L910 x H1830mm	1	SGRAY	605608881			215
BX213684	Firmgre® Modus 4-Shelf Stationary Starter Kit - W540 x L910 x H2140mm	1	SGRAY	605618881			215
BX214264	Firmgre® Modus 4-Shelf Stationary Starter Kit - W540 x L1070 x H1630mm	1	SGRAY	605628881			215
BX214272	Firmgre® Modus 4-Shelf Stationary Starter Kit - W540 x L1070 x H1830mm	1	SGRAY	605638881			215
BX214284	Firmgre® Modus 4-Shelf Stationary Starter Kit - W540 x L1070 x H2140mm	1	SGRAY	605648881			215
BX214864	Firmgre® Modus 4-Shelf Stationary Starter Kit - W540 x L1220 x H1630mm	1	SGRAY	605658881			215
BX214872	Firmgre® Modus 4-Shelf Stationary Starter Kit - W540 x L1220 x H1830mm	1	SGRAY	605668881			215
BX214884	Firmgre® Modus 4-Shelf Stationary Starter Kit - W540 x L1220 x H2140mm	1	SGRAY	605678881			215
BX215464	Firmgre® Modus 4-Shelf Stationary Starter Kit - W540 x L1380 x H1630mm	1	SGRAY	605688881			215
BX215472	Firmgre® Modus 4-Shelf Stationary Starter Kit - W540 x L1380 x H1830mm	1	SGRAY	605698881			215
BX215484	Firmgre® Modus 4-Shelf Stationary Starter Kit - W540 x L1380 x H2140mm	1	SGRAY	605708881			215
BX216064	Firmgre® Modus 4-Shelf Stationary Starter Kit - W540 x L1530 x H1630mm	1	SGRAY	605718881			215
BX216072	Firmgre® Modus 4-Shelf Stationary Starter Kit - W540 x L1530 x H1830mm	1	SGRAY	605728881			215
BX216084	Firmgre® Modus 4-Shelf Stationary Starter Kit - W540 x L1530 x H2140mm	1	SGRAY	605738881			215
BX243064	Firmgre® Modus 4-Shelf Stationary Starter Kit - W610 x L760 x H1630mm	1	SGRAY	605748881			215
BX243072	Firmgre® Modus 4-Shelf Stationary Starter Kit - W610 x L760 x H1830mm	1	SGRAY	605758881			215

# PRODUCT INDEX

No.	Product Name	Pack	Color	Order Code	Color	Order Code	Page
BX243084	Firmgre® Modus 4-Shelf Stationary Starter Kit - W610 x L760 x H2140mm	1	SGRAY	605768881			215
BX243664	Firmgre® Modus 4-Shelf Stationary Starter Kit - W610 x L910 x H1630mm	1	SGRAY	605778881			215
BX243672	Firmgre® Modus 4-Shelf Stationary Starter Kit - W610 x L910 x H1830mm	1	SGRAY	605788881			215
BX243684	Firmgre® Modus 4-Shelf Stationary Starter Kit - W610 x L910 x H2140mm	1	SGRAY	605798881			215
BX244264	Firmgre® Modus 4-Shelf Stationary Starter Kit - W610 x L1070 x H1630mm	1	SGRAY	605808881			215
BX244272	Firmgre® Modus 4-Shelf Stationary Starter Kit - W610 x L1070 x H1830mm	1	SGRAY	605818881			215
BX244284	Firmgre® Modus 4-Shelf Stationary Starter Kit - W610 x L1070 x H2140mm	1	SGRAY	605828881			215
BX244864	Firmgre® Modus 4-Shelf Stationary Starter Kit - W610 x L1220 x H1630mm	1	SGRAY	605838881			215
BX244872	Firmgre® Modus 4-Shelf Stationary Starter Kit - W610 x L1220 x H1830mm	1	SGRAY	605848881			215
BX244884	Firmgre® Modus 4-Shelf Stationary Starter Kit - W610 x L1220 x H2140mm	1	SGRAY	605858881			215
BX245464	Firmgre® Modus 4-Shelf Stationary Starter Kit - W610 x L1380 x H1630mm	1	SGRAY	605868881			215
BX245472	Firmgre® Modus 4-Shelf Stationary Starter Kit - W610 x L1380 x H1830mm	1	SGRAY	605878881			215
BX245484	Firmgre® Modus 4-Shelf Stationary Starter Kit - W610 x L1380 x H2140mm	1	SGRAY	605888881			215
BX246064	Firmgre® Modus 4-Shelf Stationary Starter Kit - W610 x L1530 x H1630mm	1	SGRAY	605898881			215
BX246072	Firmgre® Modus 4-Shelf Stationary Starter Kit - W610 x L1530 x H1830mm	1	SGRAY	605908881			215
BX246084	Firmgre® Modus 4-Shelf Stationary Starter Kit - W610 x L1530 x H2140mm	1	SGRAY	605918881			215
PNB1111	Nestable Pallet		BLA	8A0208881			176
PNB1208	Nestable Pallet		BLA	8A0238881			176
PNB1210	Nestable Pallet		BLA	8A0028881			176
PRB1210	Shelf Pallet		BLA	8A0068881			177
PSB1210	Stacking Pallet		BLA	8A0158889			177
XA1800	Firmgre® Modus Dunnage Stand - W460 x H170mm	1	GRAY	604468881			217
XA1801	Firmgre® Modus Dunnage Stand - W460 x H270mm	1	GRAY	604478881			217
XA1864	Firmgre® Modus Stationary Post Kit - W460 x H1630mm	1	GRAY	604528881			217
XA1872	Firmgre® Modus Stationary Post Kit - W460 x H1830mm	1	GRAY	604538881			217
XA1884	Firmgre® Modus Stationary Post Kit - W460 x H2140mm	1	GRAY	604548881			217
XA2100	Firmgre® Modus Dunnage Stand - W540 x H170mm	1	GRAY	604488881			217
XA2101	Firmgre® Modus Dunnage Stand - W540 x H270mm	1	GRAY	604498881			217
XA2164	Firmgre® Modus Stationary Post Kit - W540 x H1630mm	1	GRAY	604558881			217
XA2172	Firmgre® Modus Stationary Post Kit - W540 x H1830mm	1	GRAY	604568881			217
XA2184	Firmgre® Modus Stationary Post Kit - W540 x H2140mm	1	GRAY	604578881			217
XA2400	Firmgre® Modus Dunnage Stand - W610 x H170mm	1	GRAY	604508881			217
XA2401	Firmgre® Modus Dunnage Stand - W610 x H270mm	1	GRAY	604518881			217
XA2464	Firmgre® Modus Stationary Post Kit - W610 x H1630mm	1	GRAY	604588881			217
XA2472	Firmgre® Modus Stationary Post Kit - W610 x H1830mm	1	GRAY	604598881			217
XA2484	Firmgre® Modus Stationary Post Kit - W610 x H2140mm	1	GRAY	604608881			217
XB0001	Firmgre® Modus Corner Connector	1	GRAY	604618881			216
XB0002	Firmgre® Modus Identification Tag 15cm	12	GRAY	604628881			216
XB0003	Firmgre® Modus Identification Tag 7.6cm	12	GRAY	604638881			216
XB0004	Firmgre® Modus Wall Fastener	4	SS	604648881			216
XB0005	Firmgre® Modus Seismic Foot	4	SS	604658881			216
XB1830	Firmgre® Modus Shelf Kit - W460 x L760mm	1	SGRAY	604668881			217
XB1836	Firmgre® Modus Shelf Kit - W460 x L910mm	1	SGRAY	604678881			217
XB1842	Firmgre® Modus Shelf Kit - W460 x L1070mm	1	SGRAY	604688881			217
XB1848	Firmgre® Modus Shelf Kit - W460 x L1220mm	1	SGRAY	604698881			217
XB1854	Firmgre® Modus Shelf Kit - W460 x L1380mm	1	SGRAY	604708881			217
XB1860	Firmgre® Modus Shelf Kit - W460 x L1530mm	1	SGRAY	604718881			217
XB2130	Firmgre® Modus Shelf Kit - W540 x L760mm	1	SGRAY	604728881			217
XB2136	Firmgre® Modus Shelf Kit - W540 x L910mm	1	SGRAY	604738881			217
XB2142	Firmgre® Modus Shelf Kit - W540 x L1070mm	1	SGRAY	604748881			217
XB2148	Firmgre® Modus Shelf Kit - W540 x L1220mm	1	SGRAY	604758881			217
XB2154	Firmgre® Modus Shelf Kit - W540 x L1380mm	1	SGRAY	604768881			217

No.	Product Name	Pack	Color	Order Code	Color	Order Code	Page
XB2160	Firmgre® Modus Shelf Kit - W540 × L1530mm	1	SGRAY	604778881			217
XB2430	Firmgre® Modus Shelf Kit - W610 × 760mm	1	SGRAY	604788881			217
XB2436	Firmgre® Modus Shelf Kit - W610 × 910mm	1	SGRAY	604798881			217
XB2442	Firmgre® Modus Shelf Kit - W610 × 1070mm	1	SGRAY	604808881			217
XB2448	Firmgre® Modus Shelf Kit - W610 × 1220mm	1	SGRAY	604818881			217
XB2454	Firmgre® Modus Shelf Kit - W610 × 1380mm	1	SGRAY	604828881			217
XB2460	Firmgre® Modus Shelf Kit - W610 × 1530mm	1	SGRAY	604838881			217
XM1470	Firmgre® Mobile Post Kit - W360 × H1780mm	1	GRAY	604388881			211
XM1478	Firmgre® Mobile Post Kit - W360 × H1980mm	1	GRAY	604398881			211
XM1870	Firmgre® Mobile Post Kit - W460 × H1780mm	1	GRAY	604408881			211
XM1878	Firmgre® Mobile Post Kit - W460 × H1980mm	1	GRAY	604418881			211
XM2170	Firmgre® Mobile Post Kit - W540 × H1780mm	1	GRAY	604428881			211
XM2178	Firmgre® Mobile Post Kit - W540 × H1980mm	1	GRAY	604438881			211
XM2470	Firmgre® Mobile Post Kit - W610 × H1780mm	1	GRAY	604448881			211
XM2478	Firmgre® Mobile Post Kit - W610 × H1980mm	1	GRAY	604458881			211
XX0001	Firmgre® Corner Connector	1	GRAY	601648881			212
XX0002	Firmgre® Identification Tag 15cm	12	GRAY	601658881			212
XX0003	Firmgre® Identification Tag 7.6cm	12	GRAY	601668881			212
XX0004	Firmgre® Wall Fastener	4	SS	601678881			212
XX0005	Firmgre® Seismic Foot	4	SS	601688881			212
XX0006	Firmgre® Swivel Castors	1	GRAY	601698881			212
XX0007	Firmgre® Swivel Castors with Brake	1	GRAY	601708881			212
XX1424	Firmgre® Shelf Kit - W360 × L610mm	1	SGRAY	601248881			211
XX1430	Firmgre® Shelf Kit - W360 × L760mm	1	SGRAY	601258881			211
XX1436	Firmgre® Shelf Kit - W360 × L910mm	1	SGRAY	601268881			211
XX1442	Firmgre® Shelf Kit - W360 × L1070mm	1	SGRAY	601278881			211
XX1448	Firmgre® Shelf Kit - W360 × L1220mm	1	SGRAY	601288881			211
XX1454	Firmgre® Shelf Kit - W360 × L1380mm	1	SGRAY	601298881			211
XX1460	Firmgre® Shelf Kit - W360 × L1530mm	1	SGRAY	601308881			211
XX1472	Firmgre® Shelf Kit - W360 × L1830mm	1	SGRAY	601318881			211
XX1478	Firmgre® Shelf Kit - W360 × L1980mm	1	SGRAY	601328881			211
XX1824	Firmgre® Shelf Kit - W460 × L610mm	1	SGRAY	601338881			211
XX1830	Firmgre® Shelf Kit - W460 × L760mm	1	SGRAY	601348881			211
XX1836	Firmgre® Shelf Kit - W460 × L910mm	1	SGRAY	601358881			211
XX1842	Firmgre® Shelf Kit - W460 × L1070mm	1	SGRAY	601368881			211
XX1848	Firmgre® Shelf Kit - W460 × L1220mm	1	SGRAY	601378881			211
XX1854	Firmgre® Shelf Kit - W460 × L1380mm	1	SGRAY	601388881			211
XX1860	Firmgre® Shelf Kit - W460 × L1530mm	1	SGRAY	601398881			211
XX1872	Firmgre® Shelf Kit - W460 × L1830mm	1	SGRAY	601408881			211
XX1878	Firmgre® Shelf Kit - W460 × L1980mm	1	SGRAY	601418881			211
XX2124	Firmgre® Shelf Kit - W540 × L610mm	1	SGRAY	601428881			211
XX2130	Firmgre® Shelf Kit - W540 × L760mm	1	SGRAY	601438881			211
XX2136	Firmgre® Shelf Kit - W540 × L910mm	1	SGRAY	601448881			211
XX2142	Firmgre® Shelf Kit - W540 × L1070mm	1	SGRAY	601458881			211
XX2148	Firmgre® Shelf Kit - W540 × L1220mm	1	SGRAY	601468881			211
XX2154	Firmgre® Shelf Kit - W540 × L1380mm	1	SGRAY	601478881			211
XX2160	Firmgre® Shelf Kit - W540 × L1530mm	1	SGRAY	601488881			211
XX2172	Firmgre® Shelf Kit - W540 × L1830mm	1	SGRAY	601498881			211
XX2178	Firmgre® Shelf Kit - W540 × L1980mm	1	SGRAY	601508881			211
XX2424	Firmgre® Shelf Kit - W610 × L610mm	1	SGRAY	601518881			211
XX2430	Firmgre® Shelf Kit - W610 × L760mm	1	SGRAY	601528881			211
XX2436	Firmgre® Shelf Kit - W610 × L910mm	1	SGRAY	601538881			211
XX2442	Firmgre® Shelf Kit - W610 × L1070mm	1	SGRAY	601548881			211
XX2448	Firmgre® Shelf Kit - W610 × L1220mm	1	SGRAY	601558881			211
XX2454	Firmgre® Shelf Kit - W610 × L1380mm	1	SGRAY	601568881			211
XX2460	Firmgre® Shelf Kit - W610 × L1530mm	1	SGRAY	601578881			211
XX2472	Firmgre® Shelf Kit - W610 × L1830mm	1	SGRAY	601588881			211
XX2478	Firmgre® Shelf Kit - W610 × L1980mm	1	SGRAY	601598881			211
XY1400	Firmgre® Dunnage Stand - W360mm × H165mm	1	GRAY	601608881			211
XY1464	Firmgre® Stationary Post Kit - W360 × H1630mm	1	GRAY	601038881			211
XY1472	Firmgre® Stationary Post Kit - W360 × H1830mm	1	GRAY	601048881			211
XY1484	Firmgre® Stationary Post Kit - W360 × H2140mm	1	GRAY	601058881			211
XY1800	Firmgre® Dunnage Stand - W460mm × H165mm	1	GRAY	601618881			211
XY1864	Firmgre® Stationary Post Kit - W460 × H1630mm	1	GRAY	601098881			211

# PRODUCT INDEX

No.	Product Name	Pack	Color	Order Code	Color	Order Code	Page
XY1872	Firmgre® Stationary Post Kit - W460 × H1830mm	1	GRAY	601108881			211
XY1884	Firmgre® Stationary Post Kit - W460 × H2140mm	1	GRAY	601118881			211
XY2100	Firmgre® Dunnage Stand - W540mm × H165mm	1	GRAY	601628881			211
XY2164	Firmgre® Stationary Post Kit - W540 × H1630mm	1	GRAY	601158881			211
XY2172	Firmgre® Stationary Post Kit - W540 × H1830mm	1	GRAY	601168881			211
XY2184	Firmgre® Stationary Post Kit - W540 × H2140mm	1	GRAY	601178881			211
XY2400	Firmgre® Dunnage Stand - W610mm × H165mm	1	GRAY	601638881			211
XY2464	Firmgre® Stationary Post Kit - W610 × H1630mm	1	GRAY	601218881			211
XY2472	Firmgre® Stationary Post Kit - W610 × H1830mm	1	GRAY	601228881			211
XY2484	Firmgre® Stationary Post Kit - W610 × H2140mm	1	GRAY	601238881			211

Fits	Part Number	Part Description	Page
1021	1021-02	Lid (Specify Color)	12
	1021-03	Pin	
	1021-04	20 cm Dia Wheel	
1022	1021-02	Lid (Specify Color)	37
	1021-03	Pin	
	1021-04	20 cm Dia Wheel	
1031	1031-02	Lid (Specify Color)	13
	1031-03	Fixed Block	
	1031-04	20 cm Dia Wheel	
1032	1032-02	Lid (Specify Color)	13
	1032-03	Fixed Block	
	1031-04	20 cm Dia Wheel	
1033	1033-02	Lid (Specify Color)	13
	1033-03	Fixed Block	
	1033-04	30 cm Dia Wheel	
1034	1034-02	Lid (Specify Color)	13
	1034-03	Fixed Block	
	1033-04	30 cm Dia Wheel	
1035	1031-02	Lid (Specify Color)	14, 24
	1031-03	Fixed Block	
	1031-04	20 cm Dia Wheel	
	1035-01	Pedal	
1036	1032-02	Lid (Specify Color)	14, 24
	1032-03	Fixed Block	
	1031-04	20 cm Dia Wheel	
	1036-01	Pedal	
1037	1033-02	Lid (Specify Color)	14, 24
	1033-03	Fixed Block	
	1033-04	30 cm Dia Wheel	
	1037-01	Pedal	
1038	1034-02	Lid (Specify Color)	14, 24
	1034-03	Fixed Block	
	1033-04	30 cm Dia Wheel	
	1038-01	Pedal	
1041	1031-02	Lid (Specify Color)	13
	1031-03	Fixed Block	
	1031-04	20 cm Dia Wheel	
	1041-01	7.5 cm Dia Swivel Castor	
1042	1032-02	Lid (Specify Color)	13
	1032-03	Fixed Block	
	1031-04	20 cm Dia Wheel	
	1041-01	7.5 cm Dia Swivel Castor	
1043	1033-02	Lid (Specify Color)	13
	1033-03	Fixed Block	
	1033-04	30 cm Dia Wheel	
	1043-01	10.0 cm Dia Swivel Castor	
1044	1034-02	Lid (Specify Color)	13
	1034-03	Fixed Block	
	1033-04	30 cm Dia Wheel	
	1043-01	10.0 cm Dia Swivel Castor	
1045	1031-02	Lid (Specify Color)	14, 24
	1031-03	Fixed Block	
	1031-04	20 cm Dia Wheel	
	1035-01	Pedal	

Fits	Part Number	Part Description	Page
1045	1041-01	7.5 cm Dia Swivel Castor	14, 24
1046	1032-02	Lid (Specify Color)	14, 24
	1032-03	Fixed Block	
	1031-04	20 cm Dia Wheel	
	1041-01	7.5 cm Dia Swivel Castor	
1047	1036-01	Pedal	
	1033-02	Lid (Specify Color)	14, 24
	1033-03	Fixed Block	
	1033-04	30 cm Dia Wheel	
1048	1043-01	10.0 cm Dia Swivel Castor	
	1037-01	Pedal	
	1034-02	Lid (Specify Color)	14, 24
	1034-03	Fixed Block	
1252	1033-04	30 cm Dia Wheel	
	1043-01	10.0 cm Dia Swivel Castor	
	1038-01	Pedal	
	1252-02	Lifter	21
1253	1252-03	Pedal	
	1253-02	Lid (Specify Color)	
	174208	Soft Close	
	1253-04	Lifter	21
1254	1253-03	Pedal	
	1253-02	Lid (Specify Color)	
	174208	Soft Close	
	1254-04	Lifter	21
1255	1254-03	Pedal	
	1254-02	Lid (Specify Color)	
	174208	Soft Close	
	1254-02	Lid (Specify Color)	
1256	1254-03	Pedal	
	1254-02	Lid (Specify Color)	
	174208	Soft Close	
	1254-02	Lid (Specify Color)	
1257	1254-03	Pedal	
	1254-02	Lid (Specify Color)	
	174208	Soft Close	
	1254-02	Lid (Specify Color)	
1258	1254-03	Pedal	
	1254-02	Lid (Specify Color)	
	174208	Soft Close	
	1254-02	Lid (Specify Color)	
1259	1254-03	Pedal	
	1254-02	Lid (Specify Color)	
	174208	Soft Close	
	1254-02	Lid (Specify Color)	
1301	1301-01	Lid (Sepecify Color)	23
	1301-02	Pedal	
	1301-03	Lifter	
1302	174212	Buffer	
	1302-01	Lid (Sepecify Color)	23
	1302-02	Pedal	

# COMPONENT INDEX

Fits	Part Number	Part Description	Page
1302	1302-03	Lifter	23
	174212	Buffer	
1303	1303-01	Lid (Specify Color)	23
	1303-02	Pedal	
	1303-03	Lifter	
	174212	Buffer	
1304	1304-01	Lid (Specify Color)	23
	1304-02	Pedal	
	1304-03	Lifter	
	174212	Buffer	
1305	1305-01	Lid (Specify Color)	22
	1305-02	Pedal	
	1305-03	Lifter	
	174212	Buffer	
1306	1306-01	Lid (Specify Color)	22
	1306-02	Pedal	
	1306-03	Lifter	
	174212	Buffer	
1307	1307-01	Lid (Specify Color)	22
	1307-02	Pedal	
	1307-03	Lifter	
	174212	Buffer	
1308	1308-01	Lid (Specify Color)	22
	1308-02	Pedal	
	1308-03	Lifter	
	174212	Buffer	
1309	1309-01	Lid (Specify Color)	22
	1309-02	Pedal	
	1309-03	Lifter	
	1309-04	Castor Wheel	
1811	1811-01	Round Chassis	11, 29, 60, 61, 79
	176614	7.5 cm Dia Castor	
1812	1812-01	Square Chassis	29, 61, 187, 271
	176614	7.5 cm Dia Castor	
1813	1811-01	Round Chassis	11, 29, 61
	1813-01	7.5 cm Dia Quiet Castor	
1814	1814-01	Rectangular Chassis	20, 62, 63, 78
	176605	7.5 cm Dia Castor	
1815	1815-01	Double-compartment Chassis	20, 63
	176605	7.5 cm Dia Castor	
1816	1816-01	Tri-Compartment Chassis	20, 63
	176625	7.5 cm Dia TPR Swivel Castor with Sleeve	
1817	1817-01	Four-Compartment Chassis	20, 63
	176625	7.5 cm Dia TPR Swivel Castor with Sleeve	
1818	1818-01	Chassis	11, 29, 61
	1818-02	10 cm Dia TPR Swivel Castor	
1825	1825-01	Rectangular Chassis	62, 78
	176605	7.5 cm Dia Castor	
2011	1281-01	Inner bucket	43
	2011-01	Base (Specify Color)	
	2011-02	Tops (Specify Color)	
	2011-03	With an Ashtray Atop (Specify Color)	

Fits	Part Number	Part Description	Page
2011	2011-04	ABS Pillar (Specify Color)	43
	2011-05	Square Steel Pillar	
	2011-06	Ashtray	
2012	1281-01	Inner bucket	43
	2011-01	Base (Specify Color)	
	2011-02	Tops (Specify Color)	
	2012-01	Funnel Tops (Specify Color)	
	2011-04	ABS Pillar (Specify Color)	
	2011-05	Square Steel Pillar	
2021	1282-01	Inner bucket	43
	2021-01	Base (Specify Color)	
	2021-02	Tops (Specify Color)	
	2021-03	Funnel Tops (Specify Color)	
	2011-04	ABS Pillar (Specify Color)	
	2011-05	Square Steel Pillar	
2022	1282-01	Inner bucket	43
	2021-01	Base (Specify Color)	
	2021-02	Tops (Specify Color)	
	2022-01	Funnel Tops (Specify Color)	
	2011-04	ABS Pillar	
	2011-05	Square Steel Pillar	
2023	1282-01	Inner bucket	43
	2021-01	Base (Specify Color)	
	2023-01	Tops (Specify Color)	
	2023-02	Drum Tops (Specify Color)	
	2011-04	ABS Pillar (Specify Color)	
	2011-05	Square Steel Pillar	
2024	1282-01	Inner Bucket	43
	2021-01	Base (Specify Color)	
	2023-01	Top (Specify Color)	
	2024-01	Drum Tops with Ashtray Fixing holes (Specify Color)	
	2011-04	ABS Pillar (Specify Color)	
	2011-05	Square Steel Pillar	
2031	1283-01	Inner Bucket	43
	2021-01	Base (Specify Color)	
	2023-01	Top (Specify Color)	
	2023-02	Drum Tops (Specify Color)	
	2031-01	ABS Pillar (Specify Color)	
	2031-02	Square Steel Pillar	
2032	1283-01	Inner Bucket	43
	2021-01	Base (Specify Color)	
	2023-01	Tops (Specify Color)	
	2024-02	Drum Tops with Ashtray Fixing Hole (Specify Color)	
	2031-01	ABS Pillar (Specify Color)	
	2031-02	Square Steel Pillar	
2051	2051-01	Top Cover	44
	2051-02	Ashtray	
	2051-03	9.5 L Steel Galvanized Barrel	
2052	2052-01	Top Cover	44
	2051-03	9.5 L Steel Galvanized Barrel	

Fits	Part Number	Part Description	Page
2061	2061-01	Top Cover	44
	2061-02	Ashtray	
	2061-03	45.4 L Steel Galvanized Barrel	
2062	2062-01	Top Cover	44
	2061-03	45.4 L Steel Galvanized Barrel	
2071	2071-01	Ashtray	44
	2071-02	90.8 L Steel Galvanized Barrel	
2072	2071-02	90.8 L Steel Galvanized Barrel	44
2081	2081-01	109.8 L Steel Galvanized Barrel	44
	2081-02	Adjustable Bolt Assembly	
2082	2081-01	109.8 L Steel Galvanized Barrel	44
	2081-02	Adjustable Bolt Assembly	
2083	2081-01	109.8 L Steel Galvanized Barrel	44
	2081-02	Adjustable Bolt Assembly	
2091	2091-01	181.7 L Steel Galvanized Barrel	44
	2081-02	Adjustable Bolt Assembly	
2092	2091-01	181.7 L Steel Galvanized Barrel	44
	2081-02	Adjustable Bolt Assembly	
2093	2091-01	181.7 L Steel Galvanized Barrel	44
	2081-02	Adjustable Bolt Assembly	
2101	2101-01	Door Plank (Sepecify Color)	52
	2101-02	Base (Sepecify Color)	
	2101-03	Top (Sepecify Color)	
	2101-04	Flip Door (Sepecify Color)	
	2101-05	Key Commponents	
	2101-06	Parts Package Components	
2102	2101-01	Door Plank (Sepecify Color)	52
	2101-02	Base (Sepecify Color)	
	2102-01	Top (Sepecify Color)	
	2101-04	Flip Door (Sepecify Color)	
	2101-05	Key Commponents	
	2101-06	Parts Package Components	
2103	2101-01	Door Plank (Sepecify Color)	52
	2101-02	Base (Sepecify Color)	
	2103-01	Top (Sepecify Color)	
	2101-04	Flip Door (Sepecify Color)	
	2101-05	Key Commponents	
	2101-06	Parts Package Components	
2104	2101-01	Door Plank (Sepecify Color)	38
	2101-02	Base (Sepecify Color)	
	2101-03	Top (Sepecify Color)	
	2104-01	Flip Door (Sepecify Color)	
	2101-05	Key Commponents	
	2101-06	Parts Package Components	
2105	2101-01	Door Plank (Sepecify Color)	38
	2101-02	Base (Sepecify Color)	
	2101-03	Top (Sepecify Color)	
	2105-01	Flip Door (Sepecify Color)	
	2101-05	Key Commponents	
	2101-06	Parts Package Components	
2106	2106-01	Door Plank (Sepecify Color)	52
	2106-02	Base (Sepecify Color)	
	2106-03	Top (Sepecify Color)	

Fits	Part Number	Part Description	Page
2106	2106-04	Flip Door (Sepecify Color)	52
	2101-05	Key Commponents	
	2101-06	Parts Package Components	
2107	2106-01	Door Plank (Sepecify Color)	52
	2106-02	Base (Sepecify Color)	
	2107-01	Top (Sepecify Color)	
	2106-04	Flip Door (Sepecify Color)	
	2101-05	Key Commponents	
	2101-06	Parts Package Components	
2211	2211-01	Key Commponents (with Brush)	55
	2211-02	Special Wrench	
2212	2211-01	Key Commponents (with Brush)	56
	2211-02	Special Wrench	
2221	2211-01	Key Commponents (with Brush)	55
	2211-02	Special Wrench	
2231	2211-01	Key Commponents (with Brush)	56
	2211-02	Special Wrench	
2241	2211-01	Key Commponents (with Brush)	56
	2211-02	Special Wrench	
2242	2211-01	Key Commponents (with Brush)	56
	2211-02	Special Wrench	
2251	2251-01	Trash Barrel	57
	2251-02	Cigarette Butts Liner	
	2251-03	Cigarette Butts Cover	
2261	2211-01	Key Commponents (with Brush)	55
	2261-01	Cigarette Butts Liner	
2271	2211-01	Key Commponents (with Brush)	55
	2271-01	Cigarette Butts Liner	
2281	2211-01	Key Commponents (with Brush)	55
2291	2211-01	Key Commponents (with Brush)	55
	2291-01	Rain Cover	
2300	2300-01	Ashtray	58
2301	2301-01	Ashtray	58
2302	2302-01	Ashtray	58
2303	2301-01	Ashtray	58
2304	2300-01	Ashtray	58
2305	2302-01	Ashtray	58
2310	2300-01	Ashtray	45, 58
	2310-01	13.2 L Steel Galvanized Barrel	
2311	2301-01	Ashtray	45, 58
	2310-01	13.2 L Steel Galvanized Barrel	
2312	2302-01	Ashtray	45, 58
	2310-01	13.2 L Steel Galvanized Barrel	
2313	2301-01	Ashtray	47, 58
	2310-01	13.2 L Steel Galvanized Barrel	
2314	2300-01	Ashtray	46, 58
	2310-01	13.2 L Steel Galvanized Barrel	
2315	2302-01	Ashtray	46, 58
	2310-01	13.2 L Steel Galvanized Barrel	
2320	2320-01	56.8 L Steel Galvanized Barrel	45
2321	2320-01	56.8 L Steel Galvanized Barrel	45
2322	2320-01	56.8 L Steel Galvanized Barrel	45
2323	2320-01	56.8 L Steel Galvanized Barrel	47

# COMPONENT INDEX

Fits	Part Number	Part Description	Page
2324	2320-01	56.8 L Steel Galvanized Barrel	46
2325	2320-01	56.8 L Steel Galvanized Barrel	46
2330	2330-01	Ashtray	45, 58
	2330-02	45.4 L Steel Galvanized Barrel	
2331	2331-01	Ashtray	45, 58
	2330-02	45.4 L Steel Galvanized Barrel	
2332	2332-01	Ashtray	45, 58
	2330-02	45.4 L Steel Galvanized Barrel	
2333	2331-01	Ashtray	47, 58
	2330-02	45.4 L Steel Galvanized Barrel	
2334	2330-01	Ashtray	46, 58
	2330-02	45.4 L Steel Galvanized Barrel	
2335	2332-01	Ashtray	46, 58
	2330-02	45.4 L Steel Galvanized Barrel	
2340	2330-02	45.4 L Steel Galvanized Barrel	45
2341	2330-02	45.4 L Steel Galvanized Barrel	45
2342	2330-02	45.4 L Steel Galvanized Barrel	45
2343	2330-02	45.4 L Steel Galvanized Barrel	47
2344	2330-02	45.4 L Steel Galvanized Barrel	46
2345	2330-02	45.4 L Steel Galvanized Barrel	46
2350	2330-02	45.4 L Steel Galvanized Barrel	45
2351	2330-02	45.4 L Steel Galvanized Barrel	45
2352	2330-02	45.4 L Steel Galvanized Barrel	45
2353	2330-02	45.4 L Steel Galvanized Barrel	47
2354	2330-02	45.4 L Steel Galvanized Barrel	46
2355	2330-02	45.4 L Steel Galvanized Barrel	46
2360	2320-01	56.8 L Steel Galvanized Barrel	45
2361	2320-01	56.8 L Steel Galvanized Barrel	45
2362	2320-01	56.8 L Steel Galvanized Barrel	45
2363	2320-01	56.8 L Steel Galvanized Barrel	47
2364	2320-01	56.8 L Steel Galvanized Barrel	46
2365	2320-01	56.8 L Steel Galvanized Barrel	46
3511	3511-05	Partition	171
	3511-04	Transparent Cover	
	3511-01	Box	
	3511-02	Lid	
	3511-03	Inner Box	
3512	3511-05	Partition	171
	3511-04	Transparent Cover	
	3511-01	Box	
	3511-02	Lid	
	3511-03	Inner Box	
3711	3711-01	Supporting Base-Left	170
	3711-02	Supporting Base-Right	
	3711-03	Cover	
	4021-01	Bottom Shelf (Specify Color)	
	4021-02	Middle Shelf (Specify Color)	
	4021-03	Top Shelf (Specify Color)	
	176204	280 mm Aluminum Extrusion	
3712	3711-01	Supporting Base-Left	170
	3711-02	Supporting Base-Right	
	3711-03	Cover	
	4021-01	Bottom Shelf (Specify Color)	
	4021-02	Middle Shelf (Specify Color)	

Fits	Part Number	Part Description	Page
3712	4021-03	Top Shelf (Specify Color)	170
	176204	280 mm Aluminum Extrusion	
3713	3711-01	Supporting Base-Left	170
	3711-02	Supporting Base-Right	
	3711-03	Cover	
	4021-01	Bottom Shelf (Specify Color)	
	4021-02	Middle Shelf (Specify Color)	
	4021-03	Top Shelf (Specify Color)	
	176206	486 mm Aluminum Extrusion	
3714	3711-01	Supporting Base-Left	170
	3711-02	Supporting Base-Right	
	3711-03	Cover	
	4021-01	Bottom Shelf (Specify Color)	
	4021-02	Middle Shelf (Specify Color)	
	4021-03	Top Shelf (Specify Color)	
	176205	355 mm Aluminum Extrusion	
3715	3711-01	Supporting Base-Left	170
	3711-02	Supporting Base-Right	
	3711-03	Cover	
	4021-01	Bottom Shelf (Specify Color)	
	4021-02	Middle Shelf (Specify Color)	
	4021-03	Top Shelf (Specify Color)	
	176204	280 mm Aluminum Extrusion	
3716	3711-03	Cover	170
	4021-01	Bottom Shelf (Specify Color)	
	4021-02	Middle Shelf (Specify Color)	
	4021-03	Top Shelf (Specify Color)	
	176204	280 mm Aluminum Extrusion	
	176613	10 cm Dia Swivel Castor	
3717	3711-03	Cover	170
	4021-01	Bottom Shelf (Specify Color)	
	4021-02	Middle Shelf (Specify Color)	
	4021-03	Top Shelf (Specify Color)	
	176206	496 mm Aluminum Extrusion	
	176613	10 cm Dia Swivel Castor with Sleeve	
3718	4024-01	Right Door with Lock	170
	4024-02	Left Door	
3719	4023-01	Back Pannel (Specify Color)	170
	4023-02	Side Pannel (Specify Color)	
4010	4011-01	Bottom Shelf (Specify Color)	164, 232
	4011-03	Top Shelf (Specify Color)	
	4011-04	Handle (Specify Color)	
	176613	10 cm Dia Swivel Castor with Sleeve	
	4010-01	620 mm Aluminum Extrusion	
4011	4011-01	Bottom Shelf (Specify Color)	164, 232
	4011-02	Middle Shelf (Specify Color)	
	4011-03	Top Shelf (Specify Color)	
	4011-04	Handle (Specify Color)	
	176613	10 cm Dia Swivel Castor with Sleeve	
	4011-06	280 mm Aluminum Extrusion	
4012	4011-01	Bottom Shelf (Specify Color)	164
	4011-02	Middle Shelf (Specify Color)	
	4011-03	Top Shelf (Specify Color)	
	4013-02	Side Pannel (Specify Color)	

Fits	Part Number	Part Description	Page
4012	4011-04	Handle (Specify Color)	164
	176613	10 cm Dia Swivel Castor with Sleeve	
	176204	280 mm Aluminum Extrusion	
4013	4011-01	Bottom Shelf (Specify Color)	164
	4011-02	Middle Shelf (Specify Color)	
	4011-03	Top Shelf (Specify Color)	
	4011-04	Handle (Specify Color)	
	176613	10 cm Dia Swivel Castor with Sleeve	
	176204	280 mm Aluminum Extrusion	
	4013-01	Back Pannel (Specify Color)	
	4013-02	Side Pannel (Specify Color)	
	4013-03	Left Door	
4021	4021-01	Bottom Shelf (Specify Color)	165, 232
	4021-02	Middle Shelf (Specify Color)	
	4021-03	Top Shelf (Specify Color)	
	4221-04	Handle (Specify Color)	
	176613	10 cm Dia Swivel Castor	
	176204	280 mm Aluminum Extrusion	
	4022	4021-01	
4021-02		Middle Shelf (Specify Color)	
4021-03		Top Shelf (Specify Color)	
4021-04		Handle (Specify Color)	
4023-02		Side Pannel (Specify Color)	
176613		10 cm Dia Swivel Castor with Sleeve	
176204		280 mm Aluminum Extrusion	
4023	4021-01	Bottom Shelf (Specify Color)	165, 232
	4021-02	Middle Shelf (Specify Color)	
	4021-03	Top Shelf (Specify Color)	
	4021-04	Handle (Specify Color)	
	4023-01	Back Pannel (Specify Color)	
	4023-02	Side Pannel (Specify Color)	
	176613	10 cm Dia Swivel Castor	
	176204	280 mm Aluminum Extrusion	
	4024	4021-01	
4021-02		Middle Shelf (Specify Color)	
4021-03		Top Shelf (Specify Color)	
4021-04		Handle (Specify Color)	
4023-01		Back Pannel (Specify Color)	
4023-02		Side Pannel (Specify Color)	
4851-01		Drawer (Specify Color)	
176613		10 cm Dia Swivel Castor	
176204		280 mm Aluminum Extrusion	
4024-01		Right Door with Lock	
4024-02		Left Door	
4025	4021-01	Bottom Shelf (Specify Color)	165
	4021-02	Middle Shelf (Specify Color)	
	4021-03	Top Shelf (Specify Color)	
	4021-04	Handle (Specify Color)	
	4023-01	Back Pannel (Specify Color)	
	4023-02	Side Pannel (Specify Color)	
	4024-01	Right Door with Lock	
	4024-02	Left Door	
	176613	10 cm Dia Swivel Castor	

Fits	Part Number	Part Description	Page
4025	176204	280 mm Aluminum Extrusion	165
4026	4021-01	Bottom Shelf (Specify Color)	165
	4021-02	Middle Shelf (Specify Color)	
	4021-03	Top Shelf (Specify Color)	
	4021-04	Handle (Specify Color)	
	176613	10 cm Dia Swivel Castor	
	176204	280 mm Aluminum Extrusion	
4027	4021-01	Bottom Shelf (Specify Color)	165
	4021-02	Middle Shelf (Specify Color)	
	4021-03	Top Shelf (Specify Color)	
	4021-04	Handle (Specify Color)	
	4023-01	Back Pannel (Specify Color)	
	4023-02	Side Pannel (Specify Color)	
	4024-01	Right Door with Lock	
	4024-02	Left Door	
	176613	10 cm Dia Swivel Castor	
	176204	280 mm Aluminum Extrusion	
4031	4031-01	Top Shelf (Specify Color)	146
	4031-02	Right Pannel (Specify Color)	
	4031-03	Left Pannel (Specify Color)	
	4031-04	Bottom Shelf	
	4031-05	Middle Shelf	
	4031-06	Handle	
	4031-07	Drawer Pannel	
	4031-08	Back Pannel	
	4031-09	Adjustable Shelf	
	4031-10	Left Hinge	
	4031-11	Right Hinge	
	4031-12	Right Door	
	476620	12.7 cm Dia Rigid Castor	
	176619	12.7 cm Dia Swivel Castor w/Lock	
176981	560 mm Drawer Guaide		
4031-13	Metal Drawer		
4031-14	Lock Assembly		
4032	4031-01	Top Shelf (Specify Color)	146
	4031-02	Right Pannel (Specify Color)	
	4031-03	Left Pannel (Specify Color)	
	4031-04	Bottom Shelf	
	4031-05	Middle Shelf	
	4031-06	Handle	
	4031-08	Back Pannel	
	4031-09	Adjustable Shelf	
	4031-10	Left Hinge	
	4031-11	Right Hinge	
	4031-12	Right Door with Lock	
	4032-01	Left Door	
	176620	12.7 cm Dia Rigid Castor	
	176619	12.7 cm Dia Swivel Castor w/Lock	
4033	4031-01	Top Shelf	146
	4031-02	Right Door	
	4031-03	Left Door	
	4031-04	Bottom Shelf	
	4031-05	Middle Shelf	
	4031-06	Handle	

# COMPONENT INDEX

Fits	Part Number	Part Description	Page
4033	4031-07	Drawer Pannel	146
	4031-08	Back Pannel	
	176620	12.7 cm Dia Rigid Castor	
	176619	12.7 cm Dia Swivel Castor w/Lock	
	176981	560 mm Drawer Guaide	
	4031-14	Metal Drawer	
4041	4041-01	Top Shelf (Specify Color)	147, 236
	4041-02	Bottom Shelf (Specify Color)	
	4041-03	Right Pillar (Specify Color)	
	4041-04	Left Pillar (Specify Color)	
	4041-05	Handle (Specify Color)	
4042	4041-01	Top Shelf (Specify Color)	147
	4041-02	Bottom Shelf (Specify Color)	
	4041-03	Right Pillar (Specify Color)	
	4041-04	Left Pillar (Specify Color)	
	4041-05	Handle (Specify Color)	
	4042-01	Drawer Pannel	
	4042-02	Metal Drawer	
	176982	356 mm Drawer Guaide	
4043	4041-01	Top Shelf (Specify Color)	147
	4041-02	Bottom Shelf (Specify Color)	
	4041-03	Right Pillar (Specify Color)	
	4041-04	Left Pillar (Specify Color)	
	4041-05	Handle (Specify Color)	
	4043-01	Middle Shelf (Specify Color)	
4044	4044-01	Top Shelf (Specify Color)	147, 236
	4044-02	Bottom Shelf (Specify Color)	
	4044-03	Right Pillar (Specify Color)	
	4044-04	Left Pillar (Specify Color)	
	4041-05	Handle (Specify Color)	
4045	4045-01	Top Shelf (Specify Color)	147, 236
	4044-02	Bottom Shelf (Specify Color)	
	4041-03	Right Pillar (Specify Color)	
	4041-04	Left Pillar (Specify Color)	
	4044-05	Handle (Specify Color)	
4046	4044-01	Top Shelf (Specify Color)	147
	4044-02	Bottom Shelf (Specify Color)	
	4044-03	Right Pillar (Specify Color)	
	4044-04	Left Pillar (Specify Color)	
	4044-05	Handle (Specify Color)	
	4046-01	Middle Shelf (Specify Color)	
4047	4045-01	Top Shelf (Specify Color)	147
	4044-02	Bottom Shelf (Specify Color)	
	4044-03	Right Pillar (Specify Color)	
	4044-04	Left Pillar (Specify Color)	
	4044-05	Handle (Specify Color)	
	4046-01	Middle Shelf (Specify Color)	
4051	4051-01	Bottom Shelf	148
	4051-02	Front cover	
	4051-03	Center cover	
	4051-04	Rear cover	
	4051-05	Middle Shelf	
	4051-06	Stopper	
	4051-07	Lid	

Fits	Part Number	Part Description	Page
4051	4051-08	Front Steel Frame Welding Assembly	148
	4051-09	Rear Steel Frame Welding Assembly	
	4051-10	Center Connection Steel Pipe	
	4051-11	Bottom Connection Steel Pipe	
	176619	12.7 cm Dia Swivel Castor w/Lock	
	176620	12.7 cm Dia Rigid Castor	
	4411	4411-01	
176307	Handle		
176602	15 cm Dia Swivel Castor		
176601	15 cm Dia Rigid Castor		
4412	4411-01	Platform	152
	176307	Handle	
	176604	15 cm Dia Swivel Castor	
	176603	15 cm Dia Rigid Castor	
4413	4413-01	Platform	152, 232
	176307	Handle	
	176608	20 cm Dia Swivel Castor	
	176607	20 cm Dia Rigid Castor	
4414	4413-01	Platform	152
	176307	Handle	
	176610	20 cm Dia Swivel Castor	
	176609	20 cm Dia Rigid Castor	
4415	4413-01	Platform	152
	176307	Handle	
	176610	20 cm Dia Swivel Castor	
	176609	20 cm Dia Rigid Castor	
4416	4416-01	Platform	152
	4416-02	Handle	
	176608	20 cm Dia Swivel Castor	
	176607	20 cm Dia Rigid Castor	
4417	4416-01	Platform	152
	4416-02	Handle	
	176610	20 cm Dia Swivel Castor	
	176609	20 cm Dia Rigid Castor	
4418	4416-01	Platform	152
	4416-02	Handle	
	176612	20 cm Dia Swivel Castor	
	176611	20 cm Dia Rigid Castor	
4461	4411-01	Platform	156
	4461-01	Front Fence	
	4461-02	Side Fence	
	176601	15 cm Dia Rigid Castor	
4462	4413-01	Platform	156
	4462-01	Front Fence	
	4462-02	Side Fence	
	176609	20 cm Dia Rigid Castor	
4463	4413-01	Platform	156
	4462-01	Front Fence	
	4462-02	Side Fence	
	176607	20 cm Dia Rigid Castor	
4464	176608	20 cm Dia Swivel Castor	156
	4416-01	Platform	

Fits	Part Number	Part Description	Page
4464	4464-01	Front Fence	156
	4464-02	Side Fence	
	176609	20 cm Dia Rigid Castor	
	176610	20 cm Dia Swivel Castor	
4465	4416-01	Platform	156
	4464-01	Front Fence	
	4464-02	Side Fence	
	176607	20 cm Dia Rigid Castor	
	176608	20 cm Dia Swivel Castor	
4471	4411-01	Platform	155
	4471-01	Supporting Base	
	4471-02	Steel Components	
	176607	20 cm Dia Rigid Castor	
4472	4413-01	Platform	155
	4471-01	Supporting Base	
	4472-01	Steel Components	
	176607	20 cm Dia Rigid Castor	
4473	441601	Platform	155
	4471-01	Supporting Base	
	4473-01	Steel Components	
	176607	20 cm Dia Rigid Castor	
4474	4474-01	Handle	155
	4474-02	20 cm Dia Single Castor	
4481	4481-01	Platform	156, 238
	4481-02	Handle	
	176625	7.6 cm Dia Swivel Castor with Sleeve	
4482	4481-01	Platform	156, 238
	4481-02	Handle	
	4482-01	10 cm Dia Swivel Castor	
4483	4483-01	Body	157, 171, 186
	176640	10 cm TPR Flat Bottom Universal Wheel	
4484	4484-01	Body	238, 251
	176613	10 cm Dia Swivel Castor with Sleeve	
4485	4484-01	Body	238, 251
	176613	10 cm Dia Swivel Castor with Sleeve	
	4485-01	Handle	
4491	4491-01	Pad	175, 185
	4492-02	Supporting Base	
4492	4492-01	Pad (122x91 cm)	175, 185
	4492-02	Supporting Base	
4493	4493-01	Pad	175, 185
	4492-02	Supporting Base	
4512	4512-02	10 cm Swivel Castor	160
4522	4522-01	Body Skeleton	160
	4522-02	Body Handle	
	4522-03	30 cm Dia Wheel	
	4522-04	12.5 cm Dia Swivel Castor	
4532	4522-01	Body Skeleton	160
	4522-02	Body Handle	
	4522-03	30 cm Dia Wheel	
	4532-02	12.5 cm Dia Swivel Castor	
	4532-03	Bolt Kits	
4542	4542-01	Body Skeleton	161

Fits	Part Number	Part Description	Page
4542	4522-02	Body Handle	161
	4522-03	30 cm Dia Wheel	
	4532-02	12.5 cm Dia Swivel Castor	
4711	176666	12.5 cm Dia Heavy-duty TPR Swivel Castor	158, 187
	176665	12.5 cm Dia Heavy-duty TPR Directional Castor	
	176319	Backplane Supporting Base	
4712	176320	Backplane	158
	176666	12.5 cm Dia Heavy-duty TPR Swivel Castor	
	176665	12.5 cm Dia Heavy-duty TPR Directional Castor	
4714	176319	Backplane Supporting Base	158, 187
	176320	Backplane	
	4712-01	Steel Frame	
5011	176666	12.5 cm Dia Heavy-duty TPR Swivel Castor	158, 187
	176665	12.5 cm Dia Heavy-duty TPR Directional Castor	
	4714-02	Backplane Supporting Base	
5011	4714-03	Backplane	76
	5011-01	Bottom Shelf	
	5011-02	Middle Shelf	
5019	5011-03	Top Shelf	77
	5011-04	Handle	
	5011-05	Rear Pillar	
	5011-06	Left Side of Pillar	
	5011-07	Right Side of Pillar	
	176613	10 cm Dia Swivel Castor	
	5019-01	Front Pannel	
5019-02	Left Pannel		
5019-03	Right Pannel		
5019-04	Back Pannel		
5019-05	Key Commponents		
5021	5011-07	Right Side of Pillar	68
	176613	10 cm Dia Swivel Castor	
	5021-01	Top Shelf (Specify Color)	
	5021-02	Bottom Shelf (Specify Color)	
	5021-03	Side Plate A (Specify Color)	
	5021-04	Side Plate B (Specify Color)	
	5021-05	Middle Shelf (Specify Color)	
	5021-06	Bottom Plate (Specify Color)	
	5021-07	Backplane (Specify Color)	
	176768	Vacuum Shelf Components	
	176769	Garbage Bag Buckle	
	5021-08	Crash Wheel Assembly	
	176615	20 cm Dia Swivel Castor w/Lock	
	176616	20 cm Dia Rigid Castor	
179714	Vinyl Bag		
5021-09	Kit (Including Screw, Bolts)		
5022	5021-01	Top Shelf (Specify Color)	68
	5021-02	Bottom Shelf (Specify Color)	
	5021-03	Side plate A (Specify Color)	
	5021-04	Side plate B (Specify Color)	
	5021-05	Middle Shelf (Specify Color)	
	5021-06	Bottom Pannel (Specify Color)	
	5021-07	Backplane (Specify Color)	
	176768	Vacuum Shelf Components	
	176769	Garbage Bag Buckle	
	5021-08	Crash Wheel Assembly	
	176615	20cm Dia Swivel Castor w/Lock	

# COMPONENT INDEX

Fits	Part Number	Part Description	Page
5022	176616	20 cm Dia Rigid Castor	68
	179714	Vinyl Bag	
	5021-09	Kit (Including Screw, Bolts)	
	5022-01	Left Door	
	5022-02	Right Door with Lock	
5023	5021-01	Top Shelf (Specify Color)	68
	5021-02	Bottom Shelf (Specify Color)	
	5021-03	Side Plate A (Specify Color)	
	5021-04	Side Plate B (Specify Color)	
	5021-05	Middle Shelf (Specify Color)	
	5021-06	Bottom Pannel (Specify Color)	
	5021-07	Backplane (Specify Color)	
	176768	Vacuum Shelf Components	
	176769	Garbage Bag Buckle	
	5021-08	Crash Wheel Assembly	
	176615	20 cm Dia Swivel Castor w/Lock	
	176616	20 cm Dia Rigid Castor	
	179714	Vinyl Bag	
	5021-09	Kit (Including Screw, Bolts)	
	5022-01	Left Door	
	5022-02	Right Door	
	5027-01	Movable Door	
5027-02	Security Hood		
5031	5031-01	Top Shelf (Specify Color)	70
	5031-02	Bottom Shelf (Specify Color)	
	5031-03	Side Plate A (Specify Color)	
	5031-04	Side Plate B (Specify Color)	
	5031-05	Middle Shelf (Specify Color)	
	5031-06	Backplane (Specify Color)	
	176768	Vacuum Shelf Components	
	176769	Garbage Bag Buckle	
	5021-08	Crash Wheel Assembly	
	176615	20 cm Dia Swivel Castor w/Lock	
	176616	20 cm Dia Rigid Castor	
	5031-07	Kit (Including Screw, Bolts)	
	5041	176641	
179717		Linen Bag	
5042	176641	10 cm Dia Swivel Castor	82
	5042-01	Linen Bag	
5051	5051-01	Bottom Shelf (Specify Color)	70
	5051-02	Top Shelf (Specify Color)	
	5051-03	Left Side Plate (Specify Color)	
	5051-04	Right Side Plate (Specify Color)	
	5051-05	Middle Shelf A (Specify Color)	
	5051-06	Middle Shelf B (Specify Color)	
	5051-07	Backplane (Specify Color)	
	5051-08	18 cm Dia Swivel Castor w/Lock	
	5051-09	18 cm Dia Rigid Castor	
	5051-10	Vinyl Bag	
	5051-11	Vacuum shelf components	
	5051-12	Garbage Bag Buckle	
	5051-13	Crash Wheel Assembly	
5211	5211-01	Body (Specify Color)	84
	5211-02	Base (Specify Color)	

Fits	Part Number	Part Description	Page
5211	5211-03	Water Tank	84
	5211-04	Bucket (Specify Color)	
	5211-05	Right Cover (Specify Color)	
	5211-06	Left Cover (Specify Color)	
	5211-07	Platen	
	5211-08	Baffle Plate	
	5211-09	Left Rack	
	5211-10	Right Rack	
	5211-11	Left Gear	
	5211-12	Right Gear	
	5211-13	Valve	
	5211-14	Cover for Valve	
	5211-15	Cover Plate	
	5211-16	Handle for Body	
	5211-17	Fastner	
	5211-18	Handle for Pressure Bar	
	176416	Spring	
	5221	5221-01	
176984		Handle for Bucket	
176605		7.6 cm Swivel Castor	
5223	5223-01	Body (Specify Color)	85
	5223-02	Squeeze Water Basket (Specify Color)	
	5223-03	Squeeze Water Plate (Specify Color)	
	5223-04	Fixed Part-Left	
	5223-05	Fixed Part-Right	
	5223-06	Handle	
	176344	Strut Components	
	176417	Torsion Spring	
	176984	Handle for Bucket	
	176605	7.6 cm Swivel Castor	
5224	5224-01	Body (Specify Color)	85, 86, 87
	176356	Handle for Bucket	
	176605	7.6 cm Swivel Castor	
5226	5226-01	Body (Specify Color)	85
	5226-02	Squeeze Water Basket (Specify Color)	
	5226-03	Squeeze Water Plate (Specify Color)	
	176354	Strut Components	
	176355	Torsion Spring	
	176356	Handle for Bucket	
	176605	7.6 cm Swivel Castor	
5228	5226-01	Body (Specify Color)	86
	5227-01	Squeeze Water Basket (Specify Color)	
	5227-02	Left Cover (Specify Color)	
	5227-03	Right Cover (Specify Color)	
	5227-04	Left Rack	
	5227-05	Right Rack	
	5227-06	Gear	
	5227-07	Strut Components	
	5227-08	Torsion Spring	
	176605	7.6 cm Swivel Castor	
5229	5229-01	Body (Specify Color)	85, 86, 87
	5229-02	Handle for Bucket	
	176605	7.6 cm Swivel Castor	
5281	5281-01	Bronze Drum	88

Fits	Part Number	Part Description	Page
5281	5281-02	Tension Spring	88
	5281-03	Castor Components	
5300	5229-01	Body (Specify Color)	85
	5226-02	Squeeze Water basket (Specify Color)	
	5226-03	Squeeze Water plate (Specify Color)	
	176354	Strut Components	
	176355	Torsion Spring	
	5229-02	Handle for Bucket	
	176605	7.6 cm Swivel Castor	
5301	5229-01	Body (Specify Color)	86
	5227-01	Squeeze Water Basket (Specify Color)	
	5227-02	Left Cover (Specify Color)	
	5227-03	Right Cover (Specify Color)	
	5227-04	Left Rack	
	5227-05	Right Rack	
	5227-06	Gear	
	5227-07	Strut Components	
	5227-08	Torsion Spring	
	176605	7.6 cm Swivel Castor	
	5310	5310-01	Chassis
1813-01		7.5 cm Dia Quiet Castor	
5311	5310-01	Chassis	87
	1813-01	7.5 cm Dia Quiet Castor	
	5226-01	Body (Specify Color)	
	5226-02	Squeeze Water basket (Specify Color)	
	5226-03	Squeeze Water plate (Specify Color)	
	176354	Strut Components	
	176355	Torsion Spring	
	176356	Handle for Bucket	
5263-01	Dirty Water Bucket (Specify Color)		
5312	5310-01	Chassis	87
	1813-01	7.5 cm Dia Quiet Castor	
	5226-01	Body (Specify Color)	
	5227-01	Squeeze Water basket (Specify Color)	
	5227-02	Left Cover (Specify Color)	
	5227-03	Right Cover (Specify Color)	
	5227-04	Left Rack	
	5227-05	Right Rack	
	5227-06	Gear	
	5227-07	Strut Components	
	5227-08	Torsion Spring	
5263-01	Dirty Water Bucket (Specify Color)		
6851	6851-01	Steel Components	116
6852	6851-01	Bracket Components	116
6853	6851-01	Bracket Components	117
6861	6861-01	Broom Connector Components	116
6862	6861-01	Connector Components	116
6863	6861-01	Connector Components	117
6871	6851-01	Steel Components	116
	6861-01	Broom Connector Components	
6872	6851-01	Bracket Components	116
	6861-01	Connector Components	
6873	6851-01	Bracket Components	117
	6861-01	Connector Components	

Fits	Part Number	Part Description	Page	
6881	6851-01	Bracket Components	116	
	6861-01	Connector Components		
6882	6851-01	Bracket Components	116	
	6861-01	Connector Components		
6883	6851-01	Bracket Components	117	
	6861-01	Connector Components		
6891	6851-01	Bracket Components	116	
	6861-01	Connector Components		
6892	6851-01	Bracket Components	116	
	6861-01	Connector Components		
6893	6851-01	Bracket Components	117	
	6861-01	Connector Components		
6911	6912-01	Body	126	
	6911-01	Moving Part		
	6912-04	Wheel		
	6912-05	Handle with Hook		
	6912-01	Body	126	
6912	6912-01	Body	126	
	6912-02	Activities Cover		
	6912-03	Moving Part		
	6912-04	Wheel		
	6912-05	Handle with Hook		
6913	6912-01	Body	126	
	6912-02	Activities Cover		
	6912-03	Moving Part		
	6912-04	Wheel		
	6913-01	Handle without Hook		
6914	6912-01	Body	126	
	6911-01	Moving Part		
	6912-04	Wheel		
	6913-01	Handle without Hook		
	6932	6932-01	Top of the Pedal (Specify Color)	134, 174
	6932-02	Left Support Plate (Specify Color)		
	6932-03	Right Support Plate (Specify Color)		
	6932-04	Non-slip Pad-Left		
	6932-05	Non-slip Pad-Right		
6933	6933-01	Pedal (Specify Color)	134, 174	
	6933-02	Wheel Components		
8011	8011-01	Seat (Specify Color)	256	
	8011-02	Left Bracket (Specify Color)		
	8011-03	Right Bracket (Specify Color)		
	8011-04	Bracket Connecting Rod-Front		
	8011-05	Bracket Connecting Rod-Rear		
	8011-06	Bracket for Sear		
	161267	Safety Belt-A		
	161268	Safety Belt-B		
	8012	8011-01	Seat (Specify Color)	256
		8011-02	Left Bracket (Specify Color)	
		8011-03	Right Bracket (Specify Color)	
8011-04		Bracket Connecting rod-Front		
8011-05		Bracket Connecting rod-Rear		
8011-06		Bracket for Seat		
161267		Safety Belt-A		
161268		Safety Belt-B		
176606		5 cm Dia Swivel Castor with Sleeve		

# COMPONENT INDEX

Fits	Part Number	Part Description	Page
8411	8411-01	Body	184
	8411-02	Top	
	8411-03	Transparent Cover	
	8411-04	Spoon Rack	
	8411-05	7.6 cm Dia Swivel Castor	
	8411-06	7.6 cm Dia Rigid Castor	
8412	8412-01	Body	184
	8412-02	Top	
	8412-03	Transparent cover	
	8411-04	Spoon Rack	
8412	8411-05	7.6 cm Dia Swivel Castor	184
	8411-06	7.6 cm Dia Rigid Castor	
8413	8413-01	Body	184
	8413-02	Top	
	8413-03	Transparent Cover	
	8411-04	Spoon Rack	
	8411-05	7.6 cm Dia Swivel Castor	
	8411-06	7.6 cm Dia Rigid Castor	
8418	8418-01	Top	185
	8418-02	Transparent Cover	
	8418-03	Divider plate	
8419	8419-01	Top	185
	8419-02	Transparent Cover	
	8419-03	Divider plate	
8420	8420-01	Top	185
	8420-02	Transparent Cover	
	8420-03	Divider plate	
8441	8441-01	Body	255
	8441-02	Cover	
	8441-03	0.9 L Insert	
8442	8441-01	Body	255
	8441-02	Cover	
	8442-01	0.7 L Insert	
8443	8441-01	Body	255
	8441-02	Cover	
	8443-01	0.5 L Insert	
8613	8613-01	Storage Rack Body (Specify Color)	230
	8613-02	Top (Specify Color)	
	8613-03	Round Aluminum Alloy Tube	
	8613-04	Square Aluminum Alloy Tube	
	8613-05	D Shape Aluminum Alloy Tube	
	176632	12.5 cm Dia TPR Swivel Castor w/Lock	
	176631	12.5 cm Dia TPR Swivel Castor	
	8614	8613-01	
8614	8613-02	Top (Specify Color)	230
	8614-01	Round Aluminum Alloy Tube	
	8614-02	Square Aluminum Alloy Tube	
	8614-03	D shape Aluminum Alloy Tube	
	176632	12.5cm Dia TPR Swivel Castor w/Lock	
	176631	12.5cm Dia TPR Swivel Castor	
	8615	8613-01	
8613-02		Top (Specify Color)	
8615-01		Round Aluminum Alloy Tube	
8615-02		Square Aluminum Alloy Tube	

Fits	Part Number	Part Description	Page
8615	8615-03	D Shape Aluminum Alloy Tube	230
	176632	12.5 cm Dia TPR Swivel Castor w/Lock	
	176631	12.5 cm Dia TPR Swivel Castor	
8621	8621-01	Storage Rack Body (Specify Color)	230
	8613-02	Top (Specify Color)	
	8613-03	Round Aluminum Alloy Tube	
	8613-04	Square Aluminum Alloy Tube	
	8613-05	D Shape Aluminum Alloy Tube	
	176632	12.5 cm Dia TPR Swivel Castor w/Lock	
8622	8621-01	Storage Rack Body (Specify Color)	230
	8613-02	Top (Specify Color)	
	8614-01	Round Aluminum Alloy Tube	
	8614-02	Square Aluminum Alloy Tube	
	8614-03	D Shape Aluminum Alloy Tube	
	176632	12.5 cm Dia TPR Swivel Castor w/Lock	
8651	8651-01	Separation Column (with Bolt Assembly)	231
	8651-02	Knob	
	8651-03	Dust Cover	
	8651-04	12.5 cm Dia Swivel Castor w/Lock	
	8651-05	12.5 cm Dia Swivel Castor	
8888	8888-01	Rectangular Chassis	157, 228
	176640	10 cm TPR Flat Bottom Universal Wheel	
8889	8889-01	Rectangular Chassis	157, 228
	176640	10 cm TPR Flat Bottom Universal Wheel	

# Stemware and Glass Sizing Reference Guide

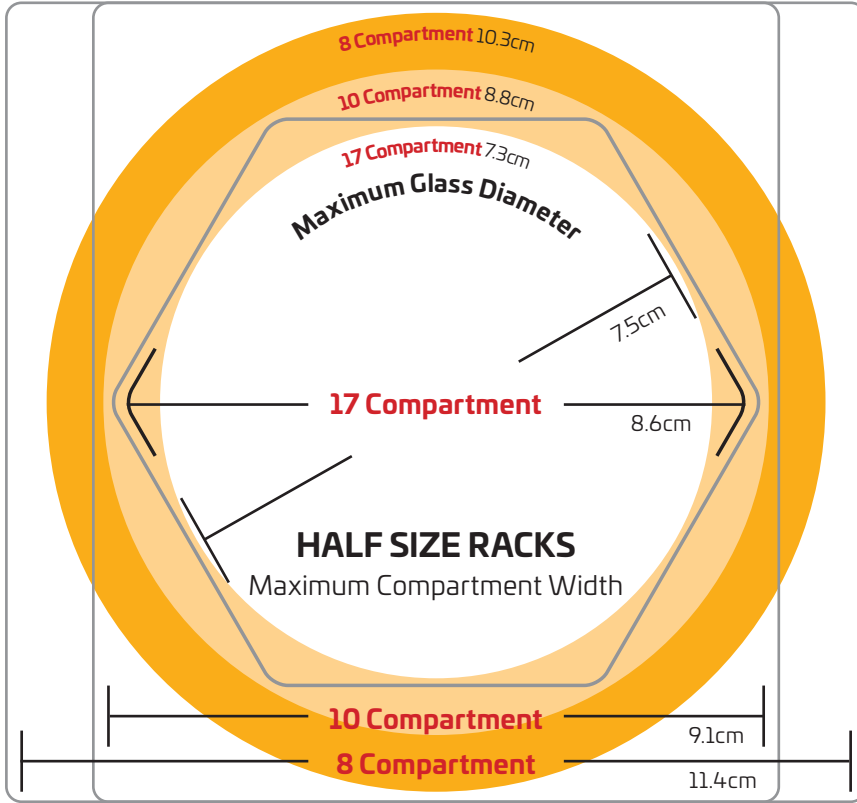

Use the vertical guide on the right to determine item height and the number of extenders that should be used.

Use the two circular guides to determine which rack should be used based on the diameter of the glass or stemware.

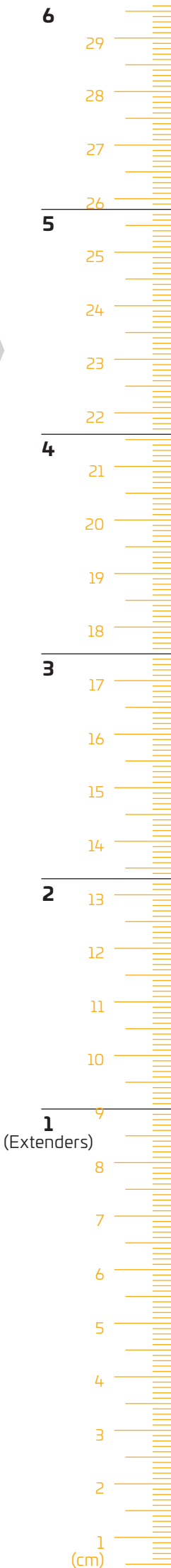
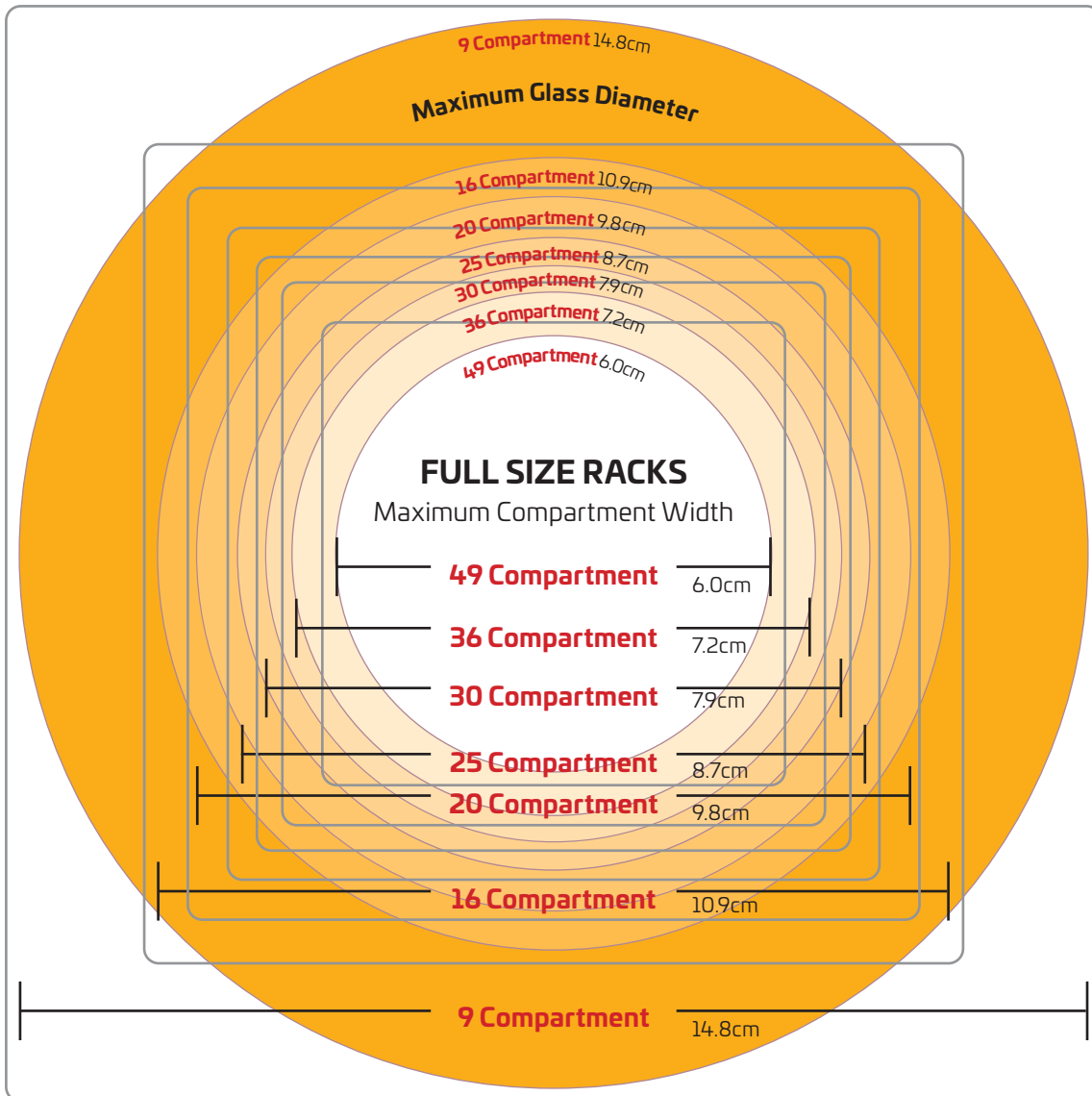



## **Trust Commercial Products Co.,Ltd**

Add: 143 Fanrong Road, Yuanqiao, Huangyan,  
Taizhou, Zhejiang, China 318025

Tel: +86 576-8489 9988

Fax: +86 576-8488 9878

[info@trustcommercial.com](mailto:info@trustcommercial.com)

[www.trustcommercial.com](http://www.trustcommercial.com)

**Dealer**